

# NELSON TASMAN EROSION AND SEDIMENT CONTROL GUIDELINES

JULY 2019



---

# Erosion and Sediment Control Guidelines

---

Control your sediment. Protect your project.  
Safeguard our environment.

## Chapter 1 Acknowledgements and Introduction



# TABLE OF CONTENTS

<b>ACKNOWLEDGEMENTS</b> .....	<b>i</b>
<b>FOREWORD</b> .....	<b>ii</b>
<b>1 INTRODUCTION</b> .....	<b>3</b>
<b>1.1 Advantages of Erosion and Sediment Control</b> .....	<b>4</b>
<b>1.2 Council Expectations</b> .....	<b>5</b>
<b>1.3 Industry Specific Guidelines</b> .....	<b>5</b>
<b>1.4 Regulatory Context</b> .....	<b>6</b>
<b>1.5 Tasman Resource Management Plan (TRMP)</b> .....	<b>6</b>
1.5.1 TRMP Policies and Objectives .....	7
1.5.2 TRMP Rules – under review .....	7
<b>1.6 Nelson Resource Management Plan (NRMP)</b> .....	<b>9</b>
1.6.1 NRMP Policies and Objectives .....	10
1.6.2 NRMP Rules .....	10
<b>1.7 Subdivision</b> .....	<b>10</b>
<b>1.8 Nelson Tasman Land Development Manual (NTLDM)</b> .....	<b>11</b>

## LIST OF TABLES

Table 2-1 Tasman Resource Management Plan - Document Structure .....	8
Table 2-2 Nelson Resource Management Plan – Document Structure .....	11

## LIST OF FIGURES

Figure 2-1 Excessive sediment in Field Creek due to poor site erosion and sediment control.....	3
Figure 2-2 Kaihoka Lakes, Owen River; Waimea Estuary, Kaiteriteri Beach (T. James); Parapara Beach (R.Scherer).....	4



## ACKNOWLEDGEMENTS

The Tasman District Council would like to thank Earl Shaver of Aqua Terra International for assistance in developing this document and to acknowledge the Auckland Council, the NZ Transport Agency, Tauranga City Council, Waikato Regional Council, Canterbury Regional Council, Bay of Plenty Regional Council, Ridley Dunphy Environmental Limited, the Maryland Department of the Environment, Maryland State Highway Administration and Southern Skies Environmental Ltd, for use of photographs, figures, text and the Glossary text.

Their assistance is most appreciated.

The following people have been involved in preparation and review of this document:

Document Preparation		Document Review
<b>Tasman District Council:</b>		A further review will be undertaken with industry 2020.
Lisa McGlinchey	Team Leader Policy - Natural Resources) – <i>editor</i>	
Pauline Webby	(Policy Planner - Natural Resources) – <i>editor</i>	
Dave Shaw	(Compliance & Investigations)	
Mary-Anne Baker	(Policy Planner)	
Andrew Burton	(Land Resource Scientist)	
Trevor James	(Environmental Resource Scientist)	
Dugald Ley	(Development Engineer)	
Leif Pigott	(Natural Resource Consents)	
Ian McComb	(Activity Planning Advisor)	
Warren Galbraith	(Compliance & Investigations)	
Paul Sheldon	(Contaminants Resource Scientist)	
<b>Other:</b>		
Earl Shaver	(Aqua Terra International)	
Graeme Ridley	(Ridley Dunphy Environmental Ltd) (Peer reviewer)	

### Document Review

This guideline will be reviewed regularly to allow inclusion of new methods and technologies as accepted best practice changes. With this process in mind, it is important that those undertaking land disturbance in Tasman provide feedback on any issues they have with implementation of any methods and technologies recommended in this guideline, as well as sharing experience of using any new methods or technologies that become available.

#### **How can I provide feedback on this guideline?**

For your comments and suggestions, please use the feedback form downloadable from the erosion and sediment control webpage and email to [pauline.webby@tasman.govt.nz](mailto:pauline.webby@tasman.govt.nz).

#### **How will I be advised of updates to the guideline?**

This guideline is a living document and updates will be made, as required, to the web version available on NCC and Tasman District Council's webpage. Hard copies will not be sold or officially issued. It is the responsibility of the user of this guideline to ensure they download the most up to date version of this guideline.

Version control	Document Review
V1 July 2019	Complete

## FOREWORD

Tasman District Council and Nelson City Council are committed to the reduction of stormwater runoff effects including sediment discharges from subdivisions, developments and land disturbance activities. Throughout this guideline reference is made to land disturbance activities, rather than earthworks, to provide a broader context for application.

The current Tasman Resource Management Plan (TRMP) defines the term ‘land disturbance’ which means:

- **The destruction or removal of vegetation** [including trees, shrubs, plants, or grasses], for example, by logging of forests or clearance of scrub by spraying, burning or mechanical means;
- **Soil disturbance** [meaning the disturbance of soil other than by modification of the shape of the ground surface and includes cultivation, deep ripping, mole ploughing, root raking, blading, and compaction by vehicles or stocking, and excludes earthworks], OR
- **Earthworks** [meaning any modification to the shape of the ground surface by movement or removal of soil and includes excavation, infilling, recontouring [meaning any earthworks that result in the reshaping, raising, or lowering of the surface of a more or less continuous area of ground], and construction of any road, track, embankment, or drainage channel] and includes for example building sites, pits or quarries.

The Nelson Resource Management Plan (NRMP) does not define use the term land disturbance, but the following defined terms relate to the disturbance of land:

- **Vegetation clearance** means disturbance of soil other than by modification to the shape of the land surface and includes cultivation, deep ripping, root raking, blading and compaction, the term earthworks is utilised.
- **Soil disturbance** means disturbance of soil other than by modification to the shape of the land surface and includes cultivation, deep ripping, root raking, blading and compaction.

Earthworks means any modification to the shape of the land surface, including removal of soil, excavation, infilling, re-contouring and construction of any road, track, landing or drainage channel [‘Landfill’ has a separate (refer definition). of ‘Landfill’].

For the purposes of this guide “**earthworks**” has the same meaning as **land disturbance**.

This guideline is intended for use when undertaking the following activities whenever they include land disturbance:

- |  |   |
|--|---|
| <ul style="list-style-type: none"> <li>• Subdivision development</li> <li>• Building work, including site preparation</li> <li>• Road and track construction and maintenance</li> <li>• Drainage construction and maintenance</li> </ul> | <ul style="list-style-type: none"> <li>• Utility construction and maintenance</li> <li>• Quarrying</li> <li>• Works in or adjacent to waterways</li> <li>• Farming</li> </ul> |
|--|---|

**Note:**

Plantation forestry activities are managed by the National Environmental Standard Plantation Forestry (NESPF).

This Erosion and Sediment Control Guide provides the Councils and land use managers with detailed design guidance and information about what constitutes best practice for erosion and sediment control for land disturbing activities in the Nelson/Tasman Districts.

Some industries have erosion and sediment control guidelines specific to their activities which cover industry specific issues and best practice methods. Industry specific guidelines can be used in conjunction with this guideline provided they are appropriate to the Nelson/Tasman region's soils and climate and employ best practice methods to the same or greater standard than identified in this guideline.

If you have any doubt as to which guidelines are appropriate for your activity, please contact the Council to discuss.

The policies and rules in the TRMP and the NRMP should be read by those intending any activity that disturbs natural ground cover to identify the status of a particular project for consenting requirements or permitted activity conditions.

The choice of compliance and the level of best practice adopted, sits with those undertaking land disturbance. Councils can set and enforce regulations, but it is individuals who choose to be proactive and think about how they can effectively manage erosion and sediment on their properties that will make all the difference to the quality of our streams, wetlands, estuaries and beaches.

## 1 INTRODUCTION

Sediment from land disturbance activities can have significant detrimental impacts on receiving systems including adjacent properties, rivers, lakes, freshwater wetlands, estuaries, harbours and coasts. It also represents the loss of valuable soils, particularly where eroded from productive land.



Adverse impacts from land disturbance activities are caused by the dislodgement and transport of sediment by water or wind from areas where soil is exposed. Suspended sediments are transported off site and deposited downstream, particularly in low energy, slow flowing areas.

Adverse impacts on aquatic ecosystems usually result from excessive levels of fine sediment in the water column and on and in the bed with some environments being more sensitive than others - for example estuaries, freshwater wetlands and spring-fed, gravel-bed streams.

Figure 1-1 Excessive sediment in Field Creek due to poor site erosion and sediment control

Wind erosion can cause significant dislodgement and transport of sediment. This causes nuisance and adverse amenity effects and can affect human health, as well as subsequently causing adverse effects on water quality upon settling.

Discussion of adverse impacts is further explored in Chapter 3 on land disturbance issues and Chapter 4 on receiving environments.

The national annual cost of erosion and sedimentation in New Zealand has been estimated to be well over \$100 million per year (Krausse et al. 2001). However, this figure does not include less-tangible effects like water quality decline and biodiversity loss.

There are numerous sources of sediment; some natural and some caused by human activities. As accelerated sediment discharge from development, farming, horticulture and forestry has potential for significant adverse impacts to receiving systems, the Council has developed this best practice guideline for earthworks and land disturbing activities. This document has been based on other guidelines in use around New Zealand but includes information and issues specific to the Nelson and Tasman region.

The following considerations will need to be factored into any erosion and sediment control plan. Plans should use erosion and sediment control practices included in this guideline:

- Climate
- Soils, including specific consideration of vulnerable soils in Tasman
- Slope
- Size of disturbance
- Receiving system that the project drains into
- Effectiveness of the practice, and
- Regulatory requirements of the Council.

This guideline incorporates the above items into the criteria for both erosion and sediment control practices and provides guidance on specific situations where a given practice is appropriate and how to size the practice. It is also recognised that no control practice is 100% effective and that some of the key elements in reducing sediment discharge come from good site management, in particular limiting the size and duration of disturbed areas and stabilising exposed soils as soon as possible. As such, this guideline also incorporates recommended principles for consideration during design and planning phases to help minimise sediment generation.

There have been a number of local studies that conclude that sediment is a contaminant of concern in the Tasman District (Young et al 2010). Tasman district has some of the clearest river water in New Zealand. With clear water it takes far less sediment to cause an effect on amenity values that is “conspicuous”. Tasman and Nelson also have a number of estuaries which are vulnerable to the discharges from the urban centres and rural areas which drain to them and which are already under pressure from sedimentation. The key land disturbing activities in both regions are forestry, farming and urban development. Within urban areas the key activities of concern are subdivision developments and building construction.

With careful planning, design and implementation, adverse effects of sediment discharges resulting from land disturbances, construction and maintenance activities can be avoided or minimised, helping to protect our iconic streams, rivers, wetlands, estuaries and beaches.



Figure 1-2 Kaihoka Lakes, Owen River; Waimea Estuary, Kaiteriteri Beach (T. James); Parapara Beach (R.Scherer)

## 1.1 Advantages of Erosion and Sediment Control

Careful pre-planning and implementation of erosion and sediment controls usually results in many on-site advantages, in addition to protecting the environment.

Environmental benefits include:

- Reduced risk of damage to aquatic ecosystems
- Improved appearance of the site and downstream waters
- Reduced water treatment costs for water users
- Reduced blockage of drains, and
- Less mud dropped or washed onto roads.

On-site benefits can typically include:

- Improved drainage and reduced site wetness
- Less dust problems
- Improved working conditions
- Reduced downtime after rain
- Less stockpile losses
- Reduced clean-up costs
- Earlier works completion
- Less chance of public complaints, and
- Less chance of failed compliance assessments, minimising risk of works stoppages and potential fines.

## 1.2 Council Expectations

Tasman District Council and Nelson City Council (NCC) promote the following methods to achieving good land disturbance management and protection of water quality in the region:

- Erosion and Sediment Control Plans
- Use of Best Practicable Option
- A 'Treatment Train' approach to sediment management
- Good site management (non-structural practices and behaviours eg. staging)
- Discharge standards.

The Resource Management Act 1991 (RMA) defines 'Best Practicable Option' as:

*"Best Practicable Option, in relation to a discharge of a contaminant or an emission of noise, means the best method for preventing or minimising the adverse effects on the environment having regard, among other things, to:*

- (a) *The nature of the discharge or emission and the sensitivity of the receiving environment to adverse effects; and*
- (b) *The financial implications, and the effects on the environment, of that option when compared with other options; and*
- (c) *The current state of technical knowledge and the likelihood that the option can be successfully applied."*

The Councils' minimum expectations for ALL land disturbing activities are:

For land disturbance activities requiring resource consent and for permitted activities, consistency with this guideline and use of best practice methods to ensure off site effects are avoided or minimised.

ALL sites, whether permitted or needing resource consent, should have considered the need for erosion and sediment controls and where appropriate develop an Erosion and Sediment Control Plan (refer to Chapter 7) that reflects the scale of the land disturbance and sensitivity of the receiving environments.

All land disturbing activities, whether permitted or requiring consent, will need to comply with the respective permitted discharge rules within the relevant Council Plan or apply for resource consents.

Compliance with any resource consents. To determine the requirements for consent for your project, it is prudent that you have discussions with Council staff in the first instance.

## 1.3 Industry Specific Guidelines

Some industries have erosion and sediment control guidelines specific to their activities which cover industry specific issues and best practice methods. These guidelines typically have the same end goals of minimising erosion and preventing the transport of sediments offsite or into waterways.

Industry specific guidelines can be used in conjunction with this guideline provided they are appropriate to Tasman and Nelson's soils and climate and employ best practice methods to the same or greater standard than identified in this guideline.

If you have any doubt as to which guidelines are appropriate for your activity, please contact Council to discuss.



## 1.4 Regulatory Context

The primary legal mandate for implementation of erosion and sediment control in New Zealand is the RMA.

Tasman District Council and Nelson City Council (NCC) have functions and powers under sections 30 and 31 of the Resource Management Act (RMA, 1991) to adopt plans and control activities and discharges for the purposes of soil conservation, controlling the effects of land use and development and maintaining and enhancing water quality and ecosystems. The councils' have prepared the Tasman Resource Management Plan (TRMP) and the Nelson Resource Management Plan (NRMP) to carry out these functions and duties.

The Councils are also required, as building consent authorities, to enforce the Building Act 2004, along with the New Zealand Building Code. The Building Code (B1 and E1) requires site works (including earthworks), buildings and surface water to be managed to avoid damage or nuisance to people, other properties (including roads) and outfalls (including natural waterways, kerb and channel or soakage systems).

Builders are also referred to the Small Sites Erosion and Sediment Control brochure July 2019 for advice on erosion and sediment control methods suitable for use on small building sites.

## 1.5 Tasman Resource Management Plan (TRMP)

The TRMP identifies key issues in the Tasman District and provides means of implementing controls through objectives, policies and rules which specify the need for resource consent and conditions for permitted activities. The land disturbance rules form the basis of erosion and sediment control planning in the Tasman area.

The policies and rules in the TRMP should be read by those intending on any activity that disturbs ground cover or soil to identify the status of a particular project for consenting requirements or permitted activity conditions.

It is important to note that regardless of whether an activity is permitted or requires resource consent, anyone undertaking land disturbance activities, of any scale, should consider erosion and sediment control requirements and develop an appropriate plan to minimise adverse effects from erosion and sediment transportation (refer to Chapter 7 for further information on Erosion and Sediment Control Plans).

Situations which require specific consideration of erosion and sediment management include (but are not limited to):

- Land Disturbance Areas
- Slope Instability Risk Areas
- Quarry areas
- Contaminated soils
- Landscape priority or significant natural areas, including native vegetation
- Water Conservation Order areas
- Within 20m of a water body (river, stream, lake or wetland)
- Within 20m of any stop bank
- Within 200m of the coastal marine area (the Coastal Environment Area)
- Within 32m of electricity transmission lines
- Within a flood hazard area or within a flood plain
- Within or areas including a known cultural site.

The sections of the TRMP of particular relevance to erosion and sediment control are highlighted in red in Table 1-2 and key aspects are outlined in the following sections.

### 1.5.1 TRMP Policies and Objectives

Generally, the TRMP policies and objectives seek to ensure:

- Development only occurs where adequate provision is made for control of sediment discharges.
- Developers adopt appropriate management methods to avoid or mitigate the adverse effects of stormwater run-off.
- The avoidance, remedying or mitigation of adverse effects of land disturbance, including:
  - Damage to soil
  - Acceleration of the loss of soil
  - Sediment contamination of water and deposition of debris into rivers, streams, lakes, wetlands, karst systems and the coast
  - Damage to riverbeds, karst features, land, fisheries or wildlife habitats, or structures through deposition, erosion or inundation
  - Adverse visual effects
  - Damage or destruction of indigenous animal, plant, and trout and salmon habitats, including cave habitats, or of sites or areas of cultural heritage significance
  - Adverse effects on indigenous biodiversity or other intrinsic values of ecosystems.
- The promotion of land use practices that avoid, remedy or mitigate the adverse effects of land disturbance on the environment.
- Land disturbance activities are managed consistent with their risks on different terrains in the District, including consideration of:
  - Natural erosion risk, and erosion risk upon disturbance
  - Scale, type, and likelihood of land disturbance
  - Sensitivity and significance of water bodies and other natural features in relation to sedimentation or movement of debris
  - Coastal risk areas
  - Climate related risks.

### 1.5.2 TRMP Rules – under review

**Chapter 18.5 - Land Disturbance Areas** provides the rules for Land Disturbance including earthworks, soil disturbance and vegetation removal or destruction (covering also quarrying, cultivation, trenching, firebreaks, roads, tracks, etc). Rules regulate activities according to whether they are in:

- Land Disturbance Area 1 (all dry land, except land in Land Disturbance Area 2) or
- Land disturbance Area 2 (Separation Point Granite geology)

**Chapter 18.6 (Quarry Area)** and **Chapter 18.12 (Slope Instability Risk Area)** provide further rules for land disturbance in these respective areas (refer to the TRMP maps for where these areas are located).

**Chapter 28 (Rules for Activities in the Beds and on the Surface of Rivers and Lakes)** and **Chapter 30 (Rules for Taking, Using, Damming and Diverting Water)** provide rules of particular relevance to activities undertaken in and around waterbodies, including damming or diversion of water to enable works, vehicle and stock access across waterways and installation of culverts, bridges and utility services, etc (refer section 11 for further information on activities within and around watercourses).

**Chapter 36 (Rules for Contaminant Discharges)** contains rules regulating discharges of sediment, debris, vegetation and other contaminants to land, water and coastal areas. The chapter also covers discharges of dust and stormwater.

**Part V – Annex 1 and 2** contain the Water Conservation Orders for Buller River (2001) and Motueka River (2004) respectively. These specify water quality standards within these two waterways (refer Section 4.4.9 for further information).

**Table 1-1 Tasman Resource Management Plan - Document Structure**

<b>Part 1 - Introductory</b>	Contextual Chapters	Chapter 1 - Introduction
		Chapter 2 - Meaning of Words
		Chapter 3 - Local authorities cross boundary issues
		Chapter 4 - Monitoring and review procedures
<b>Part 2 - Land</b>	District wide Objectives and Policies	Chapter 5 - Site Amenity effects
		Chapter 6 - Urban environment effects
		Chapter 7 - Rural environment effects
		Chapter 8 - Margins of river lakes, wetlands and coast
		Chapter 9 - Landscape
		Chapter 10 - Significant natural values and historic heritage
		Chapter 11 - Land transport effects
		Chapter 12 - Land disturbance
		Chapter 13 - Natural hazards
		Chapter 14 - Reserves and open space
	Chapter 15 - Infrastructure and network utilities	
	Rules	Chapter 16 - General rules
		Chapter 17 - Zone rules
		Chapter 18 - special area (Includes Land Disturbance, Slope instability rules)
	Other	Chapter 19 information required with Land use consent or Subdivision consent applications
	Appendices	App 1 Designations, App. 2 - Urban Design Guide, App. 3 - Coastal Tasman Area Subdivision and Development Design Guide
<b>Part 3 - Coastal Marine Area</b>	District wide Objectives and Policies	Chapter 20 - Effects of craft using surface of coastal water
		Chapter 21 - Effects of Disturbance, structures and occupation on coastal marine conservation and heritage, access and amenity values
		Chapter 22 - Aquaculture
		Chapter 23 - Natural Hazards and Hazardous substances
	Chapter 24 - Noise emissions	
	Rules	Chapter 25 - Coastal marine area rules
Other	Chapter 26 information required with Coastal Permit Applications	
<b>Part 4 - Rivers and lakes</b>	District wide Objectives and Policies	Chapter 27 - Activities in the beds and on the surface of rivers and lakes
	Rules	Chapter 28 – Rules for activities in the beds and on the surface of rivers and lakes
	Other	Chapter 29 information required with Land use activities

<b>Part 5 - Water</b>	District wide Objectives and Policies	Chapter 30 - Taking, using, damming and diverting water
	Rules	Chapter 31 - Rules for water take, diversion, use or damming
	Other	Chapter 32 information required with permitted applications for taking, using, damming or diverting water Annex 1 and 2 Water Conservation Orders – Motueka and Buller Rivers
<b>Part 6 - Discharges</b>	District wide Objectives and Policies	Chapter 33 - Discharges to land and fresh water
		Chapter 34 - Discharges to air
		Chapter 35 - Discharge to Coastal marine area
	Rules	Chapter 36 - Rules for contaminant discharges
Other	Chapter 37 information required with Discharge Permit Applications Annex 1 Marine pollution regulations, Annex 2 NES Air pollutants	

## 1.6 Nelson Resource Management Plan (NRMP)

The NRMP identifies key issues in the Nelson City Council area and provides means of implementing controls through objectives, policies and rules which specify the need for resource consent and conditions for permitted activities. The vegetation clearance, soil disturbance and earthworks rules form the basis of erosion and sediment control planning in Nelson.

The objectives, policies and rules in the NRMP should be read by those intending on any activity that disturbs ground cover or soil to identify the status of a particular project for consenting requirements or permitted activity conditions.

It is important to note that regardless of whether an activity is permitted or requires resource consent, anyone undertaking land disturbance activities (vegetation clearance, soil disturbance and earthworks), of any scale, should consider erosion and sediment control requirements and develop an appropriate plan to ensure there are no adverse effects from erosion and sediment transportation (refer Chapter 7 for further information on Erosion and Sediment Control Plans).

Situations which require specific consideration of erosion and sediment management include (but are not limited to):

- Areas identified on the Planning Maps as Land Management Overlay
- Areas identified on the Planning Maps as Slope Risk Overlay
- Land with a predominant slope exceeding 25 degrees
- Contaminated soils
- Areas identified as Landscape Overlay
- Areas identified as Conservation Overlay
- Areas identified as Coastal Environment Overlay
- Conservation Zone land
- Within 5m of a river identified with a Riparian Overlay (or coast)
- Within 20m of the Coastal Marine Area
- Areas identified as Flood Hazard Overlay, Flood Path, or an Inundation Overlay.

The sections of the NRMP of particular relevance to erosion and sediment controls are highlighted in red in Table 1-2 and key aspects are outlined in the following sections.

### 1.6.1 NRMP Policies and Objectives

Generally, the NRMP policies and objectives seek to ensure:

- Adverse effects of soil erosion, particularly sedimentation, are avoided, remedied or mitigated.
- Identify areas where accelerated soil erosion or sedimentation associated with the existing land uses or management practices exceed the sustainable capabilities of the land and promote alternative sustainable land uses or management practices.
- Land use management practices should minimise the contribution of diffuse (or “non-point”) source contaminants to water in the coastal environment.
- Protection of riparian (stream) margins and coastal margins, and their natural functioning, from activities to protect stream and esplanade values.
- Maintain water quality by requiring use of techniques to limit both nonpoint discharges and control point source stormwater discharges caused by land disturbing activities such as forestry, subdivisions and land development, increased impervious surfaces, and commercial and industrial activities.
- Control land use activities which have potential to adversely affect surface water quality and to encourage land use activities that minimise and filter contaminants entering water bodies.
- Minimising to the greatest practicable extent discharges of contaminants in stormwater to the Coastal Marine Area.
- Activities should not aggravate known or potential natural hazards, on their own site or another site.
- Contaminated sites should be managed to contain effects, and to promote the rehabilitation of sites.

### 1.6.2 NRMP Rules

The key NRMP rules relating to erosion and sediment control are:

#### 1.6.2.1 Vegetation Clearance, Soil Disturbance and Earthworks

These three rules appear in each zone of the plan. In each instance the rules set out which of the activities can occur as a permitted activity subject to conditions, or where resource consent as a controlled activity or a discretionary activity.

#### 1.6.2.2 Riparian Overlay, Land Management Overlay, Slope Risk Overlays, Landscape Overlay, Conservation Overlay, Inundation Overlay, and Coastal Environment Overlay (Rural Zone)

These are particular rules that apply in each zone if the particular environmental factor has been identified on the planning maps in that zone. Where these overlays are present, particular controls may apply to earthworks or vegetation clearance.

## 1.7 Subdivision

Each zone contains a rule for subdivision and provide for the council to exercise control in granting a subdivision consent over vegetation clearance, land disturbance and earthworks, including as they affect soil erosion and sedimentation.

**Table 1-2 Nelson Resource Management Plan – Document Structure**

<b>Volume 1</b>	Contextual Chapters & District wide Objectives and Policies	Chapter 1 - Introduction
		Chapter 2 – Meaning of Words
		Chapter 3 – Administration (including information required with consent applications)
		Chapter 4 – Resource Management Issues
		Chapter 5 – District Wide Objectives and Issues (including DO 13 Soil erosion and sedimentation)
		Chapter 6 - Financial Contributions
<b>Volume 2</b>	Zone specific Objectives, Policies and Rule	Chapter 7 – Residential Zone
		Chapter 8 – Inner City Zone
		Chapter 9 Suburban Commercial Zone
		Chapter 10 – Industrial Zone
		Chapter 11 – Open Space & Recreation Zone
		Chapter 12 – Rural Zone
		Chapter 13 – Coastal Marine Area
		Chapter 14 – Conservation Zone
<b>Volume 3</b>	Appendices	Appendix 28 – Freshwater (water quality standards and rules)

\*Volume 4 of the NRMP contains the Planning Maps, which include Land Management Overlay in places, defining land is especially sensitive to activities that cause erosion and sedimentation.

**If you are unsure which rules apply to your site or activity contact the relevant Council to discuss.**

## 1.8 Nelson Tasman Land Development Manual (NTLDM)

The Nelson Tasman Land Development Manual (NTLDM) identifies the standards and specifications for infrastructure assets in the Nelson/Tasman region. The document covers development including creation of public assets, such as water supply, wastewater, stormwater, roading and reserves, as well as electrical and telecommunications utilities.

# Chapter 2

## Te Ao Māori Values

NELSON TASMAN  
**EROSION AND SEDIMENT  
CONTROL GUIDELINES**

JULY 2019





DRAFT FOR DISCUSSION

DRAFT FOR DISCUSSION

## TABLE OF CONTENTS

2	TE AO MĀORI VALUES.....	1
2.1	Preamble.....	1

DRAFT FOR DISCUSSION

## 2 TE AO MĀORI VALUES

Placeholder

### 2.1 Preamble

This section is intentionally blank to allow for a section to be completed for Te Ao Māori values. This work is yet to be completed.

DRAFT FOR DISCUSSION

# Chapter 3

## Land Disturbance Issues

NELSON TASMAN  
**EROSION AND SEDIMENT  
CONTROL GUIDELINES**

JULY 2019





## TABLE OF CONTENTS

<b>3</b>	<b>LAND DISTURBANCE ISSUES</b> .....	<b>1</b>
<b>3.1</b>	<b>Introduction</b> .....	<b>1</b>
<b>3.2</b>	<b>Erosion and Sediment Processes</b> .....	<b>2</b>
3.2.1	Erosion.....	2
3.2.2	Sediment Control .....	2
3.2.3	Rainfall.....	3
3.2.4	Soils and Geology .....	5
3.2.5	Slopes .....	6
3.2.6	Size of disturbance .....	6
<b>3.3</b>	<b>Vulnerable Geology and Soils in Tasman District</b> .....	<b>7</b>
3.3.1	Moutere Gravels .....	7
3.3.2	Separation Point Granites .....	8
3.3.3	Karst Landscapes .....	8
<b>3.4</b>	<b>Vulnerable Geology and Soils in Nelson District</b> .....	<b>10</b>
3.4.1	Land Management Overlay .....	10
3.4.2	Slope Risk Overlays .....	10
<b>3.5</b>	<b>Types of Erosion</b> .....	<b>12</b>
3.5.1	Splash Erosion .....	12
3.5.2	Sheet Erosion .....	12
3.5.3	Rill Erosion.....	12
3.5.4	Gully Erosion .....	13
3.5.5	Tunnel Erosion .....	13
3.5.6	Channel Erosion .....	13
<b>3.6</b>	<b>Mass Movement</b> .....	<b>14</b>
3.6.1	Wind Erosion .....	14
3.6.2	Other existing soil contaminants.....	15
<b>3.7</b>	<b>Nutrients</b> .....	<b>16</b>
<b>3.8</b>	<b>Polycyclic Aromatic Hydrocarbons</b> .....	<b>16</b>
<b>3.9</b>	<b>Metals</b> .....	<b>16</b>
<b>3.10</b>	<b>Non-sediment contaminants</b> .....	<b>16</b>
3.10.1	Construction Materials.....	16
<b>3.11</b>	<b>Sediment Transport Pathways</b> .....	<b>17</b>

## LIST OF TABLES

Table 3-1	Annual soil loss in Auckland .....	1
Table 3-2	Roughness Coefficients for Various Surface Covers and Travel Times.....	7



## LIST OF FIGURES

Figure 3-1	Raindrop hitting the ground .....	2
Figure 3-3	Locations of Vulnerable Geologies in Tasman.....	9
Figure 3-5	Nelson City Vulnerable Geologies.....	11
Figure 3-6	Schematic of Raindrop Splash .....	12
Figure 3-7	Sheet Erosion into an Estuary.....	12
Figure 3-8	Rill Erosion on a Highway Embankment .....	12
Figure 3-9	Gully Erosion - photo courtesy of BOPRC and Ridley Dunphy Environmental Limited .....	13
Figure 3-10	Tunnel erosion.....	13
Figure 3-11	Channel Erosion .....	13
Figure 3-12	Mass Slumping in McConnon Creek Catchment .....	14
Figure 3-13	Wind Erosion on Ruby Bay Bypass.....	14
Figure 3-14	Schematic of Types of Wind Erosion .....	14
Figure 3-15	Source, Pathway and Receiving Environment .....	17

### 3 LAND DISTURBANCE ISSUES

#### 3.1 Introduction

Erosion and sedimentation are natural processes which can be accelerated and exacerbated by development, construction, vegetation removal and other land disturbing activities and land uses. Studies have identified sediment yield increases from bare soil during storms of 32 times that of pastoral land and 100 times that of undisturbed or stable areas (Senior, 2003; Hicks, 1994).

Sediment yields can vary greatly depending on site characteristics (Moores, Pattinson, 2008; Larcombe, 2009) and land uses. In particular, one of the greatest impacts of urbanisation on receiving waters can come from soils eroded during urban construction (Williamson, 1993). This erosion can have an enormous impact immediately downstream of new earthworks. Discharged sediment can greatly alter the stream channel morphology and smother aquatic life. Water draining from these catchments can remain very turbid even during low flows.

Table 2 indicated the levels of soil loss that can occur from storm events, the results are for the Auckland region, but similar outcomes could be anticipated in the Nelson Tasman region.

Table 3-1 Annual soil loss in Auckland

#### ANNUAL SOIL LOSS IN AUCKLAND REGION\*

Land-Use	Measured (Tonnes/km <sup>2</sup> /year)	Predicted Average Annual Soil Loss (Predicted over 20 year period) (Tonnes/km <sup>2</sup> /year)
Pasture	49	46
Market Gardening	49	52
Developed Urban – Industrial	107	100
Developed Urban – Residential	24	24
Earthworks	6,600	16,800

\* **Reference:** “Storm Sediment Yields from Basins with Various Land Uses in Auckland Area” – National Institute of Water and Atmospheric Research (July 1994).

The impacts of erosion and sedimentation have been investigated in many countries, over many decades and such impacts have been well studied in New Zealand. There can be economic impacts associated with increased deposition of sediments downstream. Sediments can clog culverts and fill in drainage channels, storm drain systems, estuaries, wetlands, harbours and marina areas. Significant public expenditure is required to maintain these areas. Sedimentation can also damage important fisheries such as Tasman Bay scallops and affect recreational enjoyment of receiving environments (eg swimming and fishing). In addition to economic impacts, there are environmental impacts related to reduction in light penetration due to elevated turbidity and smothering of bottom dwelling aquatic organisms by sediment deposition. These environmental impacts can have wide ranging implications for other species and future generations.

## 3.2 Erosion and Sediment Processes

There is a direct relationship between erosion and sediment control. Simplistically, erosion is detachment of soil particles from the ground's surface by wind or water. The detached particles become sediment once entrained by water (rainfall or overland flow) or dust when entrained by wind.

**Erosion** is the process whereby the land surface is worn away through physical, chemical or biological processes resulting in detachment and transport of soil particles.

**Sediment** is made up of detached soil particles.

**Sediment yield** is the amount of sediment discharged from a catchment reaching or passing a point of interest in a given period of time. Sediment yield estimates are normally given as tonnes per year or kilograms per year.

**Erosion control** is stopping the soil particles being detached.

**Sediment control** is stopping the deposition of eroded soils to an inappropriate receiving environment such as adjacent properties, unique habitats, streams, lakes and Coastal Management area where sediment can cause environmental harm to both habitat and ecology values.

### 3.2.1 Erosion

Erosion is a natural process and even land covered by native vegetation has erosion including landslides, slips, etc. However, land disturbing activities, including vegetation removal, dramatically increases erosion rates. Natural erosion is generally considered in geological terms (hundreds of years), whilst accelerated erosion from our activities is considered frequently from an annual basis.

Soil erosion is initiated by the impact of raindrops hitting the ground and preventing that erosion is a key element in an overall erosion and sediment control strategy.

The primary means of limiting this erosion is to provide either permanent or temporary vegetative or synthetic cover to dissipate the raindrop impact and reduce soil erosion potential.

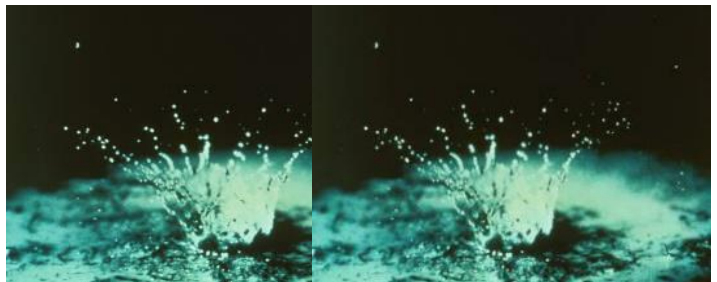

Figure 3-1 Raindrop hitting the ground

Other types of erosion are discussed in section 3.4 and relate to situations once raindrops have hit the ground. They relate to stormwater flow concentration and the impacts that has on sediment production.

Erosion control is the key first step in reducing site erosion and reducing the amount of work that sediment control practices have to do. This is especially true of land disturbing activities in Separation Point Granites (refer section 3.3.2), which are highly erodible due to their lack of cohesion. Erosion control is also an important element in reducing potential erosion due to high winds.

### 3.2.2 Sediment Control

Sediment control involves the implementation of practices that, in general, promote deposition or sedimentation, in order to prevent sediment leaving the site where they were generated. A basic premise of most sediment control practices is that they slow the flow of water until the sediments, through gravity, fall to the bottom of the water column, where they settle.

If sediment is not captured on-site by sediment control practices, sediment loadings to receiving systems are increased and economic and environmental effects could occur.

There are factors that dictate the potential sediment yield from a site and therefore determine how your site should be managed including the specific selection and design of erosion and sediment control measures.

These factors include:

- Rainfall
- Soils and geology
- Slope length and angle
- Size of disturbance
- Management practice installed.

### 3.2.2.1 Universal Soil Loss Equation (ULSE) - as a means of estimated sediment yield

The USLE is a simple model originally developed for agricultural practices in the USA. It is a suitable sediment yield estimation tool for activities such as earth working operations.

Rather than providing an accurate estimate of actual total sediment yield the most beneficial use of the USLE is to help identify variations of potential sediment yields across a particular site. It is critical that a site is divided up into logical sectors based on gradient, slope length and surface cover. Other factors are the proximity and nature of the receiving environment. Once completed the USLE will then allow the erosion and sediment control methodology to be tailored to suit the site's variations.

While the overall estimate of yield is indicative of the magnitude of sediment likely to be discharged, the range of assumptions required in the USLE calculation means that it should not be relied on as an accurate assessment of actual total yield.

The USLE is represented by the following equation.

$$A = R * K * (LS) * C * P$$

Where:

A	=	soil loss (tonnes/hectare/year)
R	=	rainfall erosion index (J/hectare)
K	=	soil erodibility factor (tonnes/unit of R)
LS	=	slope length and steepness factor (dimensionless)
C	=	vegetation cover factor (dimensionless)
P	=	erosion control practice factor (dimensionless)

Further information on determining the input factors and using the USLE is provided in Appendix 13.6.

The USLE can be used in a number of ways when developing erosion and sediment control plans:

- To calculate the total estimated sediment yield for a site.
- To identify the sub-catchment areas of a site at greatest risk of sediment generation allowing targeted location of erosion and sediment controls.
- To identify suitable controls and design specifications that will be able to cope with the estimated sediment yields.
- To assess the proposed erosion and sediment controls by comparing calculations – with and without the controls included or with alternative control approaches.

### 3.2.3 Rainfall

Important aspects of rainfall to consider are the intensity, duration and frequency. Frequent rainfall can result in ground wetness which makes soils more prone to erosion forces. High intensity and long duration rainfall can result in significant levels of erosion, initially from rain drop impact and then from overland flow causing rill, gully and channel erosion.



The Nelson / Tasman District has highly variable rainfall. Annual rainfall can range from approximately 1000 mm/year in the east up to 5 - 500 mm/year in western areas. Rain falls on average between 100 and 150 days per year with higher elevations having up to 200 rain days per year. The highest intensity rainfall events over a short duration (<1 hr) are more likely to occur in summer due to convectional activity but they can occur at any time in any place.

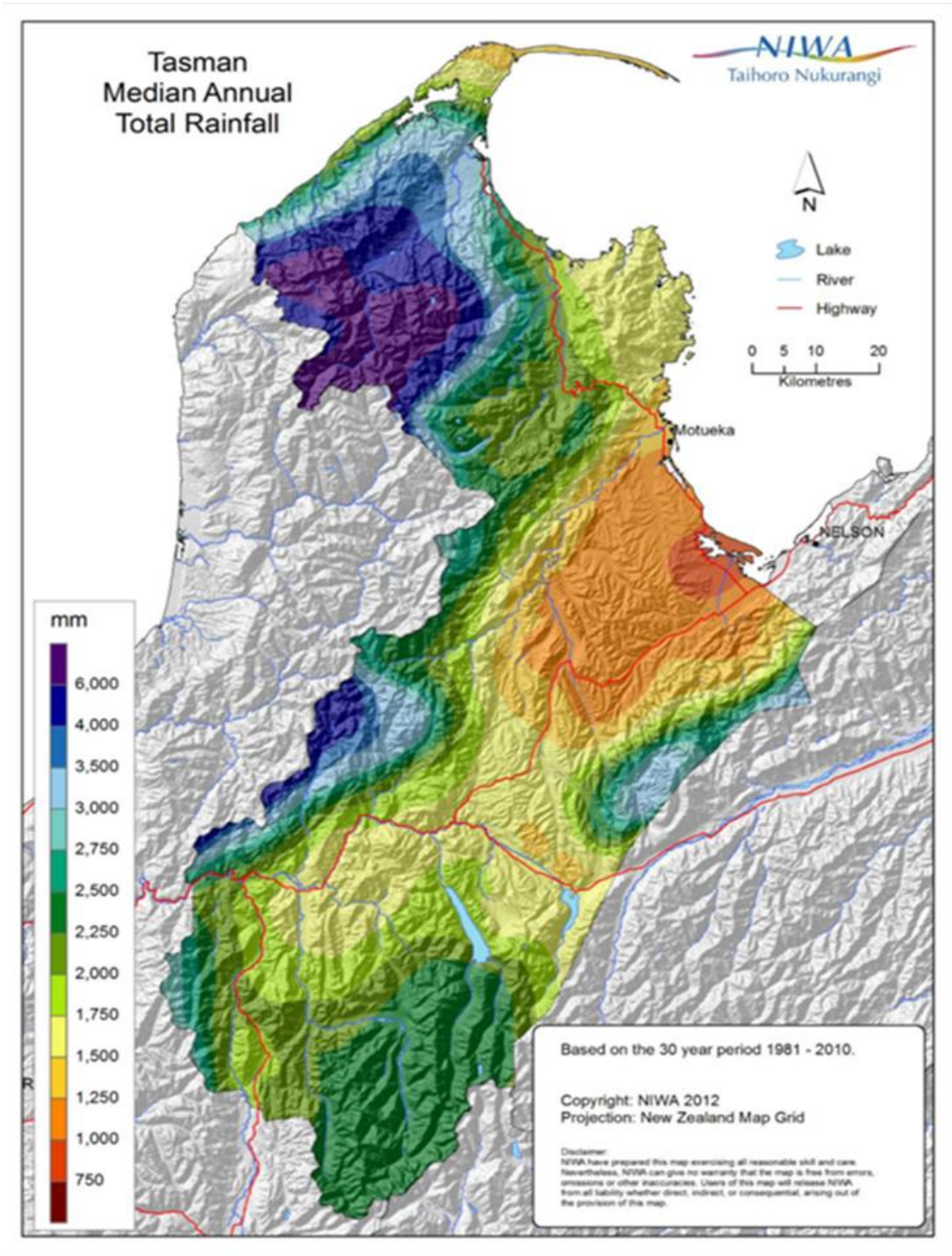

Figure 3 2 NIWA Total Median Annual Rainfall in the Tasman District

### 3.2.4 Soils and Geology

Many characteristics of soils, including texture, acidity, moisture retention, drainage and slope have an influence on the soils' vulnerability to erosion. The following soil characteristics have primary importance in determining soil erodibility:

- Texture
- Organic matter content
- Structure, and
- Porosity.

#### 3.2.4.1 Soil texture

Soil texture relates to the sizes and proportions of the particles making up a soil. Sand, silt and clay are the three major classes of soil particles. Sand has a coarse texture while silts and clays are fine textured. Soil texture relates to erodibility as sands have a higher infiltration potential and reduce the volume of surface runoff and thus have less erosion. Clays are bound tightly together and resist erosion, but once erosion starts it is difficult to trap these finer soils.

#### 3.2.4.2 Organic matter content

Organic matter is primarily plant and animal litter in various stages of decomposition. Organic matter improves soil structure and increases permeability, water retention capacity and soil fertility. Organic matter, which is primarily found in topsoil, reduces runoff and erosion potential.

#### 3.2.4.3 Structure

Soil structure includes the arrangement of particles into aggregates (groups of particles) and the size, shape and distribution of pores both within and between the aggregate.

There are a number of factors that influence soil structure (Rowell, 1994). These factors include the following:

- Physical processes:
  - Drying and wetting which cause shrinkage and swelling with the development of cracks and channels.
  - Freezing and thawing which create spaces as ice is formed.
- Biological processes:
  - The action of plant roots, which remove water resulting in the formation of spaces by shrinkage, release organic materials, and leave behind organic residues and root channels when they die.
  - The action of soil animals which move material, create burrows and bring mineral and organic residues into close association.
  - The action of micro-organisms which break down plant and animal residues, leaving humus as an important material which binds particles together.

The formation of soil structure thus requires both physical rearrangement of particles and the stabilisation of the new arrangement. Stability is particularly associated with organic materials linking mineral particles together and with clay minerals and sesquioxides (eg  $Al_2O_3$ ).

Over a period of time loose, freshly cultivated soils consolidate. Consolidation is natural settling due to the force of gravity. A soil under vegetation does not consolidate as its structural stability enables it to withstand natural forces.

#### 3.2.4.4 Porosity

Soil porosity is of vital importance in the ability of soils to support plant, animal and microbial life. The spaces hold water, allow for drainage, allow entry of oxygen and removal of CO<sub>2</sub> from the soil, allow for root penetration into the soil and are indirectly responsible for modifying the mechanical properties of soils.

Soil porosity depends on the structure of the soil. It varies depending on:

- Texture and organic matter content
- Depth in the soil profile
- Management, as this causes changes in organic matter content over time and applies forces to soils which may either loosen or compact them.

Compaction causes a reduction in porosity due to external forces being applied to the soil. The most common examples of compaction are vehicle movement on the soil or under the feet of animals. These restrict the passage of water into and through the soil increasing runoff potential and soil erosion.

Organic matter and the associated biological activity in soils are of major importance in maintaining soil porosity.

#### 3.2.5 Slopes

##### Key fact:

The erosion of soil from a slope increases as the slope increases and lengthens - **the erosion rate triples as slope doubles** (Senior, et.al, 2003) and erosion rate is 1.5 times when slope length doubles.

Steep slopes contribute a disproportionate level of sediment for the same sized disturbed area on less steep slopes.

Slope length and steepness are critical factors in erosion potential, since they determine to a large extent the velocity of surface runoff. The energy and erosion potential of flowing water increases as the square of the velocity increases.

#### 3.2.6 Size of disturbance

Greater areas of site disturbance increase erosion potential and sediment yield.

At low levels of site disturbance (4-10% of total site area), median sediment loadings are predicted to increase approximately 4-fold over existing land use sediment loadings. However, for maximum disturbance by earthworks (100%) the predicted increases in median loads range from about 40 to over 80-fold (NIWA, 1997).

Removal of vegetative cover, including vegetation and topsoil, increases surface runoff and erosion potential. Vegetation enhances evapo-transpiration, which tends to dry soils out between storm events. Vegetation also has a roughness associated with it which impacts on flow velocities across it.

Table 3-2 (ARC, 2000) shows the increased time that water takes to travel across various surfaces. Longer travel times reduce the potential for erosion of land surfaces.



Table 3-2 Roughness Coefficients for Various Surface Covers and Travel Times

Surface	Roughness Coefficient (unit less)	Travel Time (hours) <sup>1</sup>
Bare soil	0.011	0.014
Pasture	0.13	0.093
Grass (short)	0.15	0.109
Grass (taller)	0.24	0.159
Bush (light understory)	0.40	0.24
Bush (dense understory)	0.80	0.447
1 Assumed 50m length, 12% slope, and 83 mm of rainfall		

### 3.3 Vulnerable Geology and Soils in Tasman District

Tasman District has a high diversity of geology and soils. While consideration of site geology and soils should be undertaken for all sites, three geologies in particular have been identified as causing specific concern in managing erosion and sediment control.

These are:

- Moutere Gravels (Moutere Clays)
- Separation Point Granites
- Karst Landscapes.

The extent of these geologies is shown in Figure 3-3. Sites within these areas - and in the case of Karst Landscapes, sites draining to this area – need to consider the specific erosion potential and sediment transport characteristics of these geologies and select appropriate site management methods and control practices.

#### 3.3.1 Moutere Gravels

Moutere Gravels (often also referred to as Moutere Clays) are clay-bound gravels capped by strongly weathered and leached soils. The soils are characterised by shallow loamy topsoil that is easily eroded when bare of vegetation. The subsoils are deep clay bound gravels. Whilst they are generally stable disturbed sites can be a significant source of clay particles. Erosion potential is moderate, increasing in severity on steeper slopes.

They cover about 750,000 ha and tend to be located in gently to strongly rolling downs and hill country and they can be found on steep coastal cliffs

Earthworks in Moutere Gravels are to be carefully considered with erosion and sediment control practices used as integral components of the earthworks. Due to the very fine clay particles present in these soils, once eroded the clays are very difficult to trap and therefore flocculation is often required to achieve adequate controls of suspended sediment loads (refer Chapter 9, Section 5). Sites with Moutere Gravels should have the soils subject to a chemical treatment bench test to determine the need for and benefits of flocculation. A focus on minimising erosion when working on these soils will help reduce the need for sediment control.

### 3.3.2 Separation Point Granites

The Separation Point Granites are a strip of granitic bedrock in the order of 10 kilometres wide that extends for over 100 kilometres from Abel Tasman National Park in the north to Mt Murchison in the south as shown in Figure 3-3. It is sand derived from these rocks that form the golden beaches of Abel Tasman National Park.

At the land surface this rock is deeply weathered. This weathered surface can be up to several metres in depth and is extremely erodible and readily breaks down to its constituent components forming coarse sand. Because of the highly erodible nature of the Separation Point Granites particular care is needed when undertaking any form of land disturbance. It is also important that erosion and sediment controls used in these areas are designed to cope with high intensity storms and maintained so as to remain effective until the site is adequately stabilised.

There are several key points to be considered when undertaking land disturbance in separation point granites:

- Keep disturbed areas small through site staging
- Implement site perimeter controls even in very small disturbed areas
- Site earthworks should avoid concentrating stormwater flows
- Stabilise disturbed areas immediately upon completion of earthworks
- Stage site works to allow for progressive stabilisation
- If site work ceases for more than seven days, temporary stabilisation should be provided.

The extent of the Separation Point Granite terrain is mapped as **Land Disturbance Area 2** in the Tasman Resource Management Plan planning maps. There are specific rules pertaining to land disturbance activities undertaken on this geology.

### 3.3.3 Karst Landscapes

Karst landscapes are primarily of concern due to their vulnerability to the effects of sedimentation as receiving environments. The impacts of soil erosion and sedimentation in karst landscapes can be severe. These impacts can also occur from works in other geologies that are located upstream or upslope of karst landscapes.

Karst landscapes are a consequence of the presence of soluble bedrock with soil ravelling (collapse into underground fissures and caves) primarily influenced by the intrusion of surface water.

These landscapes are present in parts of Golden Bay, along the Takaka Valley, Takaka Hill and the Arthur Range and south-west of Tapawera around Mt Owen (refer Figure 3-). Many of these areas are held within Department of Conservation land.

From an erosion and sediment control context there are three key issues:

1. The impact that water has on karst landscapes.
2. The impact that sediment entry could have on filling in natural caves, causing drainage changes and subsequent problems.
3. The adverse impact on downstream receiving systems, as contaminants can pass rapidly through the subsurface system with little or no change.

Activities in Karst landscapes (or upstream from karst landscapes) should identify and protect karst features, including streams, sinkholes, springs and cave entrances, from land disturbing and construction activities such as transport of sediment, construction materials, chemicals and equipment into these vulnerable systems. Changes that may alter drainage patterns and concentrate flows should be avoided and vegetation and a no-go buffer should be retained around any sinkhole or cave entrance. Sediment retention and stormwater ponds should only serve small areas and require impermeable liners. Site disturbance should be minimised as far as practicable.

Further information on karst landscapes and managing effects of land disturbance on them is available in section 3.3.

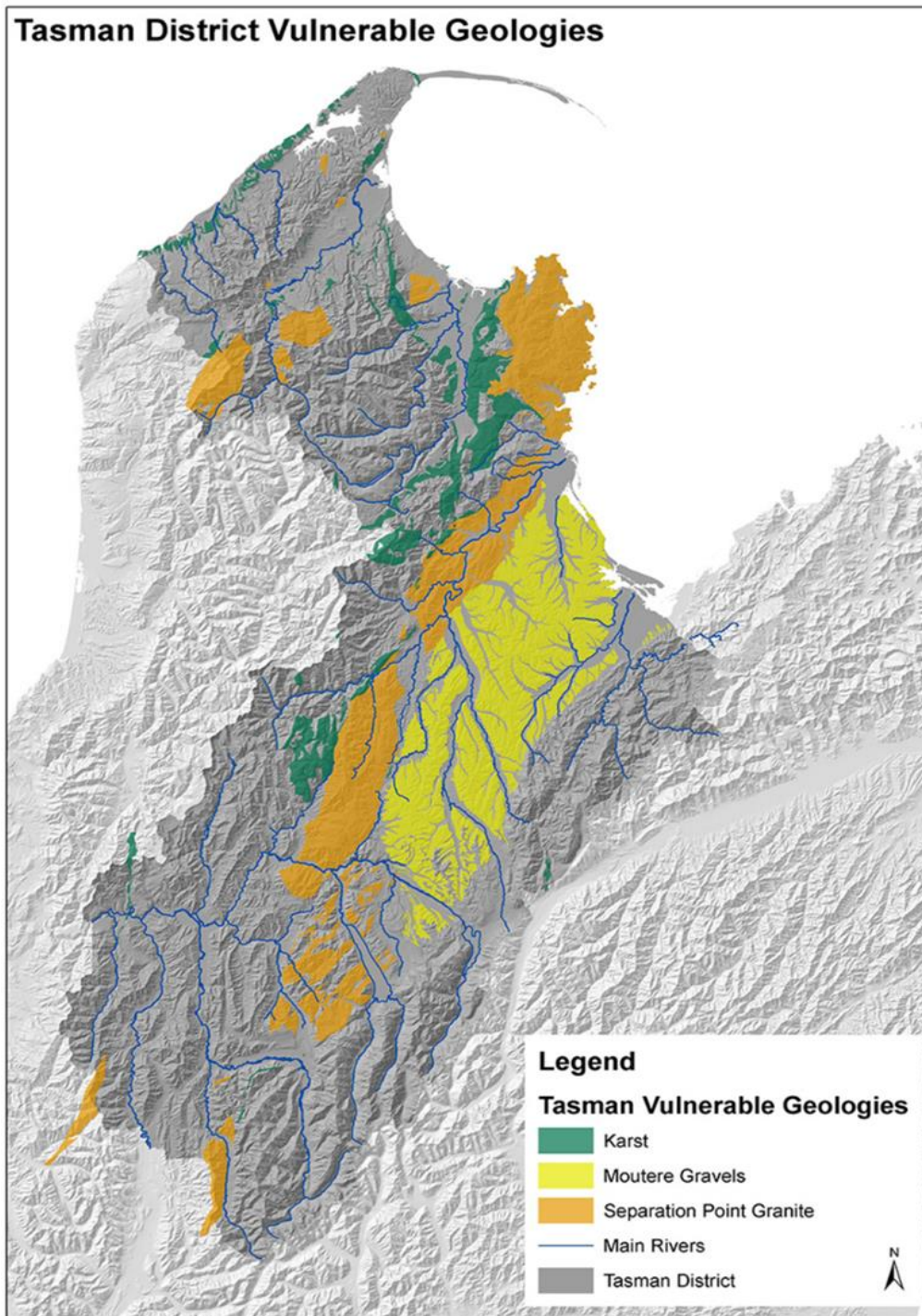

Figure 3-3 Locations of Vulnerable Geologies in Tasman

### 3.4 Vulnerable Geology and Soils in Nelson District

The Nelson City area is predominantly hilly with only relatively small areas of low-lying land in the valleys of the Maitai, Wakapuaka and Whangamoā rivers, at Stoke and at the head of Nelson Haven. By far the majority of the land area is classified as Class VIe or Class VIIe in the New Zealand Land Resources Inventory worksheets. These classifications describe the land as steep to very steep with erosion susceptibility and past erosion damage as major factors limiting potential land use. In other words, much of Nelson's land area is known to be naturally susceptible to soil erosion.

The NRMP planning maps identify areas of erosion or slope risk through the Land Management Overlay, and Slope Risk Overlays. These are shown in Figure 3-4 below.

#### 3.4.1 Land Management Overlay

The Land Management Overlay defines land that is especially sensitive to activities that cause erosion and sedimentation, particularly vegetation clearance, soil disturbance and earthworks. This tends to be those hill country areas with less stable underlying geology. Other hilly areas with more stable geology is not mapped but erosion and slope stability risk is managed by reference to the predominant slope of the land in the NRMP rules on vegetation clearance, soil disturbance and earthworks, with land with a slope angle of 6 degrees being lower risk, and 6 to 25 degrees low to moderate risk. The Land Management Overlay area is deemed high risk.

#### 3.4.2 Slope Risk Overlays

There are three slope risk overlays in the NRMP as shown on Figure 3-4. These are the Grampians Slope Risk Overlay, the Tahunanui Core Slope Risk Overlay and the Tahunanui Fringe Slope Risk Overlay. These overlays define two areas where there is a known or potential risk of slope movement or failure. These are differentiated from the Land Management Overlay as the predominant risk is landslide as opposed to erosion.

The Tahunanui Slump Core Risk Overlay comprises the Tahunanui Slump, an active landslide, which is slowly settling with sporadic bursts of more rapid movement. Because of the risk, developments including buildings and earthworks are controlled by the NRMP.

The Tahunanui Fringe Slope Risk Overlay is on the edge of the Core Risk Overlay. It includes the head and side scarps of the landslide along with ground marginal to the scapes, and where earthworks and drainage may impact on the Tahunanui Slump.

The Grampians Slope Risk Overlay extends from the vicinity of Seymour Avenue to Bishopdale and comprises an area underlain by generally weak rocks of the Late Cretaceous and Tertiary periods. There are pre-historic large rotational landslides on localised areas, but current slope movement is ill-defined. The overlay includes stable land whose stability could be threatened by inappropriate earthworks or drainage. All earthworks, other than minor garden landscaping involving cuts of not more than 0.6m in height and fill on any one site of not more than 3m<sup>3</sup>.



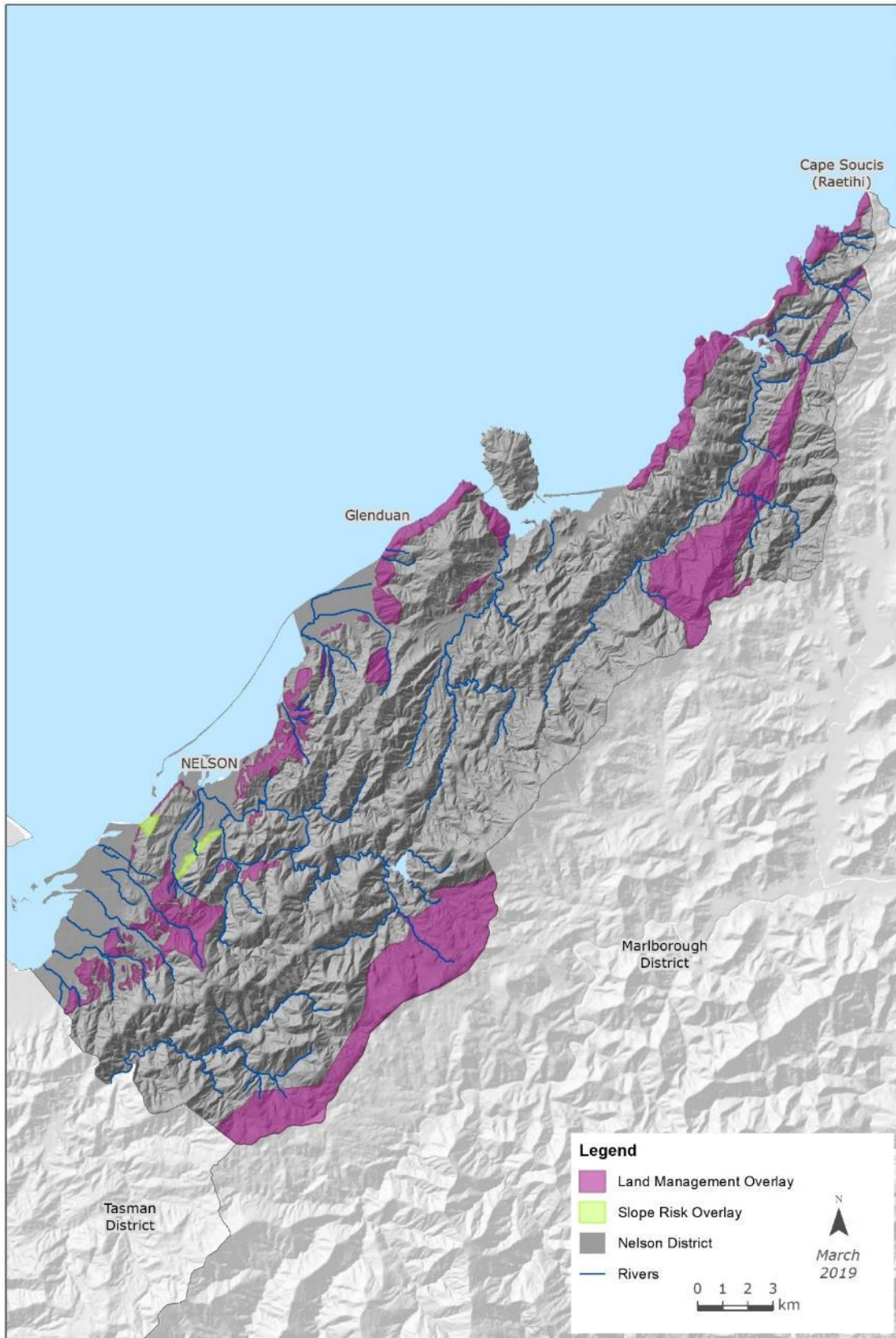

The map is an approximate representation only and must not be used to determine the location or size of items shown, or to identify legal boundaries. To the extent permitted by law, the Nelson City Council, their employees, agents and contractors will not be liable for any costs, damages or loss suffered as a result of the data or plan, and no warranty of any kind is given as to the accuracy or completeness of the information represented. Nelson City Council information is licensed under a Creative Commons Attribution 4.0 International License, and the use of any data or plan or any information downloaded must be in accordance with the terms of that licence. For more information please contact us. Cadastral information derived from Land Information New Zealand. CROWN COPYRIGHT RESERVED.

Figure 3-4 Nelson City Vulnerable Geologies

### 3.5 Types of Erosion

There are eight main types of erosion associated with land disturbing activities (ARC, 1999):

- |  |   |
|--|---|
| <ol style="list-style-type: none"> <li>1. Splash</li> <li>2. Sheet</li> <li>3. Rill</li> <li>4. Gully</li> </ol> | <ol style="list-style-type: none"> <li>5. Tunnel</li> <li>6. Channel</li> <li>7. Mass movement</li> <li>8. Wind.</li> </ol> |
|--|---|

#### 3.5.1 Splash Erosion

When ground vegetation is removed from an area being earth worked, the soil surface is exposed to raindrop impact.

Some of the splashed particles may rise as high as 0.6 m above the ground and move up to 1.5 m horizontally (Goldman, Jackson, Bursztynsky, 1986).

When raindrops hit bare ground, the soil aggregates are broken up and soil structure is destroyed.



Figure 3-5 Schematic of Raindrop Splash

#### 3.5.2 Sheet Erosion

Sheet erosion is caused by water sheeting across the soil surface. Sheet flow itself generally isn't the means of erosion but the flow conveys soil particles that have become detached through splash erosion.

When rainfall intensity exceeds the soils ability to absorb the rainfall overland flow is initiated. Initial runoff tends to be in the form of sheet flow, where the runoff is in a shallow dispersed flow where there is no concentration of flow. It can be a significant erosion process as it can cover large areas.

The shallow flow rarely moves more than a few metres before the onset of flow concentration due to surface irregularities.



Figure 3-6 Sheet Erosion into an Estuary

#### 3.5.3 Rill Erosion

Rill erosion is the transition area where sheet flow becomes concentrated flow. At this point, the velocity of flow increases and is accompanied by increased turbulence. The energy of water is increased as the flow depth increases, and this provides greater ability to detach and convey soil particles. Rills are small but well-defined channels that may be only 10-20 mm deep.



Figure 3-7 Rill Erosion on a Highway Embankment



### 3.5.4 Gully Erosion

Gully erosion is a complex process that is not fully understood. Some gullies are formed when runoff cuts rills deeper and wider or when the flows from several rills come together and form a larger channel. Gullies can erode in both uphill and downhill directions (Goldman, Jackson, Bursztynsky, 1986).

The following are the processes which act in the formation of gullies:

- Waterfall erosion at the head of a gully
- Channel erosion
- Raindrop splash
- Diffuse flow from the side of the gully or from seepage, and
- Slides or mass movement of soil within the gully.



Figure 3-8 Gully Erosion - photo courtesy of BOPRC and Ridley Dunphy Environmental

A gully may develop and grow rapidly, and their formation may generate a considerable amount of erosion.

### 3.5.5 Tunnel Erosion

An important way that tunnel erosion occurs in the Tasman District is in Karst (limestone) areas where water dissolves the limestone and creates underground flow paths.

Further discussion of Karst landscapes is provided in Section 3.3.3 and Chapter 4, section 3.

In other areas, runoff which flows directly into the subsoil via surface cracks, rabbit burrows, or old root holes may cause erosion. Once formed, tunnels continue to enlarge during subsequent wet periods. Eventually tunnels reach a point where the roof collapses resulting in sinkholes or the formation of gullies. Tunnels may range in size from a few centimetres to several metres in diameter.



Figure 3-9 Tunnel erosion

### 3.5.6 Channel Erosion

Channel erosion is a major source of sediment nationwide. The erosion of channels results from the conveyance of concentrated flows, whose velocities scour the channel boundaries. Channel erosion is a natural occurrence, but accelerated channel erosion is caused by a change in land use that increases the volume and rate of stormwater runoff.



Figure 3-10 Channel Erosion

### 3.6 Mass Movement

Mass movement is the erosion of soil or rock by gravity-induced collapse. It is usually triggered by groundwater pressure after heavy rain, but can also have other causes, such as stream bank undercutting or earthworks undercutting the base of a slope. Movement can be either rapid and near instantaneous or slow and intermittent. Earth and soil slip movement are also often noted after the removal of vegetation from critical slopes associated with earthworks (ARC, 1999).

Mass movement can cause major problems on earthworks sites and geotechnical investigations should be undertaken where possible to avoid critical slope failure.

#### 3.6.1 Wind Erosion

Strong winds can occur at various times of the year in Tasman. Most areas can also be subject to wind erosion during times of drought. Wind erosion effects can occur during horticultural planting times and on earthwork sites when areas have been cleared of vegetation and soil moisture deficits allow for transport.

There are three ways that soil moves due to wind:

1. Suspension
2. Creep or
3. Saltation.

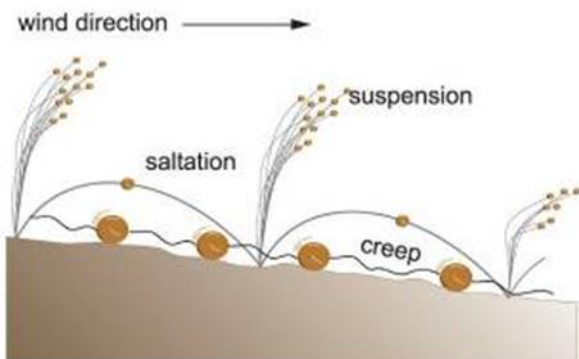

Figure 3-2 Schematic of Types of Wind Erosion



Figure 3-11 Mass Slumping in McConnon Creek Catchment



Figure 3-12 Wind Erosion on Ruby Bay Bypass



### 3.6.2 Other existing soil contaminants

In addition to contaminants from construction equipment and materials, land disturbance can mobilise existing contaminants already in the soils present on site.

Land previously used for horticulture can contain pesticides (eg DDT), fungicides and herbicides. Former orchards can contain copper sulphate, timber treatment sites can contain arsenic, chromium and copper, and sites with underground tanks can contain hydrocarbons.

The National Environmental Standard for Assessing and Managing Contaminants in Soil to Protect Human Health (NES-SC) identifies the permitted or consent status for activities on contaminated soil, including removing or replacing a fuel storage systems, sampling the soil, **disturbing the soil**, subdividing land, and changing the use of the piece of land. The NES-SC covers land where activities included on the Ministry for the Environment's Hazardous Activities and Industries List (HAIL) have been or are being undertaken (refer to the NES-SC for full wording).

The NES-SC also identifies the two methods by which a person (at their own cost) may establish whether or not a piece of land is covered by the NES-SC, namely:

- 1) "By using information that is the most up-to-date information about the area where the piece of land is located that the territorial authority:
  - a) holds on its dangerous goods files, property files, or resource consent database or relevant registers; or
  - b) has available to it from the regional council.
- 2) The other method is by relying on the report of a preliminary site investigation:
  - a) stating that an activity or industry described in the HAIL is, or is not, being undertaken on the piece of land; or
  - b) stating that an activity or industry described in the HAIL has, or has not, been undertaken on the piece of land; or
  - c) stating the likelihood of an activity or industry described in the HAIL being undertaken, or having been undertaken, on the piece of land.

A preliminary site investigation is defined in the regulations as an investigation that:

- (a) *is done by a suitably qualified and experienced practitioner; and*
- (b) *is reported on in accordance with the current edition of Contaminated Land Management Guidelines No. 1—Reporting on Contaminated Sites in New Zealand, Wellington, Ministry for the Environment; and*
- (c) *results in a report that is certified by the practitioner."*

A preliminary site investigation would initially be a desktop study that would include a site history, site visit and discussions with Tasman District Council and Nelson City Council. The results of this would determine the need for more intrusive site testing.

(Note: in Nelson and Tasman the Councils have both territorial and regional authority functions).

### 3.7 Nutrients

Nutrient discharges are closely related to sediment discharge levels as water discharging from construction sites carries both soil and nutrients that naturally occur in the soil. Soil nutrients can include the following elements that are necessary for normal plant growth: Potassium, Magnesium, Phosphorus, Calcium, Nitrogen and Sulphur. Generally, nitrogen has the greatest levels in soil.

Excess nutrients in receiving water bodies can cause algal blooms, lowering of water oxygen levels affecting aquatic life and creating nuisance odours.

### 3.8 Polycyclic Aromatic Hydrocarbons

Polycyclic Aromatic Hydrocarbons (PAHs) are found in the asphalt and tar used in road construction and repair and as by-products of fuel burning. It is possible for PAHs to leach into sediment and runoff during rain events. As a pollutant, PAHs are of concern because some compounds have been identified as causing cancer, mutations and birth defects (carcinogenic, mutagenic, and teratogenic) and some can build up in the tissues of people and wildlife (bioaccumulate).

### 3.9 Metals

Metals can be present on site naturally within soils (in particular in ultramafic soils in the Richmond Ranges), from previous soil contamination (eg orchards, sheep dips, etc) or from materials used onsite (eg zinc roofing, agrichemicals).

Metals are of concern as in sufficient concentrations they can cause acute or chronic poisoning and a wide range of adverse health effects. In addition, some metals bioaccumulate – meaning they increase in concentration in a biological organism over time, compared to the concentration in the environment. This is of particular concern in areas used for food gathering – for example in estuaries where shellfish may become toxic.

Metals in soils are often bound to fine sediments and therefore minimising fine sediments in runoff may reduce total metals concentrations being discharged.

### 3.10 Non-sediment contaminants

In addition to sediment, some land disturbing activities, in particular construction, can contribute other contaminants to receiving systems, impacting human health, water quality and aquatic wildlife. The control of non-sediment contaminants should also be considered on individual projects, especially if fuel or other potential contaminating materials are stored on site. The same practices that are used for controlling sediment may provide for control of non-sediment contaminants, but each site should consider the range of potential contaminants that will be present to ensure that the required controls are in place and there is no inappropriate discharge.

#### 3.10.1 Construction Materials

Construction can involve the use of a wide variety of materials with the potential to produce metal, wood, plastic off cuts and other debris that can be blown or washed downstream if not properly managed.

Cement is probably the single most important non-sediment contaminant discharged from building sites. In addition, chemicals associated with construction materials, machinery and equipment (such as creosote, chromium and arsenic treated wood, paint, adhesives, solvents and vehicle oils, fuel and grease) can leach or wash from equipment and materials during storm events. Asphalt and concrete contain chemicals that can alter pH or have toxic effects to aquatic organisms. In addition, commonly used landscaping and farming materials such as fertiliser, mulch, lime and pesticides can contribute nutrients, oxygen-demanding material and toxic contaminants.

### 3.11 Sediment Transport Pathways

The ways in which sediment can move off site and the proximity of the disturbed area to a receiving system are vital when considering the possible impact that site works can cause. Key ways that sediment can move across and off site include (refer 3-14):

- Wind blown
- Overland flow
- Concentrated flow - such as in streams
- Vehicle movements – in particular via wheel treads
- Physical dumping (both legal and illegal)
- Stormwater pipes and structures, or
- Natural features such as karst sinkholes.

Some pathways transport sediment more rapidly than others providing less opportunity for deposition to occur prior to discharge. For example, having unprotected stormwater drains on site would allow for almost 100% delivery to the receiving environment.

In a similar fashion, where the disturbed land activity is near or adjacent to the receiving environment there is little buffering available, and sediment can be transported rapidly.

Identification of all potential pathways is necessary to provide context on potential receiving system impacts and assist in developing effective erosion and sediment control plans with appropriate controls located in appropriate places.



Figure 3-14 Source, Pathway and Receiving Environment

# Chapter 4

## Receiving Environments

NELSON TASMAN  
**EROSION AND SEDIMENT  
CONTROL GUIDELINES**

JULY 2019





## TABLE OF CONTENTS

<b>4</b>	<b>RECEIVING ENVIRONMENTS</b>	<b>1</b>
4.1	Adjacent properties	1
4.2	Infrastructure	2
4.2.1	Roads and Stormwater Networks	2
4.2.2	Protection of on-site stormwater management devices	2
4.3	Karst landscapes and cave systems	3
4.4	Streams and Rivers	5
4.4.1	Intermittent streams	5
4.4.2	Hill Fed streams	7
4.4.3	Lowland fed streams	7
4.4.4	Spring fed streams	7
4.4.5	Tasman River Water Quality	7
4.4.6	Tasman Aquatic Species	8
4.4.7	Impacts of Sediment on Rivers and Streams	9
4.4.8	Managing erosion and sediment impacts on rivers and streams	10
4.4.9	Water Conservation Order Areas	10
4.5	Wetlands	11
4.6	Lakes, farm ponds and dams	12
4.7	Estuaries	13
4.8	Open coasts	16
4.9	Visual Landscapes	17

## LIST OF FIGURES

Figure 4-1	Rain garden construction: sediment entry is compromising future performance due to clogging	3
Figure 4-2	Sinkholes in farmland, Golden Bay (Photo D. Shaw)	3
Figure 4-3	Sinkhole in Pohara, Golden Bay draining a waterway from a residential subdivision (Photo: G. Stevens)	4
Figure 4-4	Intermittent Streams in Tasman	6
Figure 4-5	Riffle and pools in an upper catchment stream	7
Figure 4-6	Fly Fishing on the Motueka River (credit B. Smithies)	8
Figure 4-7	Examples of some of the Aquatic Species in Tasman District Streams	8
Figure 4-8	Impacts of Turbidity and its Duration on Aquatic Resources	10
Figure 4-11	Example of Fine Sediment Deposition in Waimea Estuary	14
Figure 4-12	Soft Mud as a Percentage of Intertidal Area, Tasman Estuaries (Robertson and Stevens, 2009 and 2013)	14
Figure 4-13	Sediment Plume in Waimea Estuary from mud resuspended by wave action	15
Figure 4-14	West Coast (near Patarau) Inlet	16
Figure 4-15	Consideration of landform in road layout and building platform design	17
Figure 4-16	Visual impact of land disturbance	18

## 4 RECEIVING ENVIRONMENTS

Understanding where water goes and the sensitivity of receiving environments will assist in determining requirements for erosion and sediment control for land disturbing activities and also help determine risk. Receiving environments have value, are vulnerable and require a greater level of protection than has previously been afforded.

Receiving environments from an erosion and sediment control perspective include the following:

- Adjacent properties
- Infrastructure – such as the stormwater pipe network and roads
- Karst landscapes and cave systems;
- Streams and Rivers
- Wetlands
- Lakes, farm ponds and dams
- Estuaries
- Coast; and
- Visually Significant Landscapes.

Each of these environments are discussed in the following sections.

In addition to ecological values, with all receiving environments there is potential for human interaction, whether this is for recreational purposes, water use or food gathering. Understanding who the potential users of receiving environments are should be included when considering the potential for adverse effects on a receiving environment.

### 4.1 Adjacent properties

Sediment, dust or sediment laden runoff can exit a property and be deposited on adjacent land, including neighbouring private properties, public roads and reserves. The adjacent land can be considered a receiving environment. When undertaking land disturbance, minimise any potential adverse impacts to adjacent land. Discharges to neighbouring properties are a common source of complaint.

Note: Good practice for erosion and sediment control still needs to be undertaken within your own property boundaries.

Dust from land disturbing activities can cause:

- Respiratory health issues
- Contamination of roof water supplies
- Crop damage
- Adverse visual effects
- Widespread nuisance.



Key elements to minimising land disturbance effects on adjacent properties include:

- Know your property boundaries.
- Understand who your neighbours are, and how erosion, sediment and dust from your site might affect them.
- Understand the sediment transport pathways for how sediment or dust may move off your site (refer Chapter 3, section 3.11) and implement appropriate controls.
- Monitor the weather forecasts and dampen down or cover exposed areas if winds are forecast, check all controls and transport pathways if rainfall is forecast.
- Check your boundaries with adjacent properties regularly, particularly after heavy rain, and if sediment has deposited assess likely remedial actions.

## 4.2 Infrastructure

### 4.2.1 Roads and Stormwater Networks

Deposition of sediment onto roads and footpaths causes a nuisance to users, can be a safety issue, and during storm events these sediments can enter the stormwater system, potentially clogging parts of the network causing flooding or discharging into local streams and coastal environments.

Key elements to minimising land disturbance effects on infrastructure include:

- Understand the sediment transport pathways for how sediment or dust may move off your site and into infrastructure networks (refer Chapter 3, section 3.11) and implement appropriate controls.
- Identify and protect all existing and new stormwater reticulation on site to avoid discharge of sediment to these networks.
- Check your boundaries with roads and footpaths regularly and remove any sediment discharged from your site promptly.
- Inspections of site vehicle access points should be made at least at the end of each working day and roads and footpaths cleared of any sediment dropped from vehicles leaving your site. Review management of your vehicle access if vehicles are tracking sediment onto roads (eg renew aggregate protection or install a wheel wash if appropriate).

### 4.2.2 Protection of on-site stormwater management devices

Where stormwater management devices (eg wetlands, swales, raingardens, filters, etc) are to be used permanently on site for stormwater management, it is vital that these are protected from excessive sediment discharge while construction activities are continuing in their respective contributing catchments.



This is a particular issue where Low Impact Design (LID) stormwater devices have been installed in subdivisions that then have individual site developments, which can cumulatively affect the functioning of the devices.

The party responsible for the LID device (usually the subdividing developer or the Council) needs to ensure the devices are protected from sediment generated by individual building sites and any other land disturbance occurring in the contributing catchment. Individual site developers should also be managing their sites to ensure sediment does not travel off site.



Figure 4-1 Rain garden construction: sediment entry is compromising future performance due to clogging

Use of LID devices as sediment controls during construction is not an acceptable practice unless those devices have been specifically designed for use during ongoing construction and they are reinstated once land disturbance has ceased to effectively perform their intended ongoing stormwater management function.

Failure to adequately protect devices may result in the need to reconstruct or clean out devices before they can be used to manage onsite stormwater. At subdivision stage LID device owners should consider including instruments on property record of titles (eg consent notices) to require future site developments to ensure protection of these devices.

### 4.3 Karst landscapes and cave systems

Karst landscapes are present in parts of Golden Bay, along the Takaka Valley, Takaka Hill and the Arthur Range and south-west of Tapawera around Mt Owen (Figure 3.3). Karst systems are vulnerable to land disturbance of any type that allows mobilised sediment to enter the system.

Karst topography is characterised by subterranean limestone (CaCO<sub>3</sub>) caves and surface features carved by rain and groundwater. These areas have unique ecologies, both above and below the ground. Often the linkages of subsurface cave systems and surface features is not well known and impacts from land disturbance may have unforeseen impacts in unexpected ways.

Within karst landscapes there is clear evidence that alteration of vegetative communities of any sort can lead to substantial and potentially irreversible impacts on the karst processes operating in that area (Urich, 2002).



Figure 4-2 Sinkholes in farmland, Golden Bay (Photo D. Shaw)

Problems in karst areas can also result from transport of sediment from upslope non-karst catchment into a karst landscape.



Figure 4-3 Sinkhole in Pohara, Golden Bay draining a waterway from a residential subdivision (Photo: G. Stevens)

Environmental issues related to land disturbance in karst terrains include:

- Soils in karst terrains are moderately-well to well drained, and there is little surface runoff. Rainwater is diverted underground through sinkholes and/or by diffuse recharge through the overburden into numerous small fractures in the limestone.
- Contaminants can pass rapidly through the subsurface system with little or no modification other than dissipation.
- Long residence times, confined aquifers and lack of natural filtration create special needs regarding groundwater protection in karst, particularly where groundwater resources are used by local communities.
- Karst ecologies include rare and unusual species which can be very sensitive to changes in water flows and water chemistry that can result from sediment deposition (Richards 2003).
- Accelerated erosion and changes to water flow paths can result in flooding, subsidence or ground collapse of surface areas (Richards 2003).
- Karst landscapes often include areas that are of particular cultural and spiritual significance, as well as recreational importance eg Harwood Hole on Takaka Hill.
- Many subterranean karst systems are uncharted and sediment inputs may have unanticipated impacts on unexpected areas.

Key elements to managing land disturbance on karst landscapes or areas that drain to karst landscapes include:

- Identify all streams, sinkholes, springs or cave entrances on site and include these on any sediment and erosion control plans
- Minimise site disturbance and changes to soil profile, including minimising cuts, fills, excavation and drainage alteration
- Where possible, runoff should be maintained as sheet flow to avoid it becoming concentrated, with flows dispersed over the broadest area possible to avoid ponding, concentration or soil saturation
- Avoid changing flow patterns and volumes entering subterranean systems (eg via sinkholes). Do not direct stormwater into caves/tomos/sinkholes – whether open or closed
- Retain and enhance vegetation within and near sinkholes, springs, and cave openings to help reduce sediment movement into karst water bodies and help protect ecologies in these areas
- Install erosion and sediment controls around staging areas to prevent discharge from these sites.

- Sediment retention ponds should only be used as a last resort after all other sediment control options have been considered. In instances where they are employed, they should serve small catchment areas (< 2 ha), be lined with an impermeable liner to prevent or minimise infiltration and be located away from karst features.
- Keep the following activities away from karst features such as any stream, sinkhole, spring or cave openings:
  - Staging areas for crew
  - Equipment and refuelling of construction equipment
  - Stockpiling
  - Hazardous materials, chemicals, fuels, lubricating oils
  - Application of fertilizers, herbicides, pesticides, or other chemicals
  - Storage of construction waste materials, debris, and excess materials
  - Waste lagoons, septic systems, or storm water ponds (impermeable liners are likely to be needed)
- Contact Council if karst features, such as sinkholes, springs, and cave openings, are discovered on the project site during any aspect of project implementation for further evaluation to determine how the feature's value should be protected.
- Remove and dispose of all debris and excess construction materials properly upon project completion.
- Revegetate all disturbed areas as soon as possible and evaluate the establishment of vegetation after project completion.
- Retain sediment control structures until permanent site stabilization is completely achieved. Refer also Chapter 3, section 3.3.3.

Note: the discharge of soil, vegetation, effluent, refuse, offal, debris or stormwater into open sinkholes does not meet permitted activity rules and will require resource consent approval.

## 4.4 Streams and Rivers

Tasman has many different types of rivers and streams, including hill fed, lowland fed and spring fed (from both karst and gravel aquifer systems).

Streams and rivers can be identified with the following flow qualities:

**Ephemeral** (flowing only during or immediately after rainfall).

**Intermittent** (flows for part of the year, often dependent on groundwater conditions).

**Perennial** (flowing the majority of the time).

They can also be highly modified and be referred to as 'drains', having been straightened, channelised, diverted and stripped of vegetation (refer Chapter 11, section 2 for further discussion on this issue).

It is important to think of rivers and streams as both receiving environments and as potential sediment transport pathways to other receiving environments. Further information on undertaking activities in or around watercourses is available in Chapter 11.

### 4.4.1 Intermittent streams

Streams that stop flowing for a significant amount of time (weeks or months) during a normal year are classified as intermittent. They generally fall into two types (NIWA 2007):

1. Small streams at the very tops of headwaters which go dry as the stream network contracts during the dry season.



2. Larger 'mid-reach' streams or rivers may have permanent flow in their headwaters but lose water when they cross an area where the water table sometimes falls below the level of the stream bed.

Tasman has many intermittent streams. For example, many hill-fed streams in the Moutere area and mid Takaka Valley tend to have an intermittent or ephemeral flow, especially if the wetlands that once existed in the valleys have been removed. Borck Creek west of Richmond has intermittent flow in its mid reaches where it crosses over gravel deposits.

Intermittent streams often still have a well-defined bed with exposed aggregate (cobbles etc) as seen in the photos in Figure 4-4. In some cases, if no-flow periods are prolonged, fast growing plant species may colonise the bed.

Intermittent watercourses typically have ecologies suited to the intermittent nature of the water flow and can provide habitat for some rare and unique stream species. Aquatic species that rely on intermittent stream areas may utilise a number of refuges during dry periods including burrowing into the bed, surviving in the groundwater below the bed or migrating to nearby flowing sections. Riparian vegetation is particularly important in protecting many of these refuges and their dependent ecologies during dry periods (NIWA 2007).



Figure 4-4 Intermittent Streams in Tasman

#### 4.4.2 Hill Fed streams

Just over half the streams in the Tasman district have their source of flow in hill country and a quarter of the streams are fed by mountainous areas (>1000m high).

Streams in upper catchments tend to be in the form of a series of riffles and pools. The riffles and pools, in conjunction with woody vegetation form the primary habitat for aquatic life.



Figure 4-5 Riffle and pools in an upper catchment stream

Hill fed streams can experience high sediment inputs due to the steepness of adjacent slopes, particularly in areas with readily erodible soils, however they are not as vulnerable to settlement of sediments as water velocities are higher. These streams can act as transport pathways to downstream, lower velocity water bodies where sediments settle out. Control of erosion is therefore important in hill areas flowing into streams.

Control of erosion is therefore important in hill areas flowing into streams.

#### 4.4.3 Lowland fed streams

Approximately a quarter (24%) of the streams in Tasman are lowland-fed. There are relatively few soft, or muddy, bottomed streams, but the lower gradient portion of smaller catchments in the Moutere Hill country (in Moutere Gravels) tend to be muddy bottomed due to flatter slopes and less erosion energy to ream out the fine sediment.

Lowland streams can have slower moving water allowing greater deposition of sediments from both local and upstream sources. To an extent, sediment accumulation in streams of the lower floodplains is natural. However, this was greatly accelerated by forest clearance over the last two centuries and many streams continue to be under pressure from rural and urban sediment sources. Lowland streams provide habitat to species such as short-fin eels adapted to these conditions.

Small lowland stream ecosystems are more vulnerable to sediment effects than larger rivers and sediment impacts are greatest at times of low flow.

#### 4.4.4 Spring fed streams

The spring-fed streams in Tasman have both karst and alluvial aquifer sources. There is karst fed streams in the Takaka and Riwaka areas (Waikoropupu springs being one of the most famous) and alluvial aquifer fed streams in lower Takaka (Motupipi), Murchison Creek, Motueka, Tapawera, Kohatu and the coastal creeks in the Waimea Plains.

Spring-fed streams are the most vulnerable stream type to sedimentation due to the absence or infrequent nature of floods that would flush out the sediment.

#### 4.4.5 Tasman River Water Quality

Many rivers in Tasman are known for their excellent water clarity (eg Waingaro River, Upper Motueka, Upper Matakītaki and Riwaka). Average base-flow water clarity across the district ranges between 2 and 8m, with water clarity over 60m at the Waikoropupu Springs in Golden Bay.

The poorest water clarity in Tasman is found in small farmland streams, particularly those in the Moutere hills due to the type of clay soils and the associated land uses.



There are a large number of karst springs in the Tasman District that have good water clarity, particularly in Mt Arthur marble country (eg Pearse River Resurgence). The alluvial spring sites such as Motupipi River and Murchison Creek would also be expected to have high water quality, but activities in the catchments of these streams are reducing water clarity.

About 30% of the Council’s river water quality monitoring sites in developed catchments have water quality that is either moderately or severely degraded. These streams are often in smaller catchments and in urban areas where streams can contain heavy metals and elevated sediment, or in agricultural catchments where vegetation clearance and land development has caused increased water temperatures and greater accumulation of silt on the streambeds.

It is important to protect those streams with good existing water quality, as well as avoid exacerbating the situation in those with degraded water quality.

#### 4.4.6 Tasman Aquatic Species

Twenty species of native fish exist in Tasman, most of which are nocturnal. This variety of fish makes the regions freshwater fishery one of the most diverse in New Zealand. Sediment discharges and habitat degradation (particularly from infilling the bed matrix) are regarded as major reasons for the decline in the diversity of native fish populations in pastoral and urban streams (Joy, 2009).

Excess sediment can also profoundly affect the productivity of salmon and trout streams impacting the recreational use of these fisheries in Tasman. Sediment affects spawning grounds by impeding sub-gravel flows and smothering eggs, as well as clogging habitat sites and reducing food sources.



Figure 4-6 Fly Fishing on the Motueka River (credit B. Smithies)

Giant Kokopu



Inanga



Banded Kokopu



Giant Bulli



Koura



Figure 4-7 Examples of some of the Aquatic Species in Tasman District Streams

#### 4.4.7 Impacts of Sediment on Rivers and Streams

The three keyways in which land disturbance and sedimentation can adversely affect rivers and streams are:

- 1) Habitat degradation or destruction.
- 2) Waterway channel capacity reduction, and
- 3) Water quality degradation.

Streams and rivers can be considered stable if the banks are relatively stable and the water flow and sediment load are in balance. Occasional periods of high levels of suspended solids (turbidity) or long durations of moderate suspended solids and the resulting deposited fine sediment can adversely affect physical stream habitat and food resources for stream invertebrate and fish communities. Unlike contaminants such as nutrients, the ecological response to fine sediment discharges is almost always adverse right from small concentrations (Quinn 2000).

The adverse impacts of sediment discharges on stream habitats, aquatic plants and animals have been extensively studied. The key impacts of sediment in stream and river environments are:

- Destroying aquatic habitat by filling in pool areas making the stream bottom homogeneous with little habitat diversity and limiting the types and abundance of aquatic animals and plants the waterway can sustain
- Reducing flow carrying capacity, potentially increasing flooding risks, as the stream cross-sectional area reduces due to deposition in the stream bottom
- Smothering of bottom dwelling organisms where sediment deposition occurs faster than they are able to cope with (even within low energy muddy bottomed stream reaches) - usually in the order of a 20% increase in fine sediment in the bed.
- Scattering and absorbing light, reducing light available for photosynthesis by aquatic plants and making it harder for predatory macroinvertebrates and fish to see their food
- Damage to fish and macroinvertebrate food supplies due to the destruction and degradation of biofilms on stream bed substrates and the filling of streambed features, such as crevices and interstitial spaces, where organic matter would normally collect
- Damage to the fine gills and mouth parts of macroinvertebrates and fish due to the abrasive suspended sediment and stressing of animals affecting growth and mortality rates
- Impacts on the reproduction of fish species by inhibiting the annual colonisation of headwater streams by migratory and juvenile fish and the destruction of developing eggs and newly hatched fry by shifting sediment in pools and runs.

The flow-on effect of degraded stream habitat and poor food resources in a stream is usually seen throughout the food web. Invertebrate abundance is reduced along with a change in stream invertebrate community composition; this then also impacts other species up the food chain.

Figure 4-8 provides a general indication of the impact increased turbidity has on aquatic resources (NIWA, UW ERC 2010). This illustrates increased effect with higher levels of turbidity and in particular for longer periods of time.

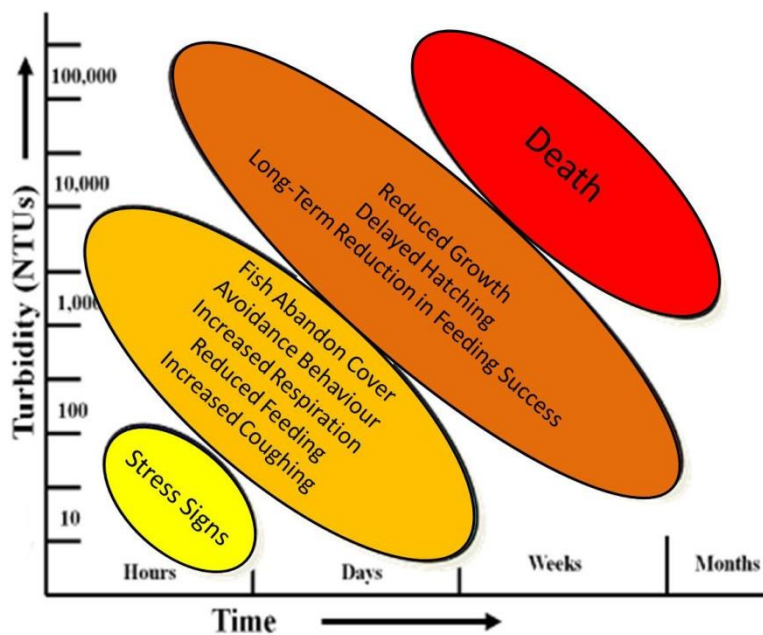

Figure 4-8 Impacts of Turbidity and its Duration on Aquatic Resources

#### 4.4.8 Managing erosion and sediment impacts on rivers and streams

Key elements to managing land disturbance impacts on rivers and streams include:

- Understand where the streams and rivers are on your site, including both low flow channels and flood flow channels. Include these with your Erosion and Sediment Control Plans. Don't forget ephemeral channels and gullies – these can be important sediment transport pathways
- Understand what fish species might be present at your site. This will provide information on fish passage requirements, as well as assisting in determining appropriate times of the year for undertaking works in or around watercourses (refer Chapter 11 and Appendix 13.8).
- Ensure that in both low flow and flood flow areas that exposed earth is minimised and no stockpile storage occurs.
- Separate watercourse areas from land disturbance activities by appropriate sediment controls.
- Treat all watercourses – including highly modified drains and small watercourses- as both receiving environments and potential sediment transport pathways to other receiving environments downstream.

Note: resource consent may be required for works in or around rivers and streams (refer Chapter 11 on activities in and around watercourses).

#### 4.4.9 Water Conservation Order Areas

Two Water Conservation Orders have been issued for watercourses in the Tasman District. They are for the Buller River (2001), and the Motueka River (2004).

Both rivers are relatively intact by New Zealand standards and have a diversity of sub-catchments, gorges, lakes and tarns supporting a nationally significant native fishery and sports fishery.

In the case of the Buller River, Lake Rotoiti, Lake Constance, and Lake Rotoroa have been identified as waters to be retained in their natural state. Lake Matiri has been identified as protected waters.



The purpose of these two orders is to protect the outstanding characteristics and features of waters including:

- Outstanding recreational characteristics
- Outstanding wild and scenic characteristics
- Outstanding fisheries or wildlife habitat features, and
- Outstanding scientific values.

Due to their outstanding characteristics the orders identify the following for individual components of the two watercourses:

- Waters to be retained in natural state
- Waters to be protected
- Restrictions on damming of waters
- Restrictions on alterations of river flows and form
- Restrictions on alteration of lake levels
- Requirement to maintain fish passage, and
- Restrictions on alteration of water quality – including those associated directly with sediment discharges.

The orders clearly highlight the importance of these two catchments and the orders need to be reviewed for projects contained in the Buller or Motueka catchments for requirements in specific areas. Discuss with Council staff before commencing any land disturbance work in these sensitive receiving environments.

## 4.5 Wetlands

Wetlands mostly occur where the groundwater table is close to or at the ground surface or where stream flow enters a flat area and water tends to pond. Wetlands are some of the most productive environments in the world, particularly in terms of species diversity and growth rates.

The TRMP and the NRMP define a Wetland as **–‘permanently or intermittently wet areas, shallow water, and land water margins that support a natural ecosystem of plants and animals that are adapted to wet conditions’.**

A wetland could be a lagoon, salt marsh, bog, fen, swamp, shallow lake, margin of a river, and could even include some mature farm drains and dams. The look of a wetland and its mix of plants and animals will vary with local conditions (for example climate, water flow, altitude and substrate). Several different types of plant and animal communities may be present in larger wetlands, and all wetlands change over time.

Wetlands may provide:

- Flood retention and protection
- Water quality benefits
- Important nursery and feeding grounds for fish, birds and invertebrates
- Wildlife habitat
- Amenity and landscape value Important social and recreational values (eg for fishing, boating, walking)
- Important cultural values to Maori, providing traditional sources of food, plants for weaving, medicines, and taonga sites.

Wetlands provide the greatest concentrations of bird life of any habitat in New Zealand and support far more species than a comparable forest area. Migratory species depend on wetlands of suitable size, often linked to other important habitats by intact corridors.

In addition to values for birds, native fish also need wetlands. Eight of New Zealand's 27 fish species are found in wetlands while the whitebait fishery depends on spawning habitat offered by freshwater wetlands.

Wetlands are found across the District, from the mountain ranges to the coast, however more than 90% of Tasman and 99% of Nelson District's natural, lowland wetlands have gone, especially those in the lowland areas of Moutere, Motueka, Golden Bay and Waimea. In respect of private land in the Motueka and Waimea areas, 95-97% of wetlands have disappeared (TDC 2005). Few large wetlands remain and of the remaining wetlands, more than half are less than 0.5 hectares in size or are not naturally occurring.

Most of the remaining wetlands in the lowland areas below 100 metres above sea level are in private ownership and are vulnerable to economic pressure to develop land. Infilling and increases in sediment inputs are two of the key threats to these wetlands. It is vital that remaining wetlands are protected from degradation.

Key elements to managing land disturbance impacts on wetlands include:

- Understand where the wetlands are on your site, as well as downstream of your site, some wetland areas may not be immediately obvious due to degradation through grazing and vegetation removal, however given a chance these areas can regenerate or be restored. Identify these on your erosion and sediment control plans.
- Separate these areas from land disturbance activities by appropriate sediment controls.
- Ensure that no stockpile storage occurs within wetland boundaries or where sediment may enter wetlands.
- Avoid machinery and stock gaining access to wetland areas.
- Wetlands often flow to other areas, treat all wetlands – even modified ones, as both receiving environments and potential sediment transport pathways to other receiving environments.

Note: Resource Consent may be required for works in or adjacent to wetlands.

## 4.6 Lakes, farm ponds and dams

The TRMP defines a lake as – ***'a body of fresh water which is entirely or nearly surrounded by land but does not include any artificial pond or water supply impoundment less than one hectare in area'***.

The NRMP does not have a definition of a lake and the term lake is be found within the definition of - Water body\* freshwater or geothermal water in a river, lake, stream, pond, wetland, or aquifer or any part thereof, that is not located within the coastal marine area.

In the Tasman District most large natural lakes are surrounded by conservation land and there are only five with any threat from sediment discharges (Wharariki, Killarney, Kaihoka (2) and Otuihe).



Figure 4-9 Kaihoka Lake (T.James)

Farm ponds and dams are scattered throughout the district. In peri-urban areas these may be retained and incorporated within developments as amenities. Sedimentation of farm ponds can impact on their capacity and use for stock watering and irrigation.

Do not assume that farm ponds are suitable for use as sediment retention ponds – these may also be part of a natural system and therefore receiving environments. This is particularly relevant in karst landscapes where ponds may have developed from sink hole features.

Lakes and ponds trap sediments that enter them as due to the very low flow velocities the sediment drops to the bottom. Materials that enter a lake tend to remain in the lake so they are sinks where contaminants can accumulate. Over time lakes and ponds become shallower and without natural flushing or human intervention are most likely to eventually fill in. These processes mean that shallow lakes and ponds are more susceptible to accelerated sedimentation from land disturbing activities.

While sedimentation is a key stressor, nutrient inputs are considered to be the key issue for lake health. Lakes are considered as having a moderate sensitivity to impacts from sedimentation.

Key elements to managing land disturbance impacts on lakes, ponds and dams include:

- Understanding the sediment transport pathways on your site which lead to these water bodies.
- Ensure that no stockpile storage occurs within or near lake margins or where sediment may enter waterways flowing into lakes.
- Avoid machinery and stock gaining access to lake margins.
- If works are being undertaken within lake environments ensure appropriate erosion and sediment control practices are implemented, including undertaking work in dry conditions where possible (refer Chapter 11).

Note: Resource Consent is likely to be required for works adjacent to or in the bed of a lake.

## 4.7 Estuaries

Estuaries are low energy, depositional zones where streams meet the sea. Estuaries are among the most productive ecosystems in the world and provide rich feeding grounds for coastal fish and migratory birds and spawning areas for fish and shellfish making them particularly important to local fisheries.

Estuaries are subject to both freshwater and marine influences, including freshwater inflow and sediment entry. Due to very shallow gradients and significant tidal influence they tend to be depositional areas subject to rapid infill due to sediment entry. In addition to the sediment being deposited due to low transporting energy, estuaries increase sedimentation through flocculation where salts combine with clay materials to enhance deposition of fine sediments. As a result of these two processes they are subject to severe degradation from land-based activities.

Over the last 150 years the rate of infilling in New Zealand's estuaries has accelerated as a result of extensive catchment clearance, wetland drainage and land development for agriculture and settlements. Estuaries were commonly dominated by sandy sediments and had low sedimentation rates prior to human settlement (eg <0.5mm/year (Swales et al 2002, mead and Moore, 2004, Robertson and Stevens 2011).

As low energy, depositional environments the natural infill of an estuary may take hundreds of years, however accelerated sedimentation can fill an estuary in several years. The physical effects of catchment soil erosion will be greatest in the tidal creeks at catchment outlets, whereas the ecological effects of increased fine sediment loads will be more critical in the main body of estuaries (Swales et.al., 2002).

Nelson and Tasman Districts are home to several internationally and nationally significant estuaries and sand flats including:

- Waimea Inlet
- Moutere Inlet
- Motueka Delta
- Motupipi Inlet
- Ruataniwha Inlet, and
- Whanganui Inlet.



Figure 4-9 Example of Fine Sediment Deposition in Waimea Estuary

They are significant due to the rich life they support, including several threatened and migratory species of bird and are important for fish, including several commercial and recreational species. Seagrass (*Zostera*) beds are particularly important intertidal habitats in the Districts supporting very diverse and abundant ecological communities. These beds are also very vulnerable to fine sediment inputs. The Waimea estuary has lost 64% of its seagrass since 1988 (from 58Ha to 21Ha).

There are also many smaller estuary environments along the Nelson Tasman coastline such as Pakawau, Parapara, Onekaka, Onahau, Tata, Kaiteriteri and the Otuwhero inlet to name a few.

The 2010 State of the Environment report (TDC, 2009) identified that human and ecological values within the main estuaries were moderate to high, and habitats included saltmarsh, seagrass, unvegetated tidal flat habitats, and highly modified terrestrial margins.

In terms of sedimentation, the area of soft mud in some estuaries, particularly Waimea and Motupipi, was very elevated (a “poor” rating) and was expanding in area in the Waimea Estuary having increased by 26% since 2001. The soft mud area was also elevated in the Ruataniwha and Motueka estuaries and rated at “fair” levels. More recent investigations of the Moutere Estuary have shown over a 170% increase in the area of soft mud substrates between 2006 and 2013 (from 14 to 38.1% of the total substrates) and a “poor” rating.

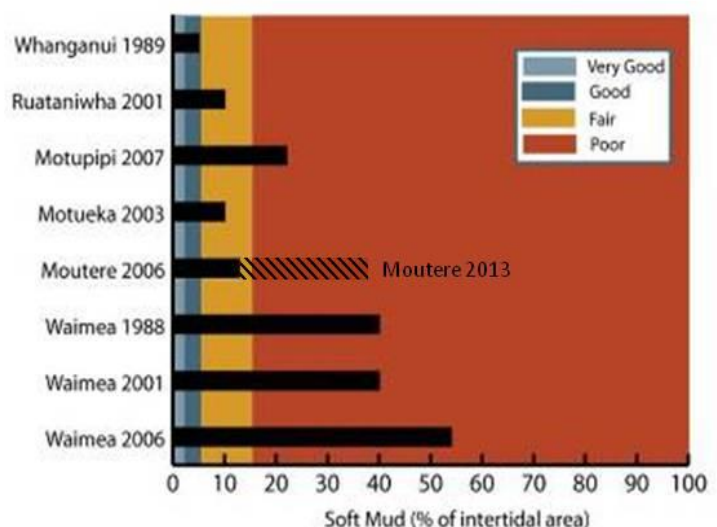

Figure 4-10 Soft Mud as a Percentage of Intertidal Area, Tasman Estuaries (Robertson and Stevens, 2009 and 2013)

Figure 4-12 shows the percentage of soft mud in intertidal areas of Tasman estuaries. The percentage of soft mud ranges from a low of 5% for the partially modified Whanganui Estuary, to 54% for the highly modified Waimea Estuary (note latest 2013 Moutere data included as hatched bar).



Muds decrease sediment oxygenation and lower biodiversity and, if they contain low organic material, decrease productivity. As sediment anoxia (lack of oxygen) promotes nutrient release, muddy estuaries become increasingly sensitive to nutrient inputs (promoting algae growth) and further anoxia. Sedimentation is also partly responsible for the significant historical loss or modification of valuable saltmarsh habitat.

Studies (Lohrer, et.al., 2004; Gibbs, Hewitt, 2004) undertaken on the impacts of sedimentation on estuarine systems highlighted that:

- The number of individuals and taxa declined as a result of sedimentation, as did the densities of nearly every common species.
- As little as 3mm of deposited material was sufficient to significantly alter macrobenthic communities (animals living in estuary beds).
- Large depositions (over 3cm) caused macrofauna die off within 10 days.
- Thinner depositions (1.5-2cm) had an immediate effect with slow recovery (210 days).
- Repeated depositional events did more damage than single ones.

In addition to the biological and ecological effects from accelerated erosion, sediment-laden discharges are considered unappealing from an aesthetics perspective. Clean water is something that people consider to be of value as part of the 'Clean & Green' image of New Zealand, especially at the 'gateway' to Abel Tasman National Park.



Figure 4-11 Sediment Plume in Waimea Estuary from mud resuspended by wave action

Key elements to managing land disturbance impacts on estuaries include:

- Understand the sediment pathways on your site which lead to estuaries, this could be directly if works are in coastal areas, via overland flow or streams and stormwater networks. Windblown dust can also deposit sediments into nearby estuary environments
- Ensure that no stockpile storage occurs within estuary margins or where sediment may enter water bodies
- Avoid machinery and stock gaining access to estuary margins
- If works are being undertaken within coastal environments, ensure appropriate erosion and sediment control practices are implemented.

Note: Resource Consent may be required for works in or adjacent to estuarine areas.

## 4.8 Open coasts

Open coasts are dynamic environments and go through constant change. Tasman has a diverse coastline, from the rugged exposed west coast through to the relatively sheltered Golden Bay and Tasman Bay.

Sedimentation is a natural component of coastal environments. However, accelerated sedimentation can be an ongoing concern on coasts with sediment plumes creating visual pollution, impacting on light penetration and potential adverse impacts on coastal reef communities and offshore aquaculture fisheries.

Consideration of sedimentation issues on offshore areas is difficult to assess as much less is known about the various modes and mechanics of transport to be able to make an accurate assessment of potential impacts.



Figure 4-12 West Coast (near Patarau) Inlet

There are issues related to littoral drift and offshore sediment transport along, towards or away from the coast.

There are few studies that have documented these effects. Monitoring of the Motueka River plume as part of the Motueka Integrated Catchment Management project showed that the influence of the river plume extended out to around 7 km offshore from the river mouth and the detectable sedimentation footprint covered an area of about 180 km<sup>2</sup>, including areas with significant existing and potential fishery values. (Cawthron 2010).

Key elements to managing land disturbance impacts on open coasts include:

- Understand the sediment pathways on your site which lead to the coast, this could be directly if works are in coastal areas, via overland flow or streams and stormwater networks. Windblown dust can also deposit sediments into nearby coastal environments.
- Ensure that no stockpile storage occurs within coastal margins or where sediment may enter water bodies.
- Avoid machinery accessing coastal margins.
- If works are being undertaken within coastal environments, ensure appropriate erosion; and sediment control practices are implemented.

Note: Resource Consent may be required for works in or adjacent to coastal areas.

## 4.9 Visual Landscapes

The visual impacts of land disturbance can affect any area able to see the site. Many effects are temporary, only occurring for the duration of works and progressively reducing following permanent stabilisation of exposed sites. However, there are some land disturbing activities that result in permanent changes to the environment which can have ongoing adverse visual effects. These include:

- Batter faces from roads, tracks, landings and building sites cutting across slopes
- Changes to ridgelines from recontouring activities
- Removal and change of vegetation cover
- Destabilization of soils and slopes resulting in ongoing erosion and development of bare scarp faces.

Key aspects for managing the visual effects of land disturbance include:

- Considering where your site could be seen from, in particular publically accessible sites such as parks, reserves, beaches and roads.
- Knowing if your site is in an area (eg the Coastal Environment) or contains a feature (eg a ridgeline identified on the TRMP planning maps) which have specific land disturbance controls.
- Identifying layouts and routes for roads, tracks, landings and building platforms that:
  - Complement land contours and minimise the need for significant earthworks
  - Minimise batter heights
  - Uses less visibly prominent parts of sites
  - Minimises road and track lengths and numbers
  - Enables permanent stabilisation or revegetation of exposed soils
- Retaining and utilising existing trees and vegetation and/or undertake planting to help hide exposed batter slopes from view.
- Ensuring batter slopes are not overly steep, using benching if necessary, to enable permanent revegetation, particularly on dry north facing slopes.
- Utilising suitable techniques for stabilising exposed areas both temporarily during works and permanently following works completion (refer Chapters 8 and 9).

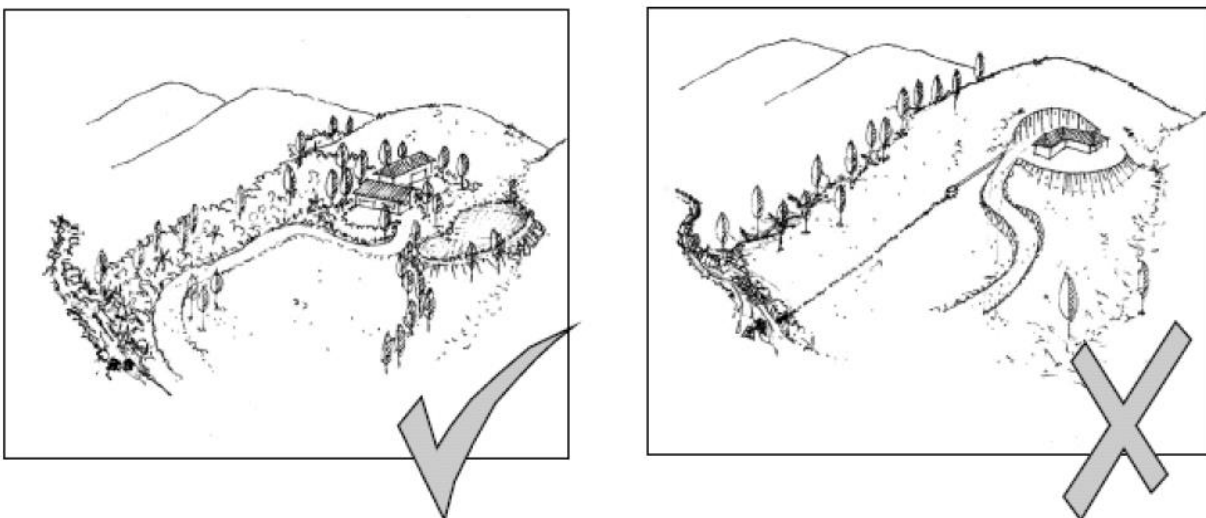

Figure 4-13 Consideration of landform in road layout and building platform design



The TRMP permitted activity rule includes conditions on the visual effects of land disturbance. Refer to the TRMP to confirm resource consent requirements in this regard.



Figure 4-14 Visual impact of land disturbance

## Chapter 5

# Risk Management Approach to Erosion and Sediment Control

NELSON TASMAN  
**EROSION AND SEDIMENT  
CONTROL GUIDELINES**

JULY 2019





## TABLE OF CONTENTS

<b>5</b>	<b>RISK MANAGEMENT APPROACH TO EROSION AND SEDIMENT CONTROL .....</b>	<b>1</b>
5.1	Levels of Risk included in Erosion and Sediment Control Design .....	2

### LIST OF TABLES

Table 5-1	Receiving Environments and Sedimentation Issues .....	1
Table 5-2	Risk based on Duration of Works and Storm Event Average Recurrence Interval (ARI) .....	3
Table 5-3	Flood Frequencies for typical land disturbance durations and desired levels of risk .....	3
Table 5-4	Receiving environments and design storms.....	5

### LIST OF FIGURES

Figure 5-1	Comparison of HIRDS rainfall intensities for locations in Tasman (reds) and Auckland (blues)	2
------------	--	---

## 5 RISK MANAGEMENT APPROACH TO EROSION AND SEDIMENT CONTROL

The likelihood that a land disturbance project could have significant adverse effects on the receiving environment is dependent on the following aspects:

- How long soil is exposed (duration of the works)
- The maximum exposed area of the works at any one time
- The use - or lack of – good site management practices
- The use and maintenance of effective erosion and sediment controls
- The slope and geology of the site (erodibility and sediment pathways)
- The location of the site and proximity of the receiving environments
- The chance of a storm occurring during the works which causes erosion and sediment transport off site.

The project manager has direct control over the first four points, and can use good onsite practice (refer Chapters 6 and 7) and a risk based approach to the design of erosion and sediment controls to minimise the influence of the slope, geology and the occurrence of storm events.

The potential for lasting effects (consequence) will depend on the sensitivity of the receiving environment(s) the site discharges to. Table 5-1 provides a general guide to the different types of receiving environments and their susceptibility to adverse effects from sedimentation.

Table 5-1 Receiving Environments and Sedimentation Issues

Receiving system	Water Quality
Estuaries	Highest potential effect
Water conservation order areas	Highest potential effect
Spring fed streams	Highest potential effect
Streams and Rivers	High potential effect
Karst	High potential effect
Wetlands	High potential effect
Lakes	Moderate potential effect
Open coast	Lower potential effect
Land	Lower potential effect

Take the time to consider which receiving environments Land Disturbance activities on your site could have an impact on and consider the pathways by which sediment may leave your site – no matter how small your site.

The scale of your Erosion and Sediment Control Plan (Chapter 7) should reflect the sensitivity of the receiving environments, the potential for sediment generation on your site and the pathways for sediment transport off your site, as a measure of your sites risk of causing sedimentation. For many environments, once damage is done it may be irreversible, so it is vital you get it right first time.

Where a discharge is to one receiving environment type which is close to a more sensitive receiving environment (eg to a stream which flows into a nearby estuary) there is an expectation that the risk assessment for the site will include consideration of the proximity of the more sensitive environment and that where practicable, use of the more stringent design standards is undertaken. Each site should be assessed on a case-by-case basis.

### 5.1 Levels of Risk included in Erosion and Sediment Control Design

Storm events are the primary cause of erosion and sediment transport off site. Short duration works may be lucky enough to be completed during a dry spell resulting in minimal opportunity for sediment pollution, however storms of any size can happen at any time in Tasman and even short duration works undertaken in the drier summer months may experience a large storm event resulting in significant off site discharges.

#### Key fact

The longer the duration of the works the greater the chance of a specific sized storm event occurring during the time that soils are exposed and vulnerable to erosion.

Due to the highly variable nature of rainfall (refer ) and soils in Tasman, the Council has decided to utilise a risk based approach to erosion and sediment control design, based on the chance of a storm occurring during the works, the site characteristics and the sensitivity of receiving environments.

The Council considers this an equitable approach to management of works across the district as everyone provides for the same level of receiving environment protection. The level of acceptable risk selected seeks to strike a balance between the risk to the receiving environments and the practicability of erosion and sediment controls.

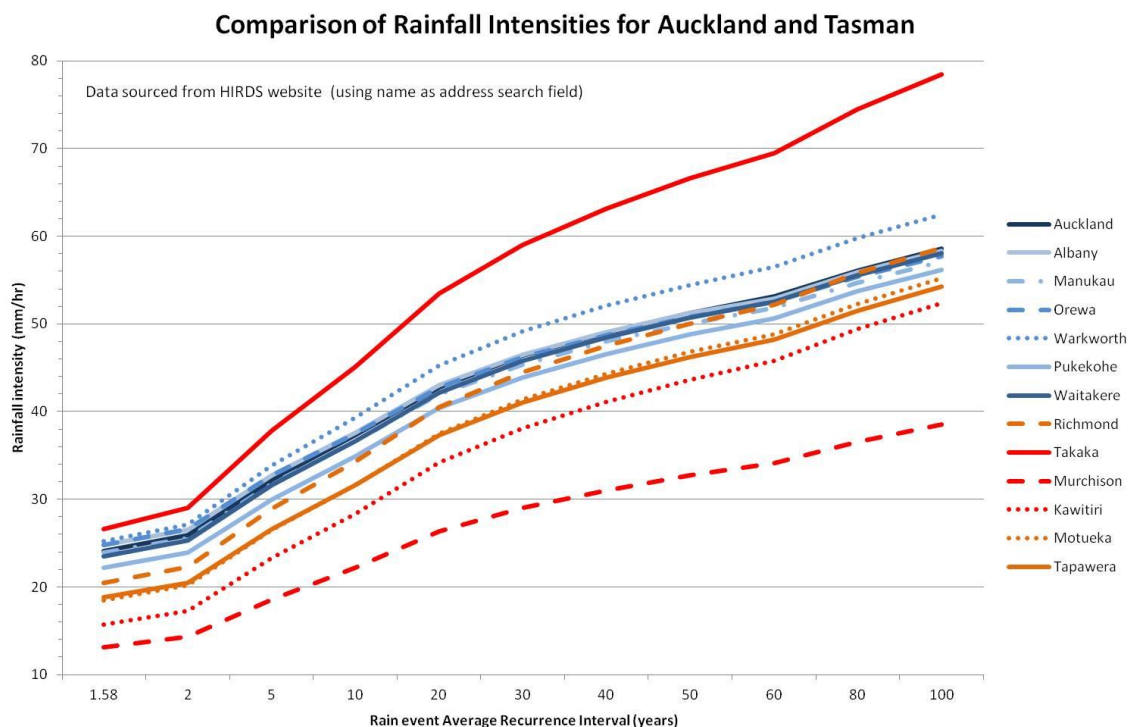

Figure 5-1 Comparison of HIRDS rainfall intensities for locations in Tasman (reds) and Auckland (blues)

Three categories of acceptable levels of risk have been identified for the different types of receiving environments. These give a 97.5% 95% or 90% level of protection of the respective receiving environments depending on their sensitivity to sedimentation (refer Table 5-4). Put another way these give a 2.5% (1 in 40) 5% (1 in 20) or 10% (1 in 10) chance of a storm event occurring within the works durations identified.

Most earthworks projects in the Tasman area take between six and 12 months to complete. Longer projects are often split into distinct stages of six or 12 months.

The probability (P, in percent) that a specific flood occurring during any time period can be calculated using the following equation:

$$P = 1 - [1 - (1/T)]^n$$

'T' is the return period of a given storm threshold (eg, 100-yr, 50-yr, 25-yr), and 'n' is the duration of the works in years (MfE 2010).

For example in the table below: for works that are 12 months duration there is a 50% chance of experiencing a 2yr return event during the works, and a 20%, 10%, 5%, 2% and 1% chance, respectively, of experiencing 5yr, 10yr, 20yr, 50yr and 100yr ARI event.

Table 5-2 Risk based on Duration of Works and Storm Event Average Recurrence Interval (ARI)

Duration of Works	3mths	6mths	9mths	12mths	18mths	2yrs	3yrs	4yrs	5yrs	10yrs
Event Return Period	0.25	0.5	0.75	1	1.5	2	3	4	5	10
2	15.9%	29.3%	40.5%	50.0%	64.6%	75.0%	87.5%	93.8%	96.9%	99.9%
5	5.4%	10.6%	15.4%	20.0%	28.4%	36.0%	48.8%	59.0%	67.2%	89.3%
10	2.6%	5.1%	7.6%	10.0%	14.6%	19.0%	27.1%	34.4%	41.0%	65.1%
15	1.7%	3.4%	5.0%	6.7%	9.8%	12.9%	18.7%	24.1%	29.2%	49.8%
20	1.3%	2.5%	3.8%	5.0%	7.4%	9.8%	14.3%	18.5%	22.6%	40.1%
30	0.8%	1.7%	2.5%	3.3%	5.0%	6.6%	9.7%	12.7%	15.6%	28.8%
40	0.6%	1.3%	1.9%	2.5%	3.7%	4.9%	7.3%	9.6%	11.9%	22.4%
50	0.5%	1.0%	1.5%	2.0%	3.0%	4.0%	5.9%	7.8%	9.6%	18.3%
60	0.4%	0.8%	1.3%	1.7%	2.5%	3.3%	4.9%	6.5%	8.1%	15.5%
70	0.4%	0.7%	1.1%	1.4%	2.1%	2.8%	4.2%	5.6%	6.9%	13.4%
80	0.3%	0.6%	0.9%	1.2%	1.9%	2.5%	3.7%	4.9%	6.1%	11.8%
90	0.3%	0.6%	0.8%	1.1%	1.7%	2.2%	3.3%	4.4%	5.4%	10.6%
100	0.3%	0.5%	0.8%	1.0%	1.5%	2.0%	3.0%	3.9%	4.9%	9.6%

The frequency of storm events (ie the AEP, ARI or return period) within the typical work duration time frames has been identified to meet the desired levels of risk. These are summarised in Table 5-3.

Table 5-3 Flood Frequencies for typical land disturbance durations and desired levels of risk

Duration	3 months	6 months	12 months
Risk			
2.5% (1 in 40)	10 yr ARI	20 yr ARI	40 yr ARI
5% (1 in 20)	5 yr ARI	10 yr ARI	20 yr ARI
10% (1 in 10)	2 yr ARI	5 yr ARI	10 yr ARI



These storm sizes represent the design storms required to achieve the desired level of protection for the different receiving environments. For storms that exceed these levels it is expected that specifically designed controls will be overwhelmed, and it is likely that there will be significant discharge of sediment from sites to receiving environments. This is an unavoidable residual risk.

The receiving environments, desired risk levels and design storms are summarised in Table 5-4. This table and risk approach is used in the design methodology for erosion and sediment controls requiring specific design outlined in Appendix 13.7.

Table 5-4 Receiving environments and design storms

Category	Receiving system type	Potential for Adverse Effects from Erosion and Sedimentation	Desired design risk (chance of event occurring during works)		Storm frequency (Average Recurrence Interval) to design for (1-hour duration) (Years)				
			%	chance	Site disturbance Duration				
					up to 2 weeks	up to 1 mth	up to 3 mths	up to 6 mths	up to 12 mths
A	Estuaries	Highest	<2.5%	1 in 40	2 yr	5 yr	10 yr	20 yr	40 yr
A	Water Conservation Order Areas	Highest	<2.5%	1 in 40	2 yr	5 yr	10 yr	20 yr	40 yr
A	Spring fed streams	Highest	<2.5%	1 in 40	2 yr	5 yr	10 yr	20 yr	40 yr
B	Streams and Rivers	High	<5%	1 in 20	*85% of 2 yr	2 yr	5 yr	10 yr	20 yr
B	Wetlands	High	<5%	1 in 20	*85% of 2 yr	2 yr	5 yr	10 yr	20 yr
B	Karst	High	<5%	1 in 20	*85% of 2 yr	2 yr	5 yr	10 yr	20 yr
B	Lakes	Moderate	<5%	1 in 20	*85% of 2 yr	2 yr	5 yr	10 yr	20 yr
C	Open coast	Low	<10%	1 in 10	*85% of 2 yr	*85% of 2 yr	2 yr	5 yr	10 yr
C	Land	Low	<10%	1 in 10	*85% of 2 yr	*85% of 2 yr	2 yr	5 yr	10 yr

## Chapter 6

# EROSION AND SEDIMENT CONTROL CONCEPTS

NELSON TASMAN  
**EROSION AND SEDIMENT  
CONTROL GUIDELINES**

JULY 2019





## TABLE OF CONTENTS

<b>6</b>	<b>EROSION AND SEDIMENT CONTROL CONCEPTS .....</b>	<b>1</b>
<b>6.1</b>	<b>Key principles of erosion and sediment control .....</b>	<b>1</b>
<b>6.2</b>	<b>Key Management Concepts of Erosion and Sediment Control .....</b>	<b>1</b>
6.2.1	Develop and Implement an ESCP that is capable of continuous improvement .....	2
6.2.2	Plan to minimise the extent and duration of disturbance .....	3
6.2.3	Experience and training .....	4
6.2.4	Install perimeter controls .....	4
6.2.5	Protect watercourses .....	5
6.2.6	Protect the land surface from erosion .....	5
6.2.7	Minimise sediment leaving the site .....	7
6.2.8	Stabilise all exposed areas with permanent stabilisation .....	9

### LIST OF TABLES

Table 6-1	Key Management Concepts of Erosion and Sediment Control .....	1
Table 6-3	Efficiency of erosion and sediment controls .....	7

### LIST OF FIGURES

Figure 6-1	Treatment Train Elements for Good Site Control .....	3
Figure 6-2	Perimeter Bund Leading to Sediment Retention Pond, Estuary in Background .....	4
Figure 6-3	Diversion of clean water from above the site (Goldman et al 1986 .....	5
Figure 6-4	Silt Fence Provided for Stream Protection .....	5
Figure 6-5	Good Example of Straw Mulch, Temporary Seeding and Aggregate Stone to Limit Exposed Area .....	6
Figure 6-6	Flume Installed to Protect Steep Slope .....	6
Figure 6-7	Diversion channels separating clean water from disturbed areas (Photos courtesy of BOPRC and Ridley Dunphy Environmental Limited) .....	6
Figure 6-8	Road Construction with Slope Revegetation .....	7
Figure 6-9	Sediment Control Diversion and Sediment Retention Pond .....	7
Figure 6-10	Sediment Retention Pond .....	8
Figure 6-11	Storm damage needing new management and repair .....	8

## 6 EROSION AND SEDIMENT CONTROL CONCEPTS

### 6.1 Key principles of erosion and sediment control

The first principle of erosion and sediment control is to limit erosion and sediment generation in the first instance and then to enhance deposition to retain sediment onsite.

Erosion and sediment controls have different roles.

First priority - Erosion controls to minimise any sediment from being generated and mobilised, Sediment controls capture the sediment generated and remove sediment from suspension to minimise overall sediment yield.

An Erosion and Sediment Control Plan (ESCP) should prioritise erosion control ie minimising erosion followed by control of sediment.

Solutions selected need to be appropriate for the local circumstances and will depend on the duration of earthworks and the potential yield of sediment that could discharge off-site.

Use the best tools for the site that reflect correct management of the risks for the site and activity.

### 6.2 Key Management Concepts of Erosion and Sediment Control

To ensure that erosion and sediment controls are effective and cost efficient, there are some key management concepts that should be considered throughout the project’s planning, design and construction phases and in particular when developing an ESCP:

Refer to the “Ten commandments” of Erosion and Sediment Control; see Appendix 13.4.

**Table 6-1 Key Management Concepts of Erosion and Sediment Control**

<b>Pre-Planning</b>	<ul style="list-style-type: none"> <li>• Develop and implement an evolving ESCP               <ul style="list-style-type: none"> <li>○ Determine the risks on and off site</li> <li>○ Utilise a treatment train approach</li> <li>○ Make sure the plan evolves</li> </ul> </li> </ul>
	<ul style="list-style-type: none"> <li>• Plan to minimise extent and duration of disturbance               <ul style="list-style-type: none"> <li>○ Stage and sequence construction</li> </ul> </li> </ul>
	<ul style="list-style-type: none"> <li>• Experience and Training               <ul style="list-style-type: none"> <li>○ Use suitable qualified personnel to develop and implement the ESCP</li> <li>○ Ensure all contractors understand the ESCP before their work begins</li> </ul> </li> </ul>
<b>Before work begins</b>	<ul style="list-style-type: none"> <li>• Install perimeter controls               <ul style="list-style-type: none"> <li>○ Control upper catchment water</li> <li>○ Contain all dirty water and ensure it flows to treatment device</li> </ul> </li> </ul>
	<ul style="list-style-type: none"> <li>• Protect watercourses</li> </ul>



<b>During work - Erosion Control</b>	<ul style="list-style-type: none"> <li>• Protect the land surface from erosion as much as possible             <ul style="list-style-type: none"> <li>○ Protect steep slopes</li> <li>○ Separate onsite clean water from disturbed areas</li> <li>○ Stabilise exposed areas rapidly</li> </ul> </li> </ul>
<b>During work - Sediment Control</b>	<ul style="list-style-type: none"> <li>• Minimise sediment from leaving the site             <ul style="list-style-type: none"> <li>○ Employ detention devices</li> <li>○ Assess and adjust</li> </ul> </li> </ul>
<b>Stabilise the site</b>	<ul style="list-style-type: none"> <li>• Stabilise all exposed areas with temporary or permanent stabilisation</li> </ul>

These management concepts are discussed below.

### 6.2.1 Develop and Implement an ESCP that is capable of continuous improvement

Erosion and Sediment Control Planning is more than just creating a site map of controls, it is a process. Setting aside time to consider the potential impacts of your project or activity and identifying ways of avoiding or minimising these impacts from the outset can save time, money and our environment. It is important to consider HOW you will undertake the works not just which controls you will implement, as a change to the design, sequence of works or methodology could minimise erosion and sediment generation allowing the use of simpler, less expensive and more effective controls or reduce maintenance costs (refer to Chapter 7 for information on the content of ESCPs).

#### 6.2.1.1 Determine the risks on and off site

The process for device selection and sizing as part of the ESCP should include the following aspects (refer also Appendix 13.7):

- A risk analysis to determine:
  - the potential for erosion and expected sediment yields'
  - the size, land cover and soil types of contributing catchments'
  - the sediment transport pathways on and off the site'
  - the types and sensitivity of receiving environments.
- A soils analysis (including a soil particle analysis if sediment retention ponds are considered)
- Determination of works methodologies including staging and sequencing
- Sizing of storage requirements as per Appendix 13.7
- Determination if flocculation is required.

#### 6.2.1.2 Utilise a Treatment Train approach

A treatment train comprises a series of best management practices and/or natural features, each planned to treat a different aspect of erosion and sediment control that are implemented in a linear fashion to maximise sediment removal.

Erosion and sediment control measures should generally be planned to link functionally to form a "treatment train" with each measure having a specific role within the framework of surface water management, soil protection, stabilisation, and sediment capture. This approach can be a combination of structural (e.g. sediment ponds, hydroseeding) and non-structural (e.g. seasonal timing of works) practices.

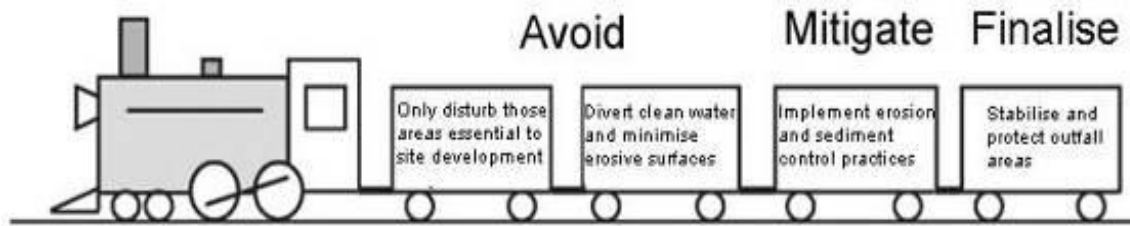

Figure 6-1 Treatment Train Elements for Good Site Control

### Key fact

**This approach needs to be considered during the early phases of project planning and followed through to the completion of the project.**

#### 6.2.1.3 Make sure the plan is subject to continuous improvement

An effective ESCP is modified as the project progresses from bulk earthworks to permanent drainage and stabilisation. Factors such as weather, changes to grade and altered drainage can all mean changes to planned erosion and sediment control practices.

Update the ESCP to suit site adjustments in time for the pre-construction meeting and initial inspection of installed erosion and sediment controls, and make sure it is regularly referred to and available on site.

### 6.2.2 Plan to minimise the extent and duration of disturbance

Fit earthworks, construction techniques and methodologies to site conditions, constraints and opportunities land sensitivity. This may be difficult depending on the development approach and where space is limited, but the concept should always be considered.

Some parts of a site should never be worked, and others need very careful working. Watch out for and, if practicable, avoid areas that are wet (streams, wetlands and springs), have steep or fragile/vulnerable soils, or are conservation or outstanding landscape sites or features.

Utilise a minimum earthworks strategy where possible and practical. Only clear areas required for structures or access. Show all limits of disturbance on the ESCP and their timing. On site, clearly show the limits of disturbance using fences, signs and flags.

#### 6.2.2.1 Stage and sequence construction

Carrying out bulk earthworks over the whole site at once maximises the extent and time that soil is exposed and prone to erosion.

"Construction staging", where the site has earthworks undertaken in small units over time with progressive revegetation, limits erosion.

For example, if a large project were to limit bare soil to 5 ha then staging would ensure that the disturbance in one area was stabilised prior to another area being disturbed. Careful planning is needed, including for aspects such as temporary stockpiles, site access and utility service installation. There are occasions when a large area is needed to be open, when this is the situation attention will be needed to ensure robust controls are in place to manage the larger scale and size.

In addition to construction staging, sequencing of construction is an important element. Sequencing sets out the order of construction to contractors and determines the order that erosion and sediment control practices are done in. For example, construction sequencing should ensure that sediment control practices are installed downslope from where the overall land disturbance is being done prior to land disturbance commencing, as well as identifying when works completion and stabilisation occurs in each area.

**Key Fact**

**Identify both, constructions staging and sequencing in the ESCP.**

**6.2.3 Experience and training**

A trained and experienced contractor is an important element of an ESCP. Contractors are individuals responsible for installing, maintaining and decommissioning erosion and sediment control practices.

Critical on-site staff should go through an erosion and sediment control training programme that may be available either locally or elsewhere in New Zealand. Better knowledge can save project time and money, by allowing for identification of threatened areas early on and putting into place correct practices. This upfront expenditure could potentially save much more in time and money by avoiding work stoppages, poor public relations, enforcement action and fines resulting from poor site controls and pollution events.

Making arrangements for a pre-construction meeting, regular inspection visits, and final inspection is also important. These meetings should be done by the developer, designer and contractor on a routine basis and there will need to be frequent interaction with Council representatives to ensure that site controls are functioning as needed and also reflect the relevant conditions of any consent.

Identify key responsibilities and appropriate personnel for each aspect of the ESCP, in particular identifying those responsible for monitoring and maintenance of devices. Also identify any training of personnel required to ensure appropriate implementation of the ESCP and onsite controls.

**Ensure all contractors on site have viewed and understand the ESCP and understand their responsibilities before their work begins.**

**6.2.4 Install perimeter controls**

Perimeter controls above the site keep clean runoff out of the worked area - a critical factor for effective erosion control. Perimeter controls can also retain or direct sediment laden runoff within the site to sediment control (detention) devices. Common perimeter controls are diversion drains, silt fences and earth bunds.

Detail the type and extent of perimeter controls in the ESCP along with the design parameters for those controls.



Figure 6-2 Perimeter Bund Leading to Sediment Retention Pond, Estuary in Background

### 6.2.4.1 Control upper catchment water

Upper catchment water is runoff from above the area of disturbance that would normally flow through the site. The key consideration in **reducing the contributing catchment** is to control this upper catchment water (clean water) and minimise the amount of water crossing exposed areas, avoiding the potential for this flow to generate sediment. This is done by controlling clean water through interception, diversion and safe disposal to a location below the area of disturbance as shown in Figure 6-3 below.

Reducing the area of the catchment contributing to just water flowing through the site will also reduce the volume of water to be treated thereby minimising the sizing of any controls, saving time, space and money.

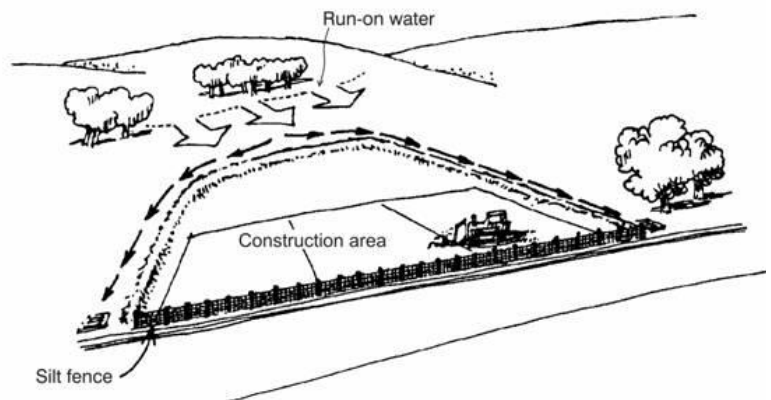

Figure 6-3 Diversion of clean water from above the site (Goldman et al 1986)

### 6.2.5 Protect watercourses

Existing streams and watercourses, and proposed drainage patterns need to be mapped and included in the ESCP. Resource consent may be required for clearance works within or adjacent to a watercourse.

Map all watercourses and show all limits of disturbance and protection measures in the ESCP. Also, the ESCP should show all practices to be used to protect new drainage channels. Indicate crossings or disturbances and associated construction methods in the ESCP.

### 6.2.6 Protect the land surface from erosion

To minimise the rates of soil loss, techniques as outlined in Chapter 8 will assist in protecting the land surface from erosion, however methods can be as simple as:

- Project design taking into account terrain limitations.
- Project scheduling to known climatic and soil variations.
- Minimising land clearance.
- Limiting areas of disturbance.
- Progressively stabilising disturbed areas (e.g. grassing and mulching).



Figure 6-4 Silt Fence Provided for Stream Protection





Figure 6-5 Good Example of Straw Mulch,  
Temporary Seeding and Aggregate Stone to Limit Exposed Area

#### 6.2.6.1 Protect steep slopes

Where possible avoid existing steep slopes. If clearing of steep slopes is necessary, runoff from above the site can be diverted away from the exposed slope to minimise erosion. If steep slopes are worked and need stabilisation, traditional vegetative covers like topsoiling and seeding may not be enough - special protection is often needed in the form of geotextile blankets, slope drains to limit vertical flow of runoff or flumes to prevent overland flow down steep slopes.

Highlight steep areas on the ESCP showing limits of disturbance and any works and areas for special protection.



Figure 6-6 Flume Installed to Protect Steep Slope

#### 6.2.6.2 Separate onsite clean water from disturbed areas

Clean water is onsite water that has not flowed through disturbed areas, whilst discharges from disturbed areas are considered to be dirty water. Diverting onsite clean water away from disturbed areas in another way of reducing the contributing catchment and minimising the volume of water that is required to be treated by sediment control devices.

Practices to achieve this include diversion channels and pipe drop structures/flumes which are outlined in Chapter 8 of this guideline.



Figure 6-7 Diversion channels separating clean water from disturbed areas (Photos courtesy of BOPRC and Ridley Dunphy Environmental Limited)

### 6.2.6.3 Stabilise exposed areas rapidly

An important objective is to fully stabilise disturbed soils with vegetation after each stage and at specific milestones within stages. Methods are site specific and can range from conventional sowing through to straw mulching (refer Chapter 8.3.3).

In the ESCP clearly define time limits for grass or mulch application, specify grass rates and species and define conditions for temporary cover in the case of severe erosion or poor germination.



Figure 6-8 Road Construction with Slope Revegetation

### 6.2.7 Minimise sediment leaving the site

It is imperative that a suite of controls are used to limit sediment discharge where earthworks or other land disturbance is occurring. Sediment controls should be selected taking into account the site constraints, the sediment transport pathways and the proximity and sensitivity of receiving environments. Steps should be taken to ensure that the controls are integrated with the permanent features of the project where appropriate. Refer to the practices outlined in Chapter 9.



Figure 6-9 Sediment Control Diversion and Sediment Retention Pond

#### 6.2.7.1 Efficiency and effectiveness of controls

The ability of an erosion and sediment control practice to prevent sediment from being generated in the first place and then transported or to remove sediment once entrained is a measure of its efficiency. This efficiency (as a %) can be represented as the volume removed by the practice measured against the volume of sediment that arrives at the practice. This percentage can be within a wide range for each method depending on site and design factors. Data is not available for all control types, however Table 6-2 provides a summary of controls for which efficiencies have been identified.

**Table 6-2 Efficiency of erosion and sediment controls**

Control Practice	Efficiency for erosion or sediment reduction
<b>Erosion control</b>	
Slope benches	49% less erosion than a uniform slope (Zhu, et al. 1999)
Hydroseeding	50-60% (Caltrans, 2002)
Mulching eg with straw	53-99% (Harding, 1990)
Placement of turf	98-99% (USEPA, 1993)
Phasing of construction	42% reduction (Claytor, 1997)
Surface roughening	18% (Dane County, 2007)



Control Practice	Efficiency for erosion or sediment reduction
<b>Sediment Control</b>	
Sediment retention pond (no chemical treatment)	50-80%
Sediment retention pond (with chemical treatment)	75-95%
Silt fence	40-75% depending on type of fabric, overflow rate and detention time (Barrett et al., 1995)
Storm drain inlet protection	No specific data available, but when filter fabric is used, performance could be similar to silt fence performance (40-75%)
Decanting earth bund	60% depending on sizing of device and rainfall intensity (NZTA 2010)

To be effective as well as efficient control practices also need to be located appropriately constructed correctly and monitored and maintained regularly.

Design of controls should also consider other factors such as the timing, cost, and sensitivity of the receiving environments.

#### 6.2.7.2 Employ sediment retention devices

Even with the best erosion control practices, land disturbance will discharge sediment laden runoff during storms. Along with erosion control measures, sediment control structures are needed to capture runoff so sediment generated can settle out. A number of different types of devices or practices, employed in a 'treatment train', may be needed to effectively manage sediment in runoff.

Include sediment retention structure design specifications; detailed inspection and maintenance schedules of structures and conversion plans for permanent structures (if this is to occur), in the ESCP.



Figure 6-10 Sediment Retention Pond

#### 6.2.7.3 Assess and adjust

Inspect, monitor and maintain control measures.

Assessment of controls is important before, during and particularly following a storm. Before the storm to check all is in order, during to see if the actual design is performing to the specifications and after to see if any repairs are needed.

A large or intense storm may leave erosion and sediment controls in need of repair, reinforcement or cleaning out. Repairing without delay reduces further soil loss and environmental damage.



Figure 6-11 Storm damage needing new management and repair

Assessment and adjustment is an important erosion and sediment control practice -make sure it figures prominently in the ESCP and ensure contractors are aware of their responsibilities. Assign responsibility for implementing the ESCP and monitoring control measures as the project progresses.

**It is not enough to just have controls in place on site it is also essential that the controls work for the duration of the project.**

### **6.2.8 Stabilise all exposed areas with permanent stabilisation**

Sites are considered permanently stabilised when all exposed soils are covered and protected from raindrop impact and erosion from overland flows, in a way that will provide ongoing protection over the long term. This includes sealing with concrete, asphalt or aggregate, use of geotextiles designed for long-term use and growth of self-sustaining vegetation (including exotic or native grasses, ground covers, shrubs and trees).

Self-sustaining vegetation means not requiring ongoing intense maintenance or watering, past the initial establishment phase, to ensure ongoing survival of at least 80% ground coverage. If this is unlikely to be achievable due to site constraints, some other method of permanent stabilisation may be more appropriate.

It is important to consider the steepness and aspect of batter slopes, soil moisture, topsoil and nutrient needs and the plant species used, to ensure the plants selected can cope with the specific site conditions over the long term, particularly with hot dry summers and harsh sun of the region.

## Chapter 7

# DEVELOPING AN EROSION AND SEDIMENT CONTROL PLAN

NELSON TASMAN  
**EROSION AND SEDIMENT  
CONTROL GUIDELINES**

JULY 2019





## TABLE OF CONTENTS

<b>7</b>	<b>DEVELOPING AN EROSION AND SEDIMENT CONTROL PLAN .....</b>	<b>1</b>
<b>7.1</b>	<b>When is an Erosion and Sediment Control Plan required?.....</b>	<b>1</b>
<b>7.2</b>	<b>Site Plan Contents .....</b>	<b>2</b>
<b>7.3</b>	<b>Methodology Contents .....</b>	<b>3</b>
7.3.1	Project description .....	3
7.3.2	Estimate of sediment loss.....	3
7.3.3	Principles to minimise erosion and sediment discharge from the site .....	3
7.3.4	Design of erosion and sediment control devices.....	4
7.3.5	Timetable and nature of site stabilisation .....	4
7.3.6	Maintenance, monitoring and reporting procedures.....	4
7.3.7	Heavy rainfall response and contingency measures.....	4
7.3.8	Procedures for review and/or amendment to the E&SCP .....	4
7.3.9	Identification of specific site responsibilities .....	4
7.3.10	Construction timetable.....	5
<b>7.4</b>	<b>Implementation of the ESCP.....</b>	<b>5</b>

### LIST OF TABLES

Table 7-1	ESCP – Site Plan Contents Checklist.....	2
-----------	--	---

### LIST OF FIGURES

Figure 7-1	Erosion and Sediment Control Planning Process.....	6
------------	--	---



## 7 DEVELOPING AN EROSION AND SEDIMENT CONTROL PLAN

An Erosion and Sediment Control Plan (ESCP) should exist for all sites undertaking earthworks. The plan identifies the measures that will be implemented to minimise erosion and subsequent sediment yield from a site as a result of land disturbing activities. It has two parts, a written methodology and a site plan which can be combined into one document.

The written methodology contains information on various aspects of the project and proposed erosion and sediment controls. The site plan provides a visual understanding of the layout of what the site looks like and includes details such as the location of control devices and other relevant features.

### 7.1 When is an Erosion and Sediment Control Plan required?

Tasman District Council is encouraging all land disturbance sites to have an ESCP as a matter of best practice irrespective of the scale of the works and whether or not a resource consent is required. The scale of the plan should reflect the scale of the land disturbance and the risk of erosion and sedimentation (ie small site low risk = basic ESCP large site high risk = comprehensive ESCP). Erosion and sediment control and an ESCP are expected to be incorporated into the building consent process and building site management.

Draft ESCPs are generally required by Tasman District Council to support all resource consent applications for earthworks and land disturbing activities. Once consents have been granted a revision of the draft ESCP is normally required to take account of contractor input, design changes or specific consent requirements, prior to formal approval of the ESCP by Tasman District Council.

Land disturbance activities that do not require resource consents (ie Permitted Activities) should also have an ESCP, with the level of detail required appropriate to the nature of the site, the works proposed and the risk of erosion and sediment generation.

Developing an ESCP is one method of demonstrating compliance with the Permitted Activity rules of the respective Council Plans. If Permitted Activity standards cannot be complied with then a resource consent is required.

This guideline document should generally be used as a minimum standard for developing ESCPs. In some cases, the standards set out in these guidelines will need to be exceeded or adapted to reflect best practice for a particular site. For example, sites with sensitive watercourses, steep slopes and/or high clay content soils may need to have sediment retention devices with increased treatment capacities with flocculation treatment systems.

Chapter 6 outlines the key concepts and principles to follow in considering erosion and sediment controls on your site when developing your ESCP. Chapters 7.2 and 6.3 outline the contents required in a site plan and methodology. While these sections focus on development earthworks, they can be modified to suit any land disturbance activity.

Persons developing ESCPs should have appropriate experience or be appropriately qualified, particularly where these are developed for more complex sites, requiring more comprehensive plans.

A comprehensive plan will also allow contractors to adequately cost erosion and sediment control aspects of a job.

## 7.2 Site Plan Contents

The site plan should provide a clear picture of the layout of the site, the erosion and sediment controls and any other relevant features. It is also useful to provide a second site (or on the same plan) plan showing the site topography and water drainage flow paths after re-contouring.

The Erosion and Sediment Control Plan should contain the information listed in Table 7-1 to a degree reflective of the size and potential risk of erosion and sediment transport of the project.

For small scale projects this may be shown on a single plan (refer to the Small Site Erosion and Sediment Control Guide), however larger more complex projects may require several plans to clearly show information. These might include a site plan, earthworks plan, erosion and sediment device plan, staging plans and design plans as required to effectively illustrate the evolution of the ESCP. Additional maps can also be used to provide a greater level of detail in high erosion risk or environmentally sensitive areas.

Standard symbols should be used on all ESCP maps. The symbols for E&SC devices are found in Appendix 13.2 and should be used for the site plan. If additional symbols are required a legend should be clearly provided on the plan detailing these.

Table 7-1 ESCP – Site Plan Contents Checklist

<b>1</b>	<b>GENERAL</b>
2	Plan Title: "Erosion and Sediment Control Plan"
3	Plan Date
4	Plan/Drawing Reference Number
5	North Arrow and Scale
6	Site Physical Address (street address, appellation or title etc) <b>and GPS Coordinates</b>
7	Legend
<b>8</b>	<b>SITE INFORMATION</b>
9	Site boundaries
10	Site entrances
11	Existing Contour lines with elevation labels
12	All watercourses and / or overland flow paths
13	All stormwater or sewer pipes which could act as sediment transport pathways
14	Catchment boundaries
15	Historical and cultural sites
16	Areas of high erosion risk (steep slopes or vulnerable geologies)
17	Vegetation and natural features
<b>18</b>	<b>EARTHWORKS INFORMATION</b>
19	Extent of soil disturbance (earthworks footprint)
20	Clearly marked areas of cut and fill and future contours
21	Areas of distinct work stages
22	Drainage lines and future reticulation
23	Identification of 'no-go' or buffer areas to be maintained on site
24	Location and extent of topsoil and material stockpiles
<b>25</b>	<b>EROSION AND SEDIMENT CONTROL INFORMATION</b>
26	Location of E&SC devices
27	Unique identification numbers for each erosion and sediment control structure
28	Extent and area (in m <sup>2</sup> or ha) of contributing catchments for each E&SC device
29	Arrows depicting the general flow path and direction of water within each contributing catchment
30	Areas to be temporarily stabilised (and type of stabilisation to be used)
31	Any monitoring sites for assessing discharge quality or device performance
<b>32</b>	<b>Any other relevant site information</b>

### 7.3 Methodology Contents

For small, short duration, low erosion risk sites, a basic methodology can be provided. This could be confined to an explanation about the site characteristics and aspects of works that limit site risks.

For sites with increasing risk of erosion and sediment yield a proportional increase in information will be required.

The methodology should contain:

- Project description
- Estimate of sediment loss (USLE)
- Principles to minimize erosion and sediment discharge from the site
- Design of erosion and sediment control devices
- Timetable and nature of site stabilisation
- Maintenance, monitoring and reporting procedures
- Heavy rainfall response and contingency measures
- Procedures for review and/or amendment to the ESCP
- Identification of specific site responsibilities
- Construction timetable.

#### 7.3.1 Project description

Provide a description of the project, which should include information such as disturbed soil volumes, area of disturbance, and purpose for the works. The various construction components should be identified along with the sequence of events that will occur to complete the project from start to finish (eg construction staging and sequencing). A description of the existing site, including vegetation, topography, watercourses and other relevant matters, should also be included.

#### 7.3.2 Estimate of sediment loss

A Universal Soil Loss Equation (USLE) should be used to estimate sediment yield from the site, especially for steep sites or sites with sensitive receiving environments. USLE will also serve the purpose of identification of higher sediment generation areas on the site and hence enable a focused approach to those areas of concern. Refer to Appendix 13.6 for USLE method and calculation

A brief analysis of the results of the USLE should be provided. This should include comment on the expected level of soil loss and any ‘hot spots’ where higher volumes of soil loss have been identified on the site (eg steep slopes). The results of the USLE should be considered along with the sensitivity of the receiving areas to provide rationale for the proposed E&SC measures.

#### 7.3.3 Principles to minimise erosion and sediment discharge from the site

Principles for E&SC that will be applied to the project should be identified. It is recommended that plan developers become familiar with the underlying principles of erosion and sediment control contained within Chapter 6 and incorporate these into their ESCP.

#### **7.3.4 Design of erosion and sediment control devices**

Each catchment on the site should be separately listed and the E&SC devices within that catchment should be specified, and uniquely identified. Detailed design information for each E&SC device should be provided including the contributing catchment size for each device.

Design information should include aspects such as holding capacity and dimensions of E&SC devices, as well as details of associated parts of the devices such as decant outlets and emergency spillways. Annotated drawings of proposed E&SC devices should be provided. Supporting calculations for E&SC device design should also be included where relevant. “As-builts” may be required for key E&SC structures such as sediment retention ponds.

#### **7.3.5 Timetable and nature of site stabilisation**

Include timeframes and methods for achieving stabilisation of all disturbed areas. Proposed re-vegetation techniques should be identified, as well as instances where instant stabilisation methods will be used. Grass seed and fertiliser application details, including application rates should be specified. When planning site stabilisation, particular attention should be given to achieving stabilisation of all or most of the site prior to any shut down period. This is particularly relevant to steeper areas of the site or other areas which have been identified as ‘hot spots’ in a USLE.

#### **7.3.6 Maintenance, monitoring and reporting procedures**

Set out the regime for routine monitoring of the E&SC. Details should include the frequency of inspections, procedures for recording and reporting monitoring results, and the role description and qualifications of the personnel undertaking the monitoring. Site rehabilitation works and trigger levels for removing sediment from E&SC should be provided.

#### **7.3.7 Heavy rainfall response and contingency measures**

Information should include actions that will be taken in the event of heavy rainfall (to be defined). This could include aspects such as monitoring weather forecasts and undertaking additional inspections in the event of heavy rain warnings. Any additional control measures proposed in the case of heavy rain warnings should be identified here. For large or long duration sites consideration should be given to installing a rain gauge onsite and recording daily rainfalls to determine when any rainfall related trigger levels have been exceeded (eg discharge sampling requirements) and for assessing the effectiveness of the E&SC proposed. Contingency measures in the event of failure of any E&SC device should be identified.

#### **7.3.8 Procedures for review and/or amendment to the E&SCP**

An ESCP should be considered a “living document.” It is expected that amendments to the plan will be required as site construction proceeds.

Set out procedures for reviewing and amending the ESCP. Review procedures should include consultation with Tasman District Council as amendments to the plan will usually require Tasman District Council’s written approval.

#### **7.3.9 Identification of specific site responsibilities**

Identify the relevant personnel and chain of command for ensuring that the various aspects of the ESCP are implemented. This may include aspects such as routine monitoring and maintenance, provision of design details for E&SC devices, and ensuring that E&SC devices have been constructed correctly.

### 7.3.10 Construction timetable

Include the sequence and timing for construction of the E&SC and bulk earthworks. The length of time that the construction works will take should be specified.

## 7.4 Implementation of the ESCP

It is good practice to include detailed draft ESCPs (or if available, approved ESCPs) with contract documents. This assists contractors in understanding Council requirements and their responsibilities, as well as assisting with accurate pricing of works required to implement the ESCP.

ESCPs are generally prepared by engineers/consultants and implemented by contractors under the supervision of the engineer/consultants. Good communication between all parties during plan preparation will often result in a much improved ESCP and aid its subsequent implementation.

**Ensure all contractors on site have viewed and understand and have had necessary input into the ESCP before their work begins.**



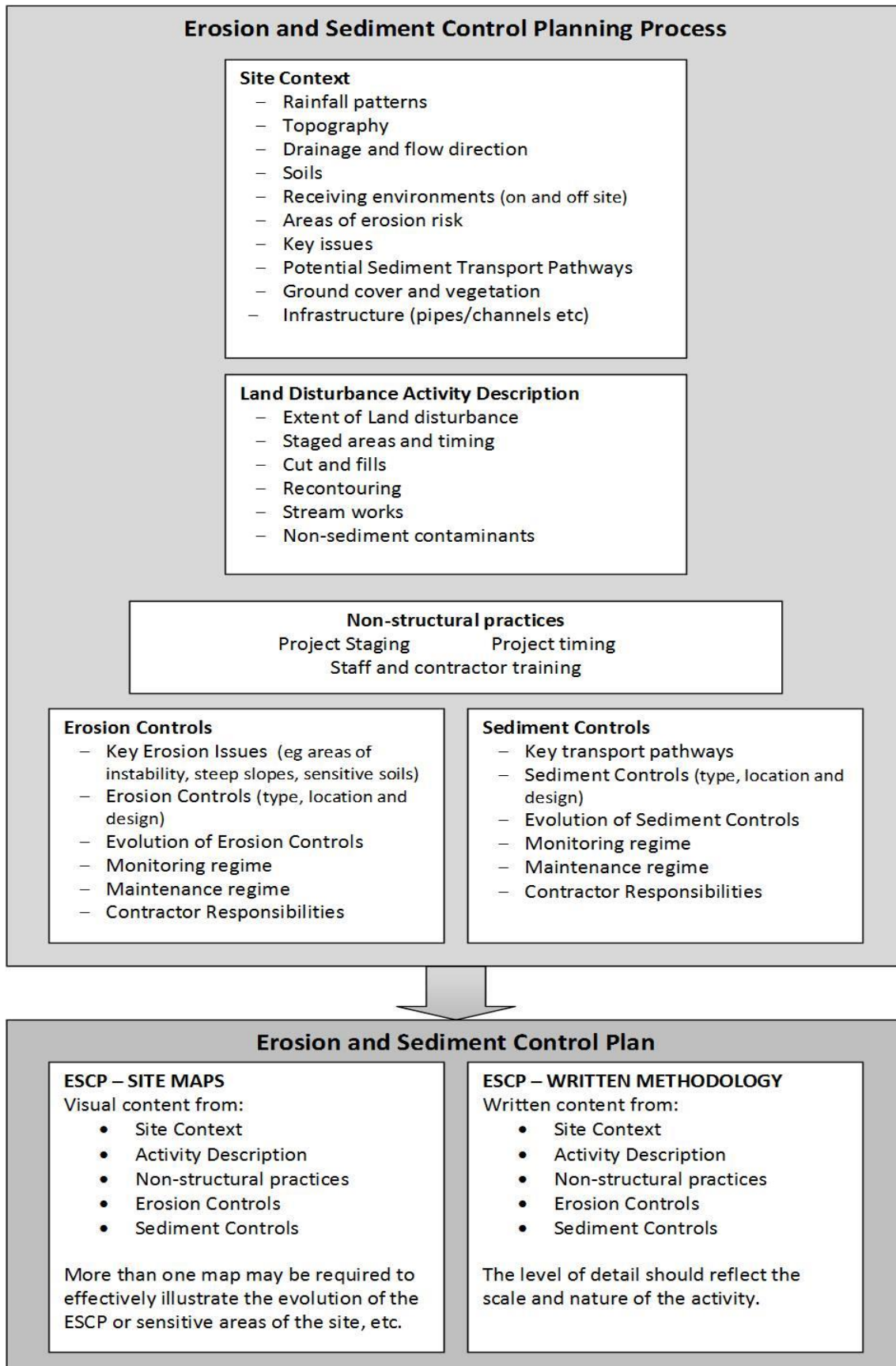

Figure 7-1 Erosion and Sediment Control Planning Process

# Chapter 8

## Erosion Control Practices

NELSON TASMAN  
**EROSION AND SEDIMENT  
CONTROL GUIDELINES**

JULY 2019





## TABLE OF CONTENTS

<b>8</b>	<b>EROSION CONTROL PRACTICES</b> .....	<b>1</b>
<b>8.1</b>	<b>Introduction</b> .....	<b>1</b>
<b>8.2</b>	<b>Water Management Controls</b> .....	<b>1</b>
8.2.1	Check dams.....	2
8.2.2	Temporary Contour Drains (Cut-Offs) .....	5
8.2.3	Diversion Channels .....	8
8.2.4	Pipe Drop Structures and Flumes .....	14
8.2.5	Surface Roughening.....	17
8.2.6	Benched Slopes .....	19
8.2.7	Stabilised Entranceways .....	22
<b>8.3</b>	<b>Soil Stabilisation Practices</b> .....	<b>25</b>
8.3.1	Topsoiling and Grass Seeding .....	26
8.3.2	Hydroseeding.....	31
8.3.3	Mulching .....	33
8.3.4	Turfing.....	36
8.3.5	Geotextiles and erosion control blankets .....	38
8.3.6	Dust control.....	42

### LIST OF TABLES

Table 8-1	Erosion Controls.....	1
Table 8-2	Positioning of check dams .....	3
Table 8-3	Contour Drain Spacing.....	7
Table 8-4	Mannings roughness coefficient for a range of materials .....	10
Table 8-5	Sizing criteria for pipe drop structure .....	15
Table 8-6	Sizing criteria for flumes.....	16
Table 8-7	Benched slope spacings .....	20
Table 8-8	Stabilised entranceway specifications .....	23
Table 8-9	Typical seed and fertiliser application rates .....	29

### LIST OF FIGURES

Figure 8-1	Check dams installed in series to act as a water velocity control measure.....	2
Figure 8-2	Fabric filled check dams in conjunction with erosion control matting. Note flow evidence over the centre portion of the dams .....	3
Figure 8-3	Rock check dams (Figure: Auckland Council) .....	4
Figure 8-4	Contour drains illustration (Figure: BOPRC).....	5
Figure 8-5	Contour drains established on embankments as a water control measure in conjunction with progressive stabilisation.....	6
Figure 8-6	Contour drain intercepting slope runoff. Note straw mulch to reduce raindrop impact.....	6
Figure 8-7	Contour Drain Detail (Note the heights are indicative only).....	7
Figure 8-8	Diversions for intercepting clean water (left) and dirty runoff (Photos courtesy of BOPRC and Ridley Dunphy Environmental Limited).....	8
Figure 8-9	Area and hydraulic radius calculations for parabolic and trapezoidal profiles .....	11

Figure 8-10	Cross section of clean water diversion .....	11
Figure 8-11	Cross section of dirty water diversion .....	12
Figure 8-12	Pipe drop structure (note check dams, silt fence and channel protection also) .....	14
Figure 8-13	Flume to a sediment retention pond .....	14
Figure 8-14	Wooden flume lined with impervious material .....	15
Figure 8-15	Flume and pipe drop structure design. (Figure: Auckland Councils') .....	16
Figure 8-16	Surface roughening with a bulldozer.....	17
Figure 8-17	Slope roughening in conjunction with stabilisation .....	18
Figure 8-18	Slope roughening in conjunction with stabilisation .....	<b>Error! Bookmark not defined.</b>
Figure 8-19	Benched Slope.....	20
Figure 8-20	Benched Slope with Reverse Benches.....	20
Figure 8-21	Stabilised Entranceways.....	22
Figure 8-22	Example of a shaker ramp in site access point .....	23
Figure 8-23	Stabilised construction entrance showing progression of construction with filter fabric underlay prior to stone placement.....	24
Figure 8-24	Stabilised construction entrance	
Figure 8-25	Vegetative stabilisation is an effective erosion control practice.....	26
Figure 8-26	Grass strike densities - percent coverage .....	27
Figure 8-27	Hydroseed being applied to a vertical face and the eventual stabilisation (photos courtesy of Erosion Control Ltd). .....	31
Figure 8-28	Recently applied hydroseed showing emergent grass growth .....	32
Figure 8-29	Application of straw mulch as a temporary ground cover .....	33
Figure 8-30	Recently applied mulch (Photo courtesy of BOPRC) .....	33
Figure 8-31	Straw mulch being crimped into ground to reduce windblown potential.....	35
Figure 8-32	Well applied mulch and vegetative cover (photo courtesy of BOPRC and Ridley Dunphy Environmental Ltd).....	35
Figure 8-33	Turf being applied to provide immediate ground cover .....	36
Figure 8-34	Turf being applied for a swale outfall .....	36
Figure 8-35	Erosion control blanket for slope protection. Notice grass growing through blanket.....	38
Figure 8-36	Plastic cover to prevent slope erosion .....	39
Figure 8-37	Plastic cover providing slope protection with plantings placed throughout the cover.....	40
Figure 8-38	Geotextile Design on slopes (figure courtesy of Auckland Councils') .....	40
Figure 8-39	Geotextile Design on outfalls (figure courtesy of Auckland Councils') .....	41
Figure 8-40	Dust suppression by water sprinkling .....	42



## 8 EROSION CONTROL PRACTICES

### 8.1 Introduction

This section considers erosion control from two aspects:

1. **Water Management:** controlling the volume and rate of water runoff from within and around the land disturbance area; and
2. **Stabilisation:** Providing a protective cover against sediment generation and transportation

In any land disturbance site, both of these types of practices will most likely be required. However, the choice of which erosion control measure is to be used will depend on the specific site constraints and the project construction sequencing.

The erosion controls outlined in this section are summarised in the table below:

Table 8-1 Erosion Controls

		Page Ref
<b>Water Management Controls</b>	Check Dams	2
	Contour drains (Cut-offs)	5
	Diversion channels and bunds	8
	Pipe Drop Structures and Flumes	14
	Surface Roughening	17
	Benched Slopes	19
<b>Stabilisation Methods</b>	Stabilised Entranceways	22
	Topsoiling and grass seeding	26
	Hydroseeding	31
	Mulching	33
	Turfing	36
	Geotextiles, plastic covers and erosion control blankets	38
	Dust Control	42

### 8.2 Water Management Controls

Control of site runoff is one of the most important erosion control measures that can be done in your works area. These practices help to reduce water velocities, which in turn reduce erosion, and provide some reduction in contributing catchments requiring treatment with the overall aim of minimising sediment generation. The key philosophy is keeping offsite (clean) water clean and away from disturbed areas, keeping velocities low and diverting sediment laden (dirty) water to sediment retention devices.

Check dams, contour drains, diversion channel/bunds, pipe drop structures, surface roughening and benched slopes are all examples of common measures to control water and runoff on land disturbance sites. These practices are discussed in subsections 8.21 to 8.26.

## 8.2.1 Check dams

### 8.2.1.1 Definition and purpose

Check dams are small dams made of rock riprap or other non-erodible material constructed across a swale or channel to act as grade control structures. They are usually placed in series down the channel and used during construction.

The purpose of check dams is to:

- Reduce the velocity of concentrated flows, and
- Reduce invert scour in drains or channels that will be reworked, filled, grassed or otherwise stabilised.

Check dams are not intended to be sediment trapping practices and the dams work by temporarily ponding the water and then slowly releasing the impounded water at a more controlled rate having lower velocities. Some sediment will however be trapped behind these check dams and as such will require ongoing maintenance.



### 8.2.1.2 Conditions where practice applies

Check dams may be:

- Placed within temporary swales or channels, which because of their temporary nature may not be suitable for a non-erodible lining (e.g. geotextile) but still need some protection to reduce erosion.
- Placed in either temporary or permanent swales/channels which need protection during the establishment of vegetative cover.



### 8.2.1.3 Limitations

Check dams have the following limitations:

- The contributing catchments for a complete series of check dams should not exceed 1ha for slopes less than 10%. With contributing catchments greater than this area, specific engineering design using the methodology in Appendix 13.8 should be done.
- They may not be an effective practice on steep slopes as they will need to be very closely spaced to achieve design criteria.
- They are not recommended for use in watercourses with perennial flow.
- They have a primary purpose of a water control measure only – they are not intended for sediment trapping purposes.
- Channels will erode if the dams are spaced too far apart (especially on highly erodible soils).
- Check dams can be time consuming to construct, especially on steep slopes where a greater frequency of dams per unit length is required.

Figure 8-1 Check dams installed in series to act as a water velocity control measure

- They may not be a suitable option to provide erosion protection when highly erodible soils are prevalent.

#### 8.2.1.4 Key design criteria

Temporary check dams are typically constructed of loose rock (riprap) or sandbags. Prefabricated and re-useable triangular plastic material is also available, and reinforced fabric dams can also be used. However, it is critical that they are constructed of competent material and do not erode themselves.

The check dams can either be constructed with a 450mm centre height or a 600mm centre height and the following table is to be used to determine the spacing of check dams for channel slopes within indicated ranges.



Figure 8-2 Fabric filled check dams in conjunction with erosion control matting. Note flow evidence over the centre portion of the dams

Spacing for check dams are outlined in Table 8-2.

Table 8-2 Positioning of check dams

Slope of site (%)	Spacing (m) between dams with a 450mm centre height	Spacing (m) between dams with a 600mm centre height
Less than 2%	24	30
2 – 4%	12	15
4 – 7%	8	11
7 – 10%	5	6
>10%	Unsuitable – use stabilised channel or specific engineered design	Unsuitable – use stabilised channel or specific engineered design

- The maximum height of a check dam depends on the depth of the drain into which it is being placed. As a general rule the centre height (spillway level) should be no higher than 600mm.
- Incorporate a spillway into the design of check dams to direct flows over the centre of the structure with the spillway elevation at least 150mm to 200mm lower than the crest of the structure.
- To be effective, place check dams so that the toe of the upstream dam is at the same elevation as the crest of the downstream dam. The standard detail of check dams is shown in Figure 8-1.
- When used on highly erodible soils, check dams should be placed on a needle-punched geotextile fabric to minimise the chance of water undermining the structure.

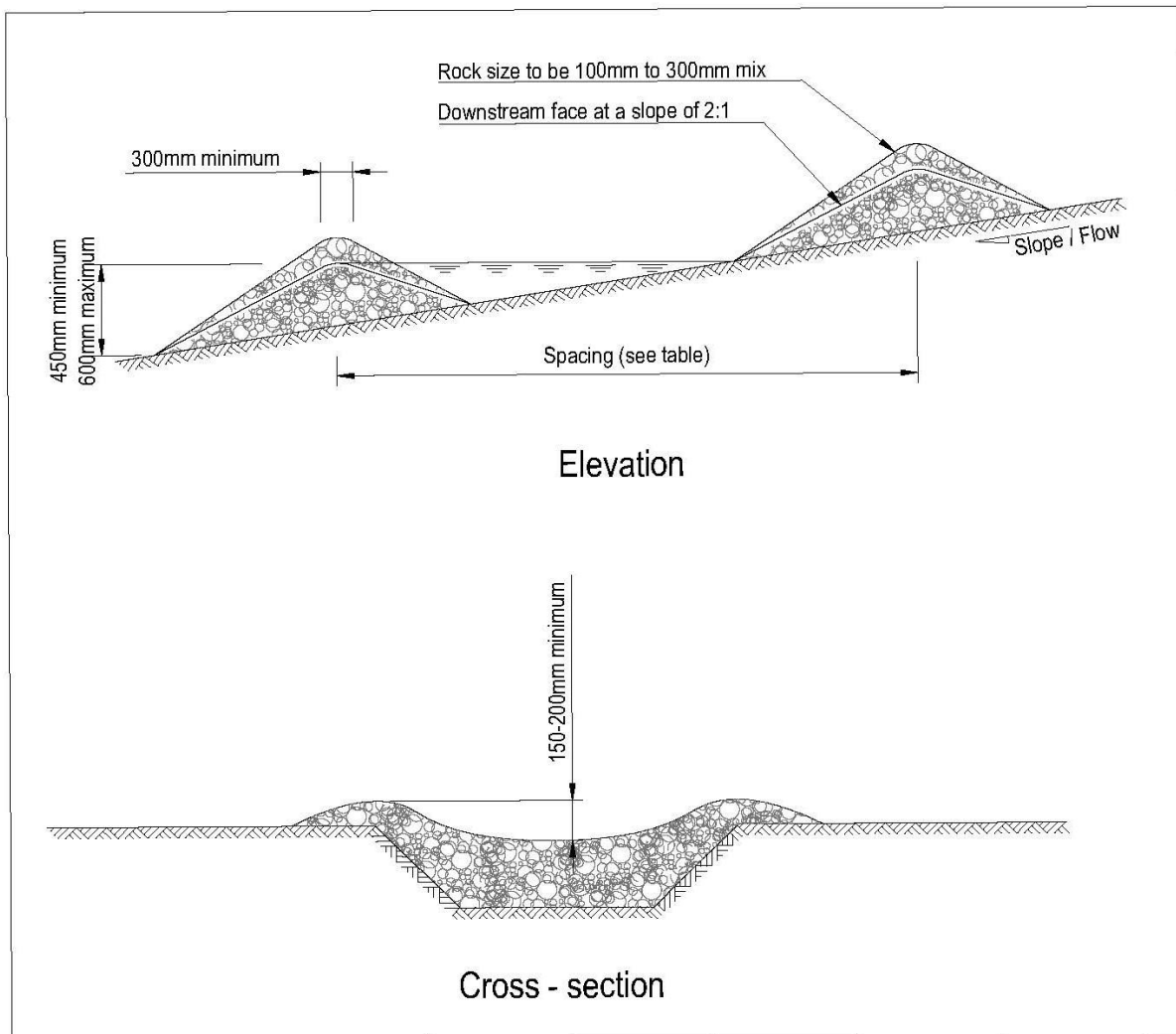

Figure 8-3 Rock check dams (Figure: Auckland Council)

#### 8.2.1.5 Maintenance

Key items to check as part of the regular inspection includes:

- Repair or reinstate the check dams if destroyed by machinery movement.
- Inspect the check dams after rainfall or storms and repair as necessary.
- Check if water is outflanking the structure and look for scouring around the edges of the check dam: if so – increase the spillway depth, crest height and/or turn up edges of structure.
- If scour is occurring between check dams, then additional structures may need to be provided.
- Check dams should be inspected for sediment accumulation after each significant rain event. Sediment should be removed when it reaches 40% of the original height or before this occurs.
- Dispose of removed sediment to a secure area to ensure that it does not discharge to the receiving environment.

#### 8.2.1.6 Decommissioning

In decommissioning check dams consider the following:



- Remove check dams when no longer needed, and where possible salvage all materials for re-use in future check dams or other works.
- Do not remove check dams that are protecting grass-lined channels until a complete and sustainable cover has been achieved.
- Fertilise and protect disturbed areas with surface mulch or erosion control matting if required.

## 8.2.2 Temporary Contour Drains (Cut-Offs)

### 8.2.2.1 Definition and purpose

Contour drains are temporary excavated channels or ridges or a combination of both, which are constructed slightly off the slope contour.

The purpose of a contour drain is to:

- Break overland flow draining down disturbed slopes by reducing slope length and thus the erosive power of runoff.
- To divert sediment laden water to appropriate controls via stable outlets. Note that they do not form the same function as a Dirty Water Diversion Bund as they are more of a temporary feature.

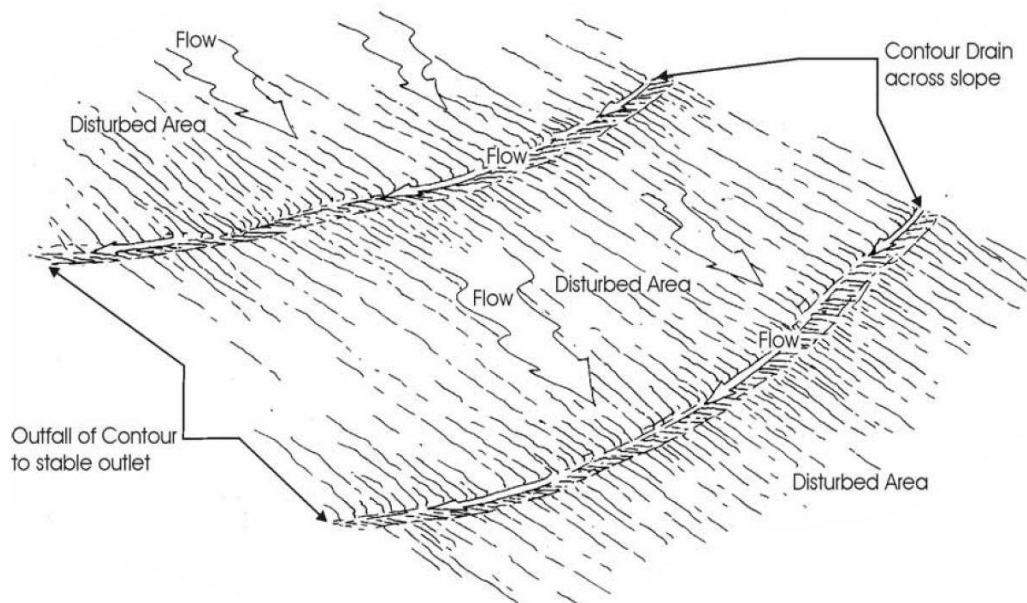

Figure 8-4 Contour drains illustration (Figure: BOPRC)

Use as mid-slope contour banks and/or drains over the short-term. Temporary contour drain structures should be placed across unprotected slopes within the working area at the end of each day's work, before site closedown or when rain is imminent.

### 8.2.2.2 Conditions where practice applies

The practice of using contour drains should be promoted on all earthwork's sites, especially where there are large areas of exposed ground and long steep slopes. The specific scenarios for their application include the following:

- To segment slopes so that the water flows on these slopes are reduced, limiting the erosion potential of the water. They should be used at mid to lower slopes on all exposed areas.

- To assist with the diversion of dirty water flows towards sediment retention devices (e.g. sediment retention pond, decanting earth bund). Note that they do not form the same function as a Dirty Water Diversion Bund as they are more of a temporary feature.
- To use as cut-offs on tracking activities to direct water into a stable water table and/or outfall structure.

### 8.2.2.3 Limitations

Contour drains have the following limitations:

- Contour drains will concentrate sheet flows, thereby can increase erosion potential. This is of most concern on any steep slope and in any vulnerable soils such as uncompacted fills and weak soils.
- They may not be an effective practice on very steep slopes (>30%) as they will need to be very closely spaced to achieve performance characteristics.
- Unless the right sizing and spacing of drains is utilised, they have the potential to overtop during high intensity rainfall events.
- Steep contour drains longitudinal grades (> 2%) will increase flow velocities and may promote erosion. In these circumstances' drains will need to be lined to prevent scouring within the channel invert.
- Excessively flat contour drains grades mean sediment deposition is likely to occur, reducing capacity and potentially resulting in overtopping of the structure.

Due to their temporary nature, they may be a “weak link” in the overall treatment train by being installed too late or not sized/spaced appropriately.

### 8.2.2.4 Key design criteria

Formal design of the contour drains is generally not required due to their temporary nature. Although commonly called contour drains, this term is misleading as they need to be constructed slightly off the contour (max grade 2%) to ensure they drain appropriately.

The following design principles are critical to their effectiveness as an erosion control practice:

- Minimum compacted bank height of 250mm.
- Minimum depth of 500mm.
- Longitudinal gradients not to exceed 2% (otherwise lining may be required).
- Be broad enough to create a low-profile bank so that large earth working machinery can safely cross. If this is not achievable, a dedicated crossing using a temporary culvert can be used.
- Avoid construction with a “V” profile instead use a trapezoidal shape.
- Outlets need to be carefully positioned to minimise erosion and may need to be lined with geotextile or other suitable material



Figure 8-5 Contour drains established on embankments as a water control measure in conjunction with progressive stabilisation.



Figure 8-6 Contour drain intercepting slope runoff. Note straw mulch to reduce raindrop impact



Indicative maximum catchment slope lengths are provided in Table 8-3 below.

Table 8-3 Contour Drain Spacing

Slope of site (%)	Spacing (m) of contour drains
Less than 5%	50
5 – 10%	40
10 – 15%	30
15 - 30%	20

Specifications for contour drains are outlined in Figure 8-7.

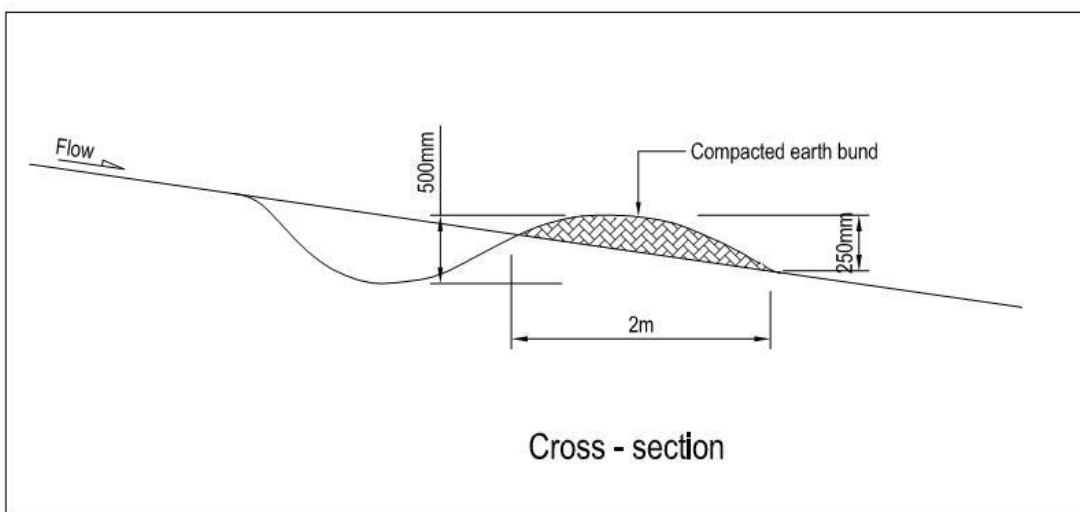

Figure 8-7 Contour Drain Detail (Note the heights are indicative only)

#### 8.2.2.5 Maintenance

Key items to check as part of the regular inspection includes:

- Repair or reinstate contour drains if destroyed by machinery movement.
- Inspect contour drains after rainfall or storms and repair as necessary.
- Check the outfall for erosion and repair if required. It may be necessary to install a temporary flume or provide geotextile.
- Use sandbags during rainfall events if extra height is needed on the ridges of contour drains.

#### 8.2.2.6 Decommissioning

Contour drains are typically removed after the rainfall event as part of the general earthworks' activity.

### 8.2.3 Diversion Channels

#### 8.2.3.1 Definition and purpose

Diversion channels are channels and/or bunds used to convey either clean water to stable outlets or dirty runoff to sediment retention devices. They are constructed for a specific design storm.

For dirty water runoff, diversions are used to collect and convey sediment-laden water within the disturbed area, or inside the perimeter, to an appropriate sediment retention device for treatment.

For clean water runoff, diversions are used to intercept and divert offsite (clean) water away from the works area. This minimises erosion by reducing the volume of water flowing over the site and reduces the amount of water than requires treatment, allowing for more effective sediment control devices.



Figure 8-8 Diversions for intercepting clean water (left) and dirty runoff (Photos courtesy of BOPRC and Ridley Dunphy Environmental Limited)

Clean Water Diversion Channels may be installed as permanent drainage works, but as a minimum are installed throughout the duration of the earthworks programme. Permanent measures will require channel invert and bank stabilisation to be installed.

Diversion of clean water is typically diversion of overland flow from either upper catchments or from undisturbed areas on site. In some cases diversion of ephemeral streams may be required which needs additional consideration of environmental effects and compliance with rules within the TRMP and NRMP for works in watercourses - refer Chapter 10 for further detail. Diversion of intermittent or perennial streams is also covered separately in Chapter 10. Diversion of watercourses may require resource consent.

#### 8.2.3.2 Conditions where practice applies

Diversion channels are predominately used in the following situations:

- To divert clean runoff water above the works site and divert to stable outlet(s).
- As a physical “perimeter boundary” of an earthworks activity site to isolate the site and prevent sediment from leaving the area.
- To divert sediment-laden water to an appropriate sediment retention device (e.g. sediment retention pond or decanting earth bund).

#### 8.2.3.3 Limitations

Clean water and dirty water diversions have the following limitations:

- They should not be confused with temporary contour drains and therefore need to be specifically sized and constructed for the site conditions.
- In contributing catchments greater than 2ha, specific engineering design (sizing, shape and outfall) will be required for dirty water diversions based on the risk profile outlined in Appendix 13.7 and specifications in Section 8.2.3.4.
- Specific engineering design (sizing, shape and outfall) will be required in all cases for clean water diversions based on the risk profile outlined in Appendix 13.7 and specifications in Section 8.2.3.4.

- In some examples (e.g. steep slopes and/or unstable ground), specific geotechnical design will be required to avoid failure of the structure.
- It is often difficult to construct a bund or channel with the required channel capacity on steep slopes. Consider all options and in particular the location of the sediment retention device to which the dirty water diversion will flow into.
- Access for maintenance can be difficult once construction has commenced.

#### 8.2.3.4 Key design criteria

Diversion channels are typically constructed across a slope. This requires a bund on the downslope side to prevent flow from spilling out of the channel. Diversions may take the form of catch drains (usually lined with an erosion-resistant material such as needle-punched fabric), existing or new stormwater reticulation systems, combination bank or bund with excavated upslope channel, or earthen bank (often made from compacted topsoil).

There are many designs for diversions; however, the following key aspects are required:

**Sequencing:** Always construct clean water diversion channels prior to undertaking any other earthworks.

**Location:** Diversion locations are to be determined by considering outlet conditions, topography, land use, soil type, length of slope, seep planes (when seepage is an issue) and the development layout. Where practicable, choose a route for permanent structures that avoids trees, existing or proposed service infrastructure, existing or proposed fence lines and other natural or built features.

**Stability of Structure:** Ensure the bunds associated with the diversion channels are well compacted, and stabilised. In some instances, this may require specific geotechnical design to ensure the stability and integrity of the structure.

Consider where excess runoff will drain to, if the design storm is exceeded and the diversion channel is overtopped. Consider designing an emergency overflow section or bypass area, in the most appropriate location, to limit damage from storms that exceed the design storm.

**Capacity:** The minimum capacity required is:

- For dirty water diversions – the same capacity equivalent to the design storm sizing used for the sediment control device it discharges into (eg a 20yr ARI sediment retention pond should have 20yr ARI capacity diversions), plus a 10% freeboard
- For clean water diversions – capacity as defined by the risk profile for receiving environment sensitivity, as given in Appendix 13.7, plus a 10% freeboard.

Diversion channels methodology:

1. Determine the peak discharge (in m<sup>3</sup>/s) for the area that drains into the channel using the approach outlined in Appendix 13.7 (with storm frequency determined by either: the downstream sediment control device sizing in the case of dirty water diversions; or the sensitivity of the receiving environment for clean water diversions).

2. Calculate the capacity of the diversion channel/bund using the following formula:

$$Q = A R^{2/3} S^{1/2}$$

where

Q = Discharge (m<sup>3</sup>/s)

A = Cross Sectional Area (m<sup>2</sup>) (refer Figure 8-9)

R = Hydraulic Radius (m) (refer Figure 8-9)

S = Longitudinal Slope (%)

n = Roughness Coefficient (no unit) (from Table 8-4)

3. Ensure that the channel can convey the peak discharge flow volume calculated above with at least 10% freeboard.

As a guide the values in Table 8-4 should be used in selecting an appropriate roughness coefficient (n) for use in the calculation:

Table 8-4 Mannings roughness coefficient for a range of materials

Surface material	Mannings roughness coefficient (n)
Concrete - Centrifugally spun	0.013
Concrete - Steel forms	0.011
Concrete - Wooden forms	0.015
Concrete/ Asphalt	0.011
Corrugated metal	0.022
Galvanized iron	0.016
Kerb and Channel	0.018
Plastic	0.009
Short Grass	0.15
Light Turf	0.20
Lawns	0.25
Dense Turf	0.35
Pasture	0.35

**Cross Section:** Design diversion channels to be parabolic or trapezoidal in shape. The formula used to calculate the cross-sectional areas (A) and hydraulic radius (R) required for the calculation of capacities is outlined in Figure 8-9.

Ensure the internal sides of the bund associated with the diversions are no steeper than 3:1, and the external sides no steeper than 2:1

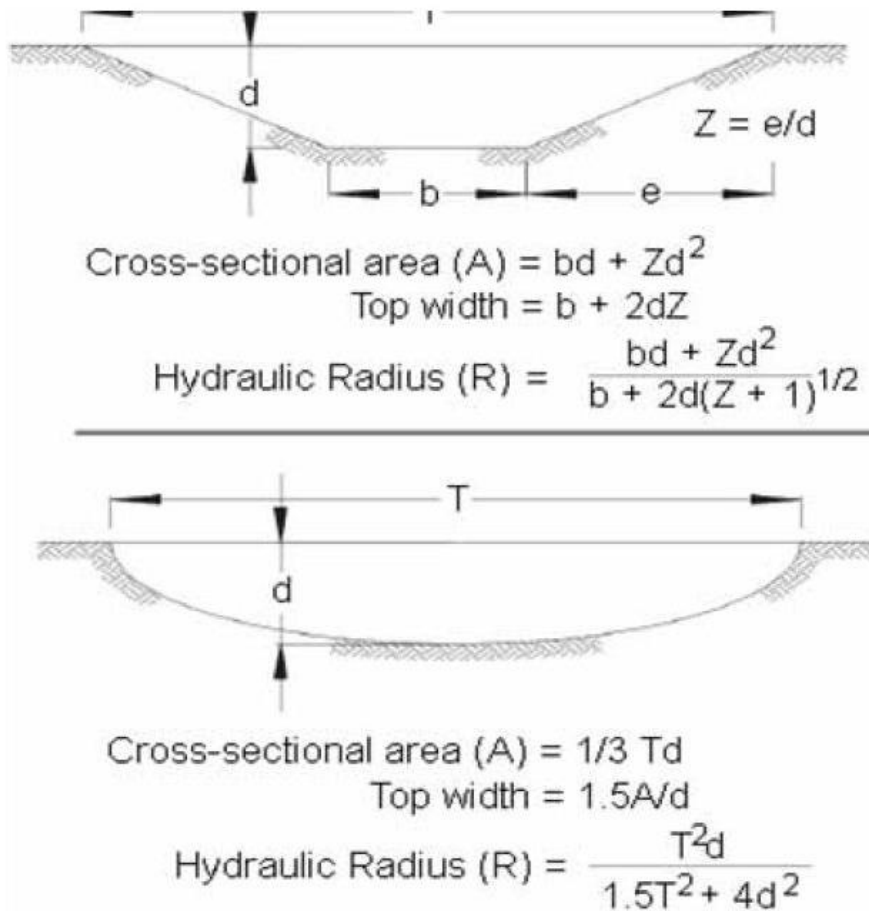

Figure 8-9 Area and hydraulic radius calculations for parabolic and trapezoidal profiles

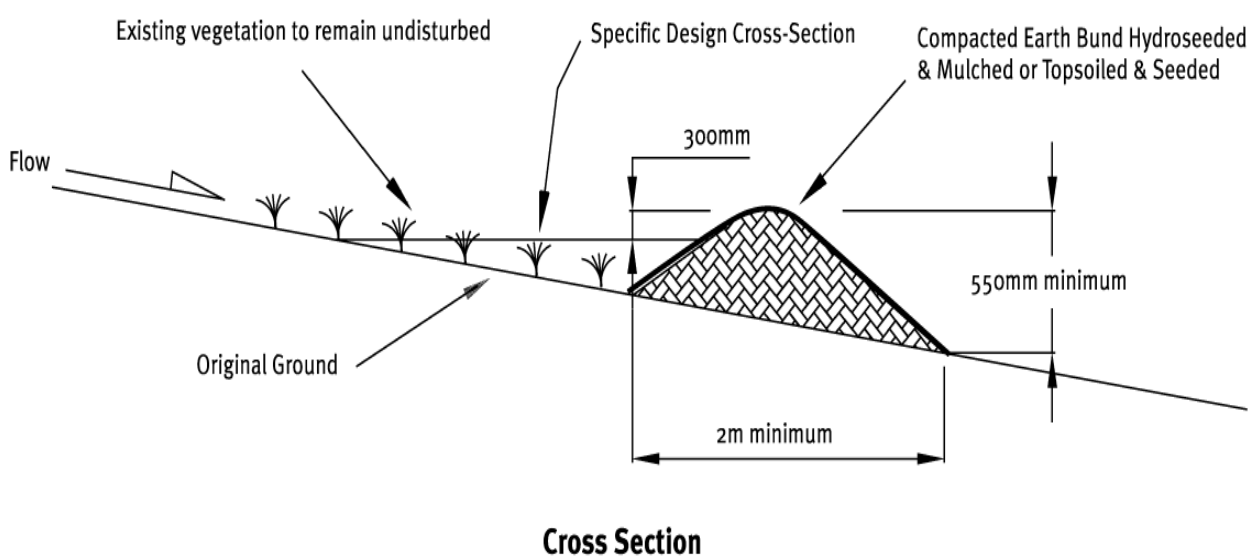

Figure 8-10 Cross section of clean water diversion



**Velocity and Grade:**

For clean water diversion channels, longitudinal grades should be managed to ensure, where practicable, grades do not exceed 2%. However, to ensure they do not become a source of erosion they all need to be armoured with aggregate, grass sward or alternative such that a stabilised surface exists.

For dirty water diversion channels, restrict longitudinal grades to no more than 2%, unless the channel is armoured with geotextile cloth.

Consider the provision of sumps (2m<sup>3</sup>) in dirty water diversion channels every 50metres. These are proving very valuable in trapping the heavier sediments and will allow for more effective overall sediment retention on site. They will need maintenance to allow original capacity to be re-established after every rainfall event.

Avoid abrupt changes in grade which can lead to sediment deposits and overtopping or erosion.

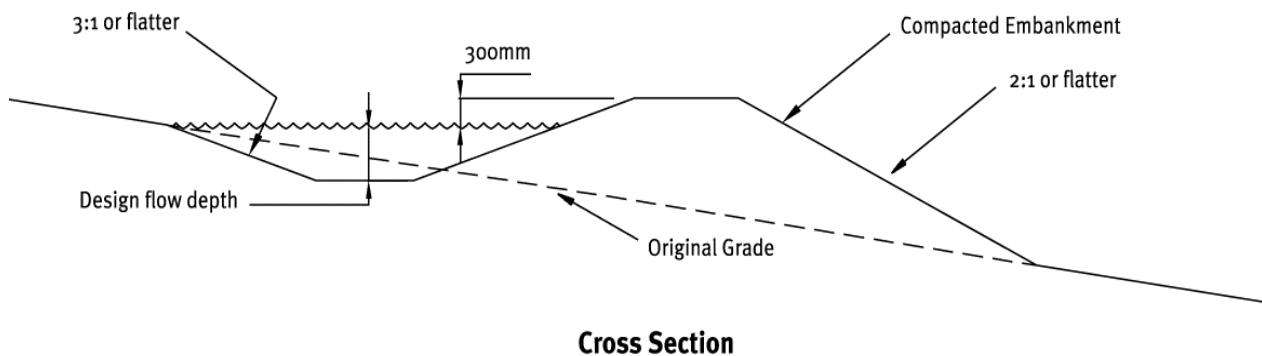

Figure 8-11 Cross section of dirty water diversion

**Stabilisation:** Diversions are to be stabilised in accordance with the stabilisation specifications outlined in section 8.3.

**Outlets:** Provide each diversion with an adequate outlet. The outlet may be a stable channel (e.g. rip-rap, geotextile), vegetated or paved area, stable watercourse or pipe outlet which conveys runoff to a point where outflow will not cause damage (erosion, flooding). If needed, install vegetated outlets before diversion construction, to ensure establishment of vegetative cover in the outlet channel.

The design elevation of the water surface in the diversion is to be higher than the design elevation of the water surface in the outlet at their junction when both are operating at design flow.

Never discharge diversions onto unstable soils, unconsolidated fill slopes or in concentrated flows over the bank of a stream.

8.2.3.5 Maintenance

Diversion channels require regular maintenance to ensure that they keep functioning throughout their life. Maintenance should include the following:

- Inspect weekly, after every rainfall and during periods of prolonged rainfall for scour and areas where breaches could occur. Repair immediately, if required, to ensure that the design capacity is maintained.

- Remove any accumulated sediment deposited in the diversion channel where there is a risk of overtopping due to a lack of freeboard.
- Check invert and outlets to ensure that these remain free from scour and erosion. These points may require geotextile lining to avoid this.
- Look for low spots, areas of water ponding, formation of tunnel gullies, sediment deposition and debris blockage and rectify immediately.
- Check for stabilisation cover and ensure full stabilisation cover remains where required, and
- Bunds need particular care to protect against damage from earthmoving operations and should be reinstated if damaged.
- Sumps need to have sediment trapped removed after rainfall events.

#### 8.2.3.6 Decommissioning

In decommissioning diversion channels and bunds, fill in the channels and spread any remaining banded material, then stabilise all exposed soil.

## 8.2.4 Pipe Drop Structures and Flumes

### 8.2.4.1 Definition and purpose

Pipe drop structures and flumes are used where concentrated flow is to be conveyed down a slope.

Pipe drop structures or flumes may be either temporary or permanent structures and are commonly used in association with diversion channels which act to collect and direct surface runoff into the structure.

Flumes may be used to divert flows down batters to the forebay of sediment retention ponds and also at the final point of discharge into receiving environments.

Flumes may also be used to stabilise an active gully head.

### 8.2.4.2 Conditions where practice applies

- Always use where slopes are steeper than 3:1 and where channelised surface runoff needs to be conveyed down slopes.
- Pipe drop structures and flumes are suitable up to a maximum catchment of 1ha before specific engineering design is required.

### 8.2.4.3 Limitations

Pipe drop structures and flumes have the following limitations:

- The topography of the site needs to allow collection of flow at the inlet.
- Erosion may result if the structures fail by overtopping, piping or pipe separation.
- Damage to the pipe drop structure or flume may result from slippage or slumping caused by unstable foundation material.
- They require regular monitoring and maintenance to ensure that the structures are operating effectively.

### Key design criteria

Temporary pipe drop structures or flumes may be fabricated from needle punched geotextile fabric, concrete, steel or plastic half round pipes, rock, sandbags, lay flat or construction ply. Any number of products can be used, provided they can convey water safely over exposed soils or unstable slopes.



Figure 8-12 Pipe drop structure (note check dams, silt fence and channel protection also)



Figure 8-13 Flume to a sediment retention pond

The following general design criteria are relevant to both pipe drop and flume structures:

- Ensure that structures have a minimum slope of 3% to avoid sediment deposition within the structure.
- The structure is to be impervious and prevent water from flowing under the structure.
- Ensure that the height (when measured from the invert) of any diversion channel, bund or wing wall that is used to divert flows to the pipe drop structure or flume is at least 2 times the pipe diameter or 2 times the height of the flume.
- The inlet to the flume or pipe should be well compacted and include a 1m long stabilised entry apron created by placing impermeable geotextile fabric into the inlet extending a minimum of 1m in front of, and to the side of the inlet and up the sides of the flared entrance. Ensure this geotextile is keyed 150 mm into the ground along all edges) to prevent erosion. This needs to be on at least a 3% grade.
- The flume and pipe drop structure is to extend beyond the toe of the slope being protected and the appropriately protect the outfall by using an energy dissipation device (eg geotextile, sandbags, riprap).



Figure 8-14 Wooden flume lined with impervious material

### Pipe drop structures

Table 8-5 the sizing of temporary culverts should be determined by following the risk based approach in Appendix 13.7 through selecting an appropriate design storm from Table 13-12 based on works duration and type of receiving environment. For very short duration works (less than 2 weeks) with Category B or C receiving environments, culvert size can be determined using 85% of the channel width at bank full, providing appropriate provision is made for overtopping. Consideration should be given to overland flow paths to ensure that larger flows do not cause safety or environmental impacts.

For catchments larger than 1ha, pipe sizing will require specific engineering design using the methodology in Appendix 13.7.

Table 8-5 Sizing criteria for pipe drop structure

Maximum catchment area (ha)	Pipe diameter (mm)	Height of inlet bund / wing wall
0.05ha	150mm	300mm
0.20ha	300mm	600mm
0.60ha	450mm	900mm
1.00ha	500- 600mm	1000-1200mm
>1.00ha	Specific design required	Specific design required

### Flumes

Table 8-6 summarises the basic sizes for flumes with catchments up to 1 ha. For catchments larger than 1ha, flume sizing will require specific engineering design using the methodology in Appendix 13.7. The flume liner should be impervious and prevent water from flowing under the structure.

Table 8-6 Sizing criteria for flumes

Maximum catchment area (ha)	Flume Depth (side wall height)	Flume Width	Height of inlet bund / wing wall
Up to 1.0ha	Minimum 300mm depth	1.2m <sup>1</sup>	Twice depth of flume (minimum 600mm)
Over 1.0ha	Specific design required		

Construct the flume with enough cross-sectional profile to adequately contain flows. Ensure the flume is deep enough so that water stays in it; work to a minimum 300mm depth.

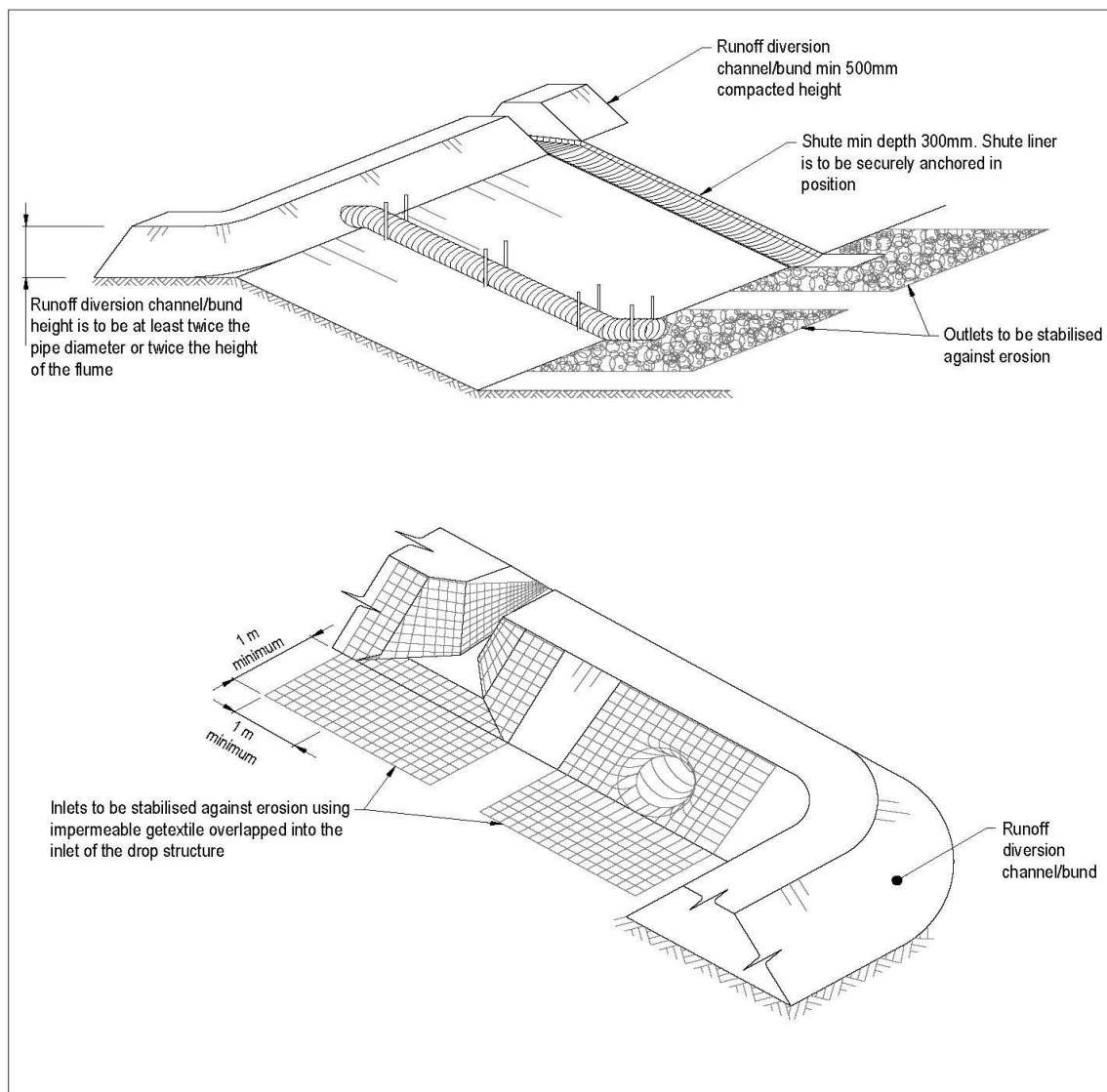

Figure 8-15 Flume and pipe drop structure design. (Figure courtesy of Auckland Council)



#### 8.2.4.4 Maintenance

Pipe drop structures and flumes require regular maintenance to ensure they keep functioning throughout their life, consisting of the following:

- Inspect the pipe drop structure or flume weekly, after each rain event and immediately carry out any maintenance required.
- Keep the inlet open at all times.
- Check for evidence of water bypassing, undermining or water overtopping the pipe drop structure or flume.
- Check for scour at the base of the pipe drop structure or flume or in the receiving downstream area. If eroded, repair damage and install additional energy dissipation measures. If downstream scour is occurring, it may be necessary to reduce flows being discharged into the device unless other preventative measures are implemented.
- Extend the length of the pipe drop structure or flume as earthworks progress and repair and/or modify pipe drop structure or flume as required.
- Keep pipe drop structures or flumes in place until runoff has been controlled and all disturbed areas have been stabilised, or until permanent stormwater systems have been commissioned, and
- Make sure water is not ponding onto inappropriate areas (e.g active traffic lanes, material storage areas etc).

#### 8.2.4.5 Decommissioning

Where temporary pipe drop/flume structures are decommissioned ensure any remaining concentrated flows previously diverted through the structure have an alternative route that does not cause erosion and stabilise any exposed soils.

### 8.2.5 Surface Roughening

#### 8.2.5.1 Definition and purpose

Surface roughening is creation of horizontal grooves extending across the slope on unstabilised, bare soil and can be achieved by tracking with construction equipment.

The purpose of surface roughening is to:

- Alter the soil surface to promote infiltration and reduce erosion by slowing water down.
- Assist in capturing small quantities of sediment in the “hollows” created.
- Rip or scarify bare soil and break up hard or compacted surfaces before seeding for either temporary or permanent revegetation programmes.

#### 8.2.5.2 Conditions where practice applies

Surface roughening is a simple technique that should form part of any works methodology on any slopes that have the potential to generate sediment and slopes which are to be stabilised with vegetation from seed.



Figure 8-16 Surface roughening with a bulldozer

### 8.2.5.3 Limitations

Surface roughening has the following limitations:

- Surface roughening will not generally provide a satisfactory level of erosion control during high-intensity or long-duration rainfall events. Therefore, the technique cannot be relied upon as the only form of control and will require other devices to assist with reducing erosion.
- Ripping or scarification is a technique that should not be used on soils vulnerable to ‘tunnelling’ the practice can exacerbate erosion.
- Do not roughen cut batters in highly erodible soils to the extent that scarification lines are likely to collect water in channels or rills.
- Do not surface roughen very dry, fine-textured soils, as they may be prone to pulverisation, making them more susceptible to detachment and transport by either wind or water.



Figure 8-17 Slope roughening in conjunction with stabilisation

### 8.2.5.4 Key design criteria

There are no formal design criteria for surface roughening although the following principles apply:

- Intercept water that flows onto the works area and divert it away from the areas to be roughened prior to undertaking the works.
- Fill existing rills before roughening or track-walking a batter face see **Error! Reference source not found.**
- Track-walking leaves well-defined cleat impressions in the soil, parallel to the contour. This is necessary in order for the creation of a series of mound and hollow features to act as micro sediment traps.
- When track-walking topsoil material, take care to minimise movements over the same area to avoid compaction of the soil, so that soil structure is protected for future plant and seed germination.

### 8.2.5.5 Maintenance

Periodically check the slopes for signs of erosion (rills and channels). Rework the area as necessary.

### 8.2.5.6 Decommissioning

Check slope for any rilling or erosion, repair as required then topsoil the area and stabilise (rills and channels). Rework the area as necessary.

## 8.2.6 Benched Slopes

### 8.2.6.1 Definition and purpose

Benched slopes entail grading of sloped areas to form reverse sloping benches to reduce slope lengths and minimise potential erosive forces.

The purpose of a benched slope is:

- To break up the catchment of a worked face and limit the velocity and volume of flows down the slope to reduce erosion, and
- To provide for erosion control and vegetation establishment on those areas which are more prone to erosion due to topography.



Figure 8-18 Benched slopes

### 8.2.6.2 Conditions where practice applies

This practice is typically used:

- On long slopes and/or steep slopes where rilling may be expected as runoff travels down the slope. They can be a permanent alternative to temporary contour drains.
- To ensure the long-term stability of the slopes, in conjunction with geotechnical design.
- Benching of the slopes should be a minimum requirement on slopes exceeding 25% and greater than 20m in vertical height unless there are geotechnical considerations preventing this.

Note that benched slopes are often engineered for structural purposes and therefore can have a dual function.

### 8.2.6.3 Limitations

Benched slopes have the following limitations:

- Be aware of geotechnical considerations and check Council requirements. Subsoil drainage may need to be installed to intercept seepage that would adversely affect slope stability or create excessively wet site conditions.
- Do not construct benched slopes close to property boundaries where they could endanger adjoining properties without adequately protecting such properties against sedimentation, erosion, slippage, settlement, subsidence or other related damages.
- Fill material should be free of brush, rubbish, rocks, logs, stumps, building debris and other objectionable material.

### 8.2.6.4 Key design criteria

Although design of the bench slopes will primarily depend on site conditions, the following principles apply:

- Locate the benched slopes to divide the slope face as equally as possible and convey the water from each bench to a stable outlet (e.g. geotextile, flume or rock riprap).
- Soil types, seeps and location of rock outcrops need to be taken into consideration when designing benched slopes.
- The spacing of each successive bench will be based on specific engineering design however will generally be as provided for in the following table.

Table 8-7 Benched slope spacings

Slope of site (% , h:1v, degrees)	Vertical height (m) between benches
50% (2:1, 26.57°)	10
33% (3:1, 18.26°)	15
25% (4:1, 14.04°)	20

**Reverse benches on benched slopes:**

- Reverse Benches should be provided whenever the vertical interval (height) of any slope exceeds 10m.
- Ensure that each reverse bench is a minimum of 2m wide to enable maintenance of the bench.
- Design reverse benches with a reverse slope of 15% or flatter to the toe of the upper slope and with a minimum depth of 0.3m. The gradient to the outlet should be below 2% unless specific design demonstrates otherwise.
- The flow length within a reverse bench should not exceed 250m unless accompanied by an appropriate design and calculations.

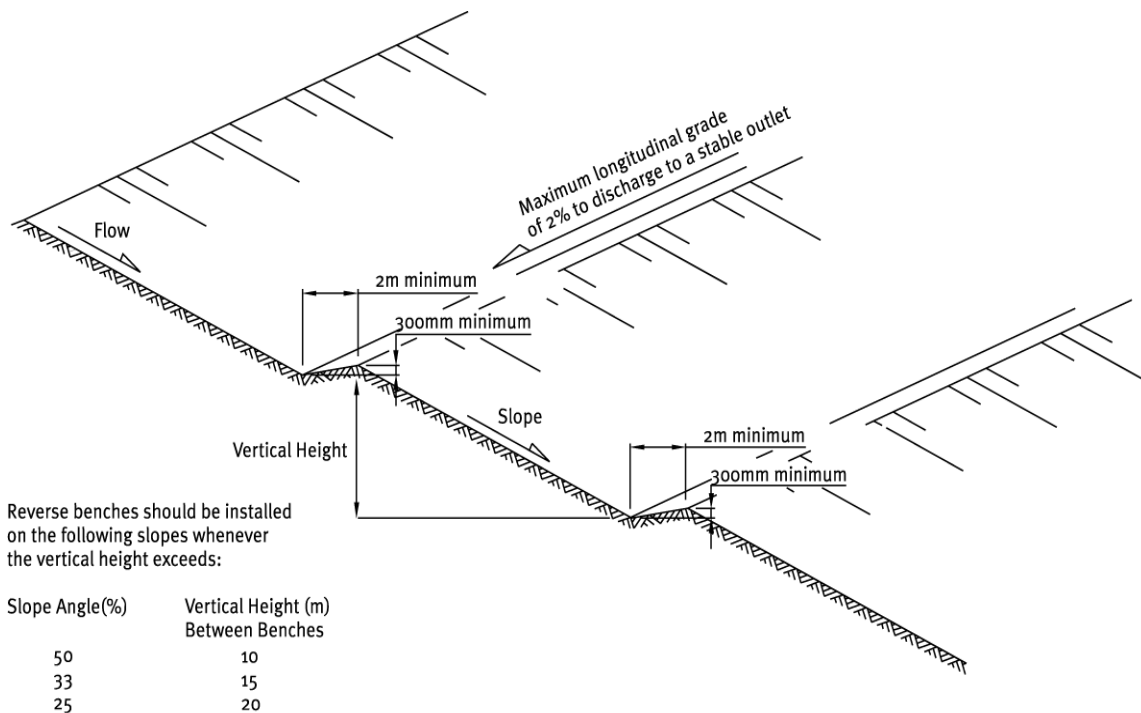

Figure 8-19 Benched Slope with Reverse Benches

Key items to check as part of the regular inspection includes:

- Repair or reinstate the bench slopes and reverse benches if destroyed by machinery movement and after rainfall or storms.
- Check the outfall of the reverse benches for erosion and repair if required. It may be necessary to install a temporary flume or provide geotextile to line these exit points.
- Remove any accumulated sediment within the reverse benches.

#### 8.2.6.5 Decommissioning

Bench slopes are often permanent features and if they do need decommissioning then check the slope and bench area for any rilling or scour, then add topsoil and stabilise.



## 8.2.7 Stabilised Entraceways

### 8.2.7.1 Definition and purpose

A stabilised entranceway is a stabilised pad of aggregate (or equivalent) on a geotextile base located at any entry or exit point of a construction site.

The purpose of a stabilised entranceway is to:

- Provide for a specific site entrance way to avoid multiple entranceways to a site.
- Prevent site access points becoming sources of sediment.
- Keep adjacent road networks and associated stormwater networks free of sediment.
- To assist in minimising dust generation and disturbance of areas adjacent to the road frontage by providing a defined entry and exit point.



Figure 8-20 Stabilised Entraceways

Some circumstances may require a formal wheel wash or a vibrating cattle grate system (shaker ramps) to operate effectively (eg sites with river crossings, contaminated soils, etc). If installing wheel wash facilities, ensure that full water management is considered and addressed to avoid further discharges. This will require the installation of a formal sediment control device.

### 8.2.7.2 Conditions where practice applies

Stabilised entranceways apply:

- At all points of construction site entry and exit (traffic should be limited to these accessways only).
- Where necessary install entranceway in association with shaker ramps or wheel wash facilities as close as possible to the boundary of the works area.

### 8.2.7.3 Limitations

Stabilised entranceways have the following limitations:

- Stabilised entrance ways will reduce sediment movement but will not eliminate it completely. Care needs to be taken to implement other management techniques (e.g. wheel wash, street sweeping) to reduce the potential for vehicles to transport sediment on to road surfaces.
  - The use of a wheel wash system in association with a stabilised entranceway can be expensive, but if managed appropriately may provide much higher efficiencies in terms of sediment removal.
  - On smaller sites where wheel wash systems may be impractical, regular sweeping of adjacent roads and footpaths to keep them clear of debris and sediment may be needed, in particular at the end of each working day and prior to rainfall events. **Do not wash any sediment into the stormwater system or any adjoining watercourse.**
- Do not locate stabilised entrance ways on steep slopes, in areas of concentrated flows, or next to watercourses or stormwater catchpits. If steep slopes or catchpits are unavoidable, entranceways will need specific detailed design to minimise sediment runoff and transportation, including catchpit inlet protection to trap sediment for removal to an appropriate location.

#### 8.2.7.4 Key design criteria

Formal design of stabilised entranceways is generally not required (unless accessways are steep or near watercourses) although the following design principles are required for them to be an effective practice:

- Once a suitable location for a stabilised entranceway has been determined, clear the area of unsuitable material and grade the base to a smooth finish. Place woven geotextile over this area ensuring this is appropriately pinned and overlapped as necessary (refer Figure 8-24)
- Place aggregate from the construction site boundary extending for at least 10m according to the specifications in Table 8-8; and
- Contour the aggregate to suit the entrance point. Note that contouring can include a highpoint on the grade to act as a barrier to water flowing out of the site.

Table 8-8 Stabilised entranceway specifications

Aggregate Size	100 – 105mm washed aggregate
Minimum Thickness	150mm or 1.5 times aggregate size
Minimum Length	10 metres
Minimum Width	4 metres

- Provide drainage from the stabilised entranceway to an appropriate discharge point. This may require a sediment control device (especially if a wheel wash is installed).
- Stabilised entranceways do not necessarily need to be located at the permanent site entry/exit point; however, consideration needs to be given to minimising the number of site entry and exit points.
- Locate all stabilised entranceways so that vehicles cannot bypass these devices. Perimeter silt fences or bunds may assist in achieving this requirement.
- When used with a shaker ramp:
  - A well-designed shaker ramp (eg prefabricated “cattle stop”) allows at least one full revolution of a truck tyre. Two cattle stops should be placed one in front of the other to provide enough length.
  - Stabilise the section of access road between the shaker ramp and the sealed pavement with aggregate.
  - Ensure the runoff from the shaker ramp area and/or wheel wash systems passes through an appropriate sediment control device.
- When used with a wheel wash:
  - Ensure that a water collection and disposal methodology (can include water recirculation) is provided with wheel wash facilities, and
  - If wheel wash runoff cannot be disposed of appropriately in the immediate vicinity, then all overflow should be directed to a sediment control device within the site.



Figure 8-18 Example of a shaker ramp in site access point



Figure 8-19 Stabilised construction entrance showing progression of construction with filter fabric underlay prior to stone placement

### 8.2.7.5 Maintenance

Key items to check as part of the regular maintenance inspection includes:

- Inspect weekly and after each rainfall event for general maintenance requirements.
- Maintain the stabilised entrance way in a condition to prevent sediment from leaving the construction site. This may require several applications of new aggregate during the life of the practice.
- After each rainfall inspect any structure used to trap runoff from the stabilised entrance way and clean out as is necessary.

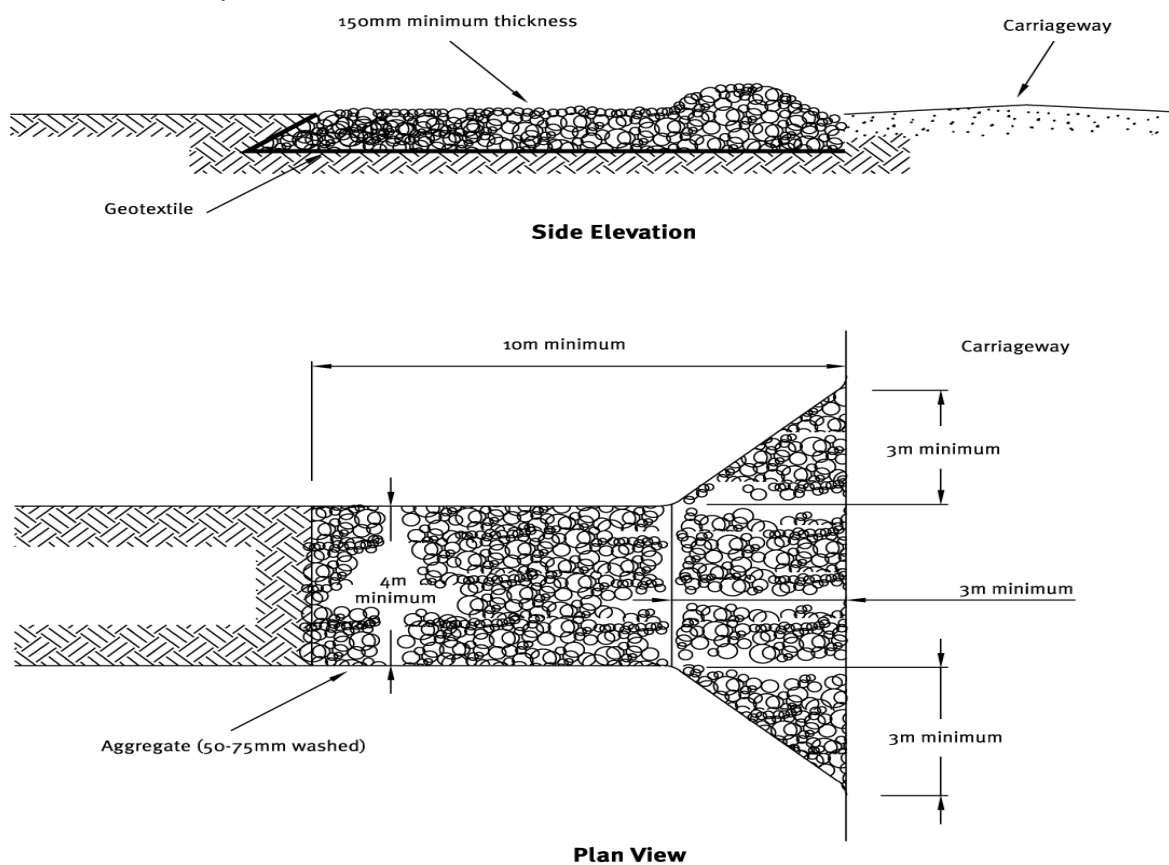

Figure 8-203 Stabilised entranceway

### 8.3 Soil Stabilisation Practices

A stabilised site is one that is resistant to erosion. Stabilisation is defined as applying measures such as vegetative or structural practices that will protect exposed soil and minimise erosion. Common stabilisation measures include spreading of aggregate, grassing (either with grass seed or hydroseed), revegetation, applying mulch and the use of geotextiles.

Stabilisation techniques can be used as either a temporary or permanent measure against erosion. Some techniques can provide instant protection (e.g. geotextiles) while others (e.g. grassing) may take some time before the area is appropriately protected against erosion. In these situations, other erosion and sediment controls may need to be retained in place until a sufficient level of stabilisation is achieved.

In relation to geotextiles, there are many and varied types and products. These range from those that physically shed water through to those that incorporate seed and mulch and so encourage vegetative growth, while protecting the bare soil against erosion.

Where vegetation is used, the disturbed surface is considered stabilised once an 80% vegetative cover has been established over the entire exposed area. Permanently stabilised means vegetation that is self-sustaining meaning it does not require ongoing intense maintenance or irrigation, past the initial establishment phase, to ensure ongoing survival of at least 80% ground coverage. If this is unlikely to be achievable due to site constraints, some other method of permanent stabilisation may be more appropriate.

It is important to consider the steepness and aspect of batter slopes, soil moisture, topsoil and nutrient needs and the plant species used, to ensure the plants selected can cope with the specific site conditions over the long term, particularly with hot dry summers and harsh Tasman sun.

Because vegetation is so effective in protecting soil surfaces and helping to reduce runoff, it can minimise the erosion potential of a site and reduce the need for structural erosion and sediment controls. It is therefore important to preserve as much of the existing vegetation as possible by limiting the extent of works.

Further detail is provided below on the common measures used for stabilisation purposes including:

- Top soiling and Grassing
- Revegetation
- Hydroseeding
- Mulching
- Turfing
- Geotextiles
- Dust Control.



### 8.3.1 Topsoiling and Grass Seeding

#### 8.3.1.1 Definition and purpose

Grass seeding involves the planting and establishment of quick growing and/or perennial grass to provide temporary and/or permanent stabilisation on exposed areas. The practice is often undertaken in conjunction with the placement of topsoil.

#### Key fact

A site is **NOT** stabilised until 80% of the topsoil is covered with grass over 100% of the site.

Grass seed spread over the site and newly germinated seed is **NOT** considered Stabilisation of a disturbed site.

The purpose of grassing is to provide either a short-term or long-term cover for erosion control on disturbed areas. The established vegetation protects exposed soils from raindrop impact, reduces runoff velocity and volume, binds soil particles together and can also inhibit weed growth.

Topsoiling provides a suitable soil medium for vegetative growth for erosion control while providing some protection of the subsoil layer and also increasing the absorption capacity of the soil.

Where grass is used for stabilisation, a disturbed surface is considered stabilised with grass or other vegetation once:

1. 80% vegetative cover has been established over the 100% of the exposed area.
2. Permanently stabilised means the vegetation is self-sustaining - it does not require ongoing intense maintenance or irrigation, past the initial establishment phase, to ensure ongoing survival of at least 80% ground coverage.

If this is unlikely to be achievable due to site constraints, some other method of permanent stabilisation may be more appropriate.

It is important to consider the steepness and aspect of batter slopes, soil moisture, topsoil and nutrient needs and the plant species used, to ensure the plants selected can cope with the specific site conditions over the long term, particularly with hot dry summers and harsh Nelson/Tasman regions sun.



Figure 8-21 Vegetative stabilisation is an effective erosion control practice



No stabilisation

40-60% coverage

Over 80% coverage

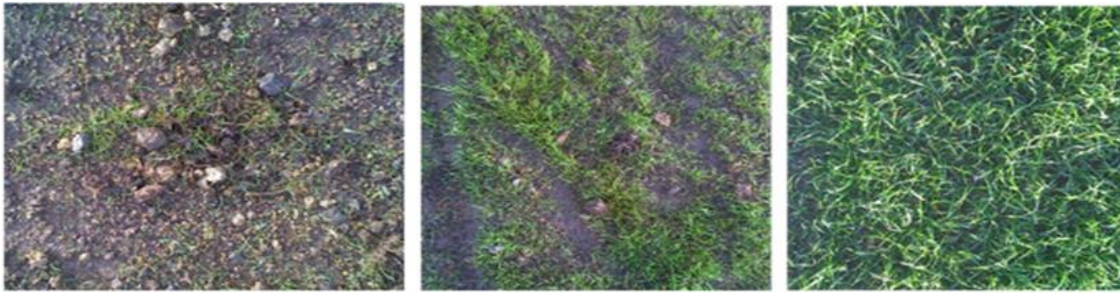

Figure 8-22 Grass strike densities -percent coverage

### 8.3.1.2 Conditions where practice applies:

The practice applies to any site where grass establishment is important for achieving stabilisation once established or landscape purposes.

**Temporary seeding:** As a rapid-growing annual grass will provide a short-term cover. It is primarily used where project works are still progressing but need temporary coverage.

- Use on any cleared or unvegetated areas which are subject to erosion and will not be earth worked for a period of 60 days up to a maximum duration of 12 months.
- Temporary seeding is normally practised where the vegetative cover is required to be in place for less than 12 months. In some circumstances mulching may be used as an alternative.
- Utilise temporary seeding on short to medium-term stockpiles, the outside of sediment pond embankments or diversion bunds, on cut and fill slopes, access/haul road embankments and any other disturbed area that is likely to remain exposed and un-worked for less than 12 months. Permanent seeding may be required for periods greater than 12 months.

**Permanent seeding:** The use of perennial grasses will provide permanent erosion protection to disturbed areas following completion of the earthwork's activity. Ideally, permanent grassing should be undertaken progressively throughout the project as earthworks are finalised and brought to final grade.

- This practice applies to any site where establishing permanent vegetation is important to protect bare earth. It may also be used on rough graded areas that will not be brought to final grade for 12 months or more.

**Topsoiling:** Topsoil provides the major zone for root development and biological activities. Topsoil is important as it is a physically better rooting material, has more nutrients available and air and water is more mobile through it than in clay subsoil layers. Topsoiling is recommended for sites where:

- The texture and/or the organic component of the exposed subsoil or parent material cannot produce and sustain adequate vegetative growth.
- The soil material is so shallow that the rooting zone is not deep enough to support plants or furnish continuing supplies of moisture and plant nutrients to sustain plants over the long term.
- High quality vegetative cover is required to be established.

Dependent upon the site location and the soil structure that exists, soil tests for fertility and the need to add further soil additives may provide benefits.

### 8.3.1.3 Limitations

Grass seeding has the following limitations:

- Establishing a protective vegetative sward is difficult during periods of low rainfall or during periods of temperature extremes. Develop construction sequencing such that topsoiling and seeding occurs during optimum periods (eg Aug-Nov, March-April) for vegetation establishment.
- The newly established seed can be mobilised by intense rainfall and may require several applications to achieve the appropriate stabilisation standard.
- Topsoil alone is not considered stabilised and erosion/sediment control measures should be designed to be in place - until there is an appropriate density of grass strike (80% cover). Alternatively, other stabilisation methods (e.g. mulching) may be used.

#### 8.3.1.4 Key design criteria

For topsoiling and grass seeding use the following criteria:

- **Site preparation:**
  - Prior to seeding, ensure erosion and sediment control practices are still functioning.
  - Final grading and shaping is not necessary for temporary seeding.
- **Seedbed preparation:**
  - It is important to prepare a good seedbed to ensure the success of establishing vegetation. The seedbed should be friable, uniform and free of large clods and other objectionable material. The soil surface should not be compacted or crusted.
  - If the site has contaminated material, ensure that this is fully removed from the topsoil.
  - Apply topsoil at a minimum depth of 100mm to allow for a friable surface.
  - Topsoil is a valuable resource. When placing topsoil in stockpiles ensure that it is isolated by the upslope diversion of clean water runoff, is stabilised appropriately and is not stored in stockpiles greater than 2m in height to maintain soil structure and integrity.
- **Soil amendments:**
  - Apply fertiliser at the rate outlined in
  - Table 8-9 or specific to the site in question. Confirm that this rate and type of fertiliser is appropriate for site conditions with your fertiliser supplier before using.
  - For large sites or unusual soil conditions, soil testing may be required as some soils may require the addition of lime to improve pH and/or trace elements for grass growth.
- **Seed selection:**
  - Select the seed mixture from Table 8-9.
  - Where topsoil is not used (eg recontouring vineyard blocks) only specialist colonising species able to survive long term on subsoil should be used. Ryegrass and clover may still be used, however strike rates can be low and growth slow and fertiliser is required.
  - A mix of grass and pasture species (eg grasses and clovers) allows for natural succession for better short and long term success (ie a rapidly growing grass provides initial cover which is succeeded by clover which is better able to cope with long term site conditions (eg dryness or infertility).
  - Use only certified seed with a high purity and germination percentage from reputable suppliers. Species selection need to consider the project's ecological context and if undertaking permanent seeding, be mindful of the final landscape plans.

- **Seed application:**

- Apply seed uniformly at the rate outlined in Table 8-9. If hydro-seeding is required refer to Section 8.3.2. Traditional agricultural techniques such as drill seeding, broadcast seeding or no tillage are appropriate for establishing grass on areas flatter than 25%. Ensure the methodology achieves a good seed-to-soil contact, thereby enhancing seed survival and germination rates.
- For small areas hand-broadcasting and raking may also be used to apply seed and fertiliser.
- Apply and maintain fertiliser at the rate outlined in Table 8-9.
- If irrigation is required, deliver a volume at least equal to the evapotranspiration rate and continue until natural rainfall provides the necessary soil moisture levels for plant survival.
- Ensure that the site conditions, and the time of the year are appropriate for germination and vegetation establishment prior to undertaking this activity. This may involve the placement of mulch and/or irrigation to achieve.
- In order to maximise germination and growth rates, the preferred seeding windows for both temporary and permanent grassing are autumn and spring.
- Mulching as outlined in Section 8.3.3 should be undertaken in conjunction with the seeding programme during dry or cold periods. This will protect both the seed and the soil, whilst also providing a better microclimate for the germination and growth of grasses.

In all circumstances ensure that the seed and fertiliser application rates and mix is appropriate for your site. Always discuss with your seed and fertiliser supplier prior to utilisation. Seek specific advice when working near areas of high conservation value or very difficult soil conditions.

Table 8-9 Typical seed and fertiliser application rates

Application	Typical seed mix	Application rates for:	
		Up to 20% slope (5h:1v, 11.31°)	Greater than 20% slope (5h1v, 11.31°)
Temporary Seeding	Annual Ryegrass	20 kg/ha	30 kg/ha
Permanent Seeding <sup>1</sup>	Perennial Ryegrass	15 kg/ha	20 kg/ha
	Cocksfoot	2 kg/ha	4 kg/ha
	White clover - pelleted or freshly inoculated with rhyzobia (bacteria that fix nitrogen)	3 kg/ha	4 kg/ha
Maintenance fertiliser 6-12 weeks after seedling germination	12:10:10 (N:P:K) including trace elements	150kg/ha.	150kg/ha.

*Note: if the area is to become fine lawn area, a commercial lawn mix should be used following the producer's recommendations with regard to application and fertilizer rates.*

Any fertilizer application containing nitrogen should be carried out after seedling germination. Any Fertiliser use will need to comply with the permitted activity discharge rules in the Tasman Resource Management Plan or a resource consent is required.

#### 8.3.1.5 Maintenance

The following are to be considered for maintaining topsoiling and grass seeding:

- Check the condition of the topsoil on a regular basis and re-grade and/or replace where necessary so as to always maintain the 100mm minimum depth of topsoil and appropriate surface roughening.
- Heavy rainfall can wash new seeding away before full establishment of the grass. This is particularly evident on smoother hard surfaces, steep slopes and overland flow paths. Where vegetation establishment is unsatisfactory, the area will require a reapplication of seed or consideration will need to be given to other stabilisation techniques.
- Protect all re-vegetated areas from construction traffic and other activities such as the installation of drainage lines and utility services. If required, erect temporary barrier fencing and/or signage to restrict uncontrolled movement of equipment and vehicles onto grassed areas.

### 8.3.2 Hydroseeding

#### 8.3.2.1 Definition and purpose

Hydroseeding is the application of seed, fertiliser and paper or wood pulp with water in the form of a slurry, sprayed over an area to provide for re-vegetation.

The purpose of hydroseeding is to:

- Establish grass and other vegetation on steep and/or inaccessible areas.
- Quickly establish vegetation. Hydroseeding as a standalone measure does not achieve the definition of stabilised although the practice will provide limited protection from raindrop impact for a short time until the grass is established.

#### 8.3.2.2 Conditions where practice applies

This practice applies to any site where vegetation establishment is important for stabilisation or landscape purposes. Typically, it is used:

- On critical areas such as steep slopes or batters and exposed areas near watercourses that require a more rapid germination and stabilisation than conventional hand seeding.
- On areas that may be difficult to establish by conventional sowing methods (e.g. steep embankments and areas with difficult access)
- Around diversion channels/bunds, where rapid establishment of a protective vegetation cover is required before introducing water flow.

Where hydroseeding of grass is used for stabilisation, the disturbed surface is considered stabilised once a minimum of 80% vegetative cover has been established over the 100% of the exposed area. To be considered permanently stabilised, vegetation will have reached a point that it is self-sustaining - meaning it does not require ongoing intense maintenance or irrigation, past the initial establishment phase, to ensure ongoing survival of at least 80% ground coverage. If this is unlikely to be achievable due to site constraints, some other method of permanent stabilisation may be more appropriate.

It is important to consider the steepness and aspect of batter slopes, soil moisture, topsoil and nutrient needs and the plant species used, to ensure the plants selected can cope with the specific site conditions over the long term, particularly with hot dry summers and harsh Tasman sun.

#### 8.3.2.3 Limitations

Hydroseeding has the following limitations:

- Hydroseeding will require specialised equipment to apply and therefore there is a reliance on experienced contractors and local knowledge to ensure that the seed mix is appropriate for the site and conditions over both the short and long term.



Figure 8-236 Hydroseed being applied to a vertical face and the eventual stabilisation (photos courtesy of Erosion Control Ltd).



- Although there is an improved grass strike rate with hydroseeding, it is a more expensive option compared with conventional grass seeding.
- The newly established hydroseed can be mobilised by intense rainfall.
- Hydroseeding is not suitable for permanent stabilisation of steep slopes that are too steep or dry to maintain a healthy long-term vegetation cover. This can be a particular problem on north facing slopes subject to intense summer sun and where there is little or no topsoil to assist with soil moisture retention. If ongoing maintenance and irrigation is not planned and funded for such areas, then some alternative form of permanent stabilisation will need to be implemented. Consideration should also be given to modifying slopes to achieve grades more conducive to vegetation growth or use of hardy colonising plant species which may tolerate the poor conditions and provide a suitable microclimate for other species to be established at a later date.

#### 8.3.2.4 Key design criteria

There are various hydroseed mixes which utilise soil improvements, paper or wood pulp and in some circumstances a binder to help seeds adhere to the soil surface.

- Use only experienced contractors.
- preferably with good local knowledge.
- For larger applications:
  - a soil test should be done to determine rates and whether an alkaline based fertiliser should be used rather than an acid based one.
- Use seed mixes
  - application and fertiliser rates recommended by reputable hydroseeding companies to ensure appropriate seed types and application rates suitable to the specific site conditions.



Figure 8-247 Recently applied hydroseed showing emergent grass growth

#### 8.3.2.5 Maintenance

The following maintenance requirements are required for hydroseeding:

- Heavy rainfall can wash new hydroseeding away before full establishment of the grass. This is particularly evident on smoother hard surfaces and overland flow paths. Where vegetation establishment is unsatisfactory, the area will require a reapplication of hydroseeding or consideration will need to be given to other stabilisation techniques.
- Apply additional fertiliser, as required, following hydroseeding contractor's specifications
- Protect all re-vegetated areas from construction traffic and other activities such as the installation of drainage lines and utility services. If required, erect temporary barrier fencing and/or signage to restrict uncontrolled movement of equipment and vehicles onto grassed areas.

### 8.3.3 Mulching

#### 8.3.3.1 Definition and purpose

Mulching is the application of a protective layer of hay or straw (or other suitable material) to the soil surface to provide an instant surface protection.

The purpose of mulching is:

- Providing a rapid stabilisation technique to protect the soil surface from the forces of raindrop impact and overland flow.
- To help conserve soil moisture, maintain temperatures, reduce runoff and erosion, prevent soil crusting and promote the establishment of desired vegetation.

Mulching for erosion control purposes is usually a short to medium-term treatment. It can be used as a stand-alone surface cover or in conjunction with a seed and fertiliser grassing programme.



Figure 8-258 Application of straw mulch as a temporary ground cover

Although straw (wheat or barley) and hay are the commonly used materials, mulching can also include the application of bark, wood residue and wood pulp spread over the surface of disturbed flatter ground. For permanent stabilisation situations, pebbles or other aggregate may also be used as part of site landscaping.

#### 8.3.3.2 Conditions where practice applies

Mulching can be used at any time where protection of the soil surface is desired, although the following conditions are particularly applicable:

- Where it is critical to achieve an immediate stabilised surface cover and to maintain this cover for the short to medium term (three to five months). This includes stabilisation of areas that have not been worked for a period of time although are proposed to be worked in the future.
- Where a warmer microclimate is required to maintain soil temperatures and avoiding soil temperature fluctuations, which in turn provide for appropriate conditions for seed germination and the establishment of vegetation at most times of the year.

As an alternative to straw or hay mulch, bonded fibre matrix products can be utilised (eg. hydroseed). These are available from specific stabilisation specialists however it is important to recognise that this surface cover is not considered stabilised until sufficient grass strike has occurred. This product is typically used on steeper slopes (30% to 50%) (refer section 8.3.2).



Figure 8-29 Recently applied mulch (Photo courtesy of BOPRC)

### 8.3.3.3 Limitations

Mulching has the following limitations:

- Mulching requires specialised equipment for large areas so that a uniform coverage is obtained. Hand mulching can occur on smaller sites.
- Both hay and straw mulch have a limited period of effectiveness. In general, hay will last for three months and straw mulch up to five months before these materials become part of the soil matrix and effective cover is lost.
- Mulching may introduce weed species and, in some circumstances, may not be an appropriate measure for the site. Care therefore needs to be taken to ensure that weed infestation of the mulched area does not create a future issue.
- If mulch is used as a temporary method of stabilisation to be followed by topsoiling and seeding, consideration may be needed of whether the residual mulch requires removal or digging into topsoil to ensure adequate grass strike is achieved.
- Mulch can be dislodged by intense rainfall or very high winds.
- Plant based or floatable mulch is not an appropriate cover in areas of concentrated flow paths or in stream channel systems. Care is needed so the mulch does not block chemical treatment devices or interrupt the operation of decants in ponds.

### 8.3.3.4 Key design criteria

Consider the following prior to applying mulch:

- Apply straw or hay mulch as unrotted material at a rate of 6,000kg/ha. As a “rule of thumb” a 30mm loose thickness (measured at time of application) is the required coverage and is considered to be in a stabilised state. Ensure mulch material is relatively free of weeds and does not contain noxious weed species. A list of noxious weeds can be obtained from Tasman District Council.
- Avoid application in high winds, use dust suppression methods, if required, until mulch application can be completed
- Undertake hydro-mulch applications in accordance with the manufacturers’ specifications with a minimum of 80% virgin or recycled wood. The application rate will range from 2,200kg/ha to 2,800kg/ha depending on the slope gradient. It should not be used on slope lengths greater than 150m.
- Wood chip can be applied at rates of around 10,000kg/ha to 13,000kg/ha when available and feasible. Bark mulch is generally slow to deteriorate but can affect soil nitrogen levels making it unavailable to plants. It can also result in saps and tannins leaching and causing a change in pH. Wood chip should not be used adjacent to watercourses and on steeper slopes as it can be washed away during flood events blocking downstream areas and infrastructure.
- If site conditions result in difficulties with the mulch material remaining on site (e.g. during windy conditions), the mulch will need to be anchored.



- Forms of anchoring comprise:
  - Crimping – using a tractor drawn implement designed to punch and anchor mulch into the top 5cm of the soil profile. On sloping land, crimping should be done on the contour whenever possible.
  - Binders or tackifiers can be applied directly as the mulch is being distributed at an application rate that matches the manufacturers’ specifications for that specific binder.



Figure 8-30 Straw mulch being crimped into ground to reduce windblown potential

### 8.3.3.5 Maintenance

The following maintenance requirements are required when mulch is used:

- Inspect after each rainfall event or periods of excessively strong winds, and repair or replace any areas of damaged cover.
- Construction equipment can cause disturbance to stabilised areas and may require the erection of a temporary barrier and/or signage to restrict the movement of equipment and vehicles onto mulched areas.
- Maintain 100% surface cover for optimal protection and a reapplication will be required when the integrity and/or surface density has declined.



Figure 8-31 Well applied mulch and vegetative cover – photo courtesy of BOPRC and Ridley Dunphy Environmental Ltd

### 8.3.4 Turfing

#### 8.3.4.1 Definition and purpose

Turfing is the establishment and permanent stabilisation of disturbed areas by laying a continuous cover of already grown grass turf.

The purpose of the practice is to provide rapid stabilisation by the placement of vegetative cover to stabilise exposed areas.

Turfing (“instant lawn”) may also be used to establish a vegetative filter or buffer along footpaths, driveways, kerbs and channels. The practice provides instant results from a visual and erosion control perspective.



Figure 8-32 Turf being applied to provide immediate ground cover

Turf is considered to provide instant stabilisation as it protects exposed soil from rainfall impact and overland flow, however, to be considered as permanently stabilised the turf should be firmly rooted to the original ground surface and retain at least an 80%

vegetative cover over the entire exposed area. The turf vegetation will have reached a point that it is self-sustaining - meaning it does not require ongoing intense maintenance or irrigation, past the initial establishment phase, to ensure ongoing survival of at least 80% ground coverage (unless this has been included in ongoing maintenance considerations – eg in a residential situation). If this is unlikely to be achievable due to site constraints, some other method of permanent stabilisation may be more appropriate.

It is important to consider the steepness and aspect of batter slopes, soil moisture, topsoil and nutrient needs and the plant species used, to ensure the plants selected can cope with the specific site conditions over the long term, particularly with hot dry summers and harsh Tasman sun.

#### 8.3.4.2 Conditions where practice applies

This practice is typically used where:

- Critical erosion prone areas on the site that cannot be stabilised by conventional sowing or other stabilisation methods.
- Runoff diversion channels and other areas of concentrated flow where velocities will not exceed the specifications for a grass lining.
- Areas around grass stormwater inlets, swales, embankments, road berms and other areas that require immediate grass cover for landscaping purposes.



Figure 8-3326 Turf being applied for a swale outfall

#### 8.3.4.3 Limitations

Turfing can be a relatively expensive option to achieve a stabilised surface although it has the dual advantage of providing erosion control, as well as being suitable for landscaping of a feature.



#### 8.3.4.4 Key design criteria

Appropriate criteria for turfing are:

- The following criteria should be met for turf placement:
  - Rake soil surface to break crust prior to laying turf.
  - During periods of high temperature, lightly irrigate the soil immediately prior to placement. Do not install on hot, dry soil, compacted clay, frozen soil, gravel or soil that has been treated with pesticides as this can damage the roots of the turf and prevent root growth into the original ground surface.
  - Turf strips should be laid on the contour, never up and down the slope, starting at the bottom of the slope and working up. Install strips of turf with their longest dimension perpendicular to the slope and stagger the joints.
  - Do not stretch or overlap turf strips.
  - All joins should be butted tightly to prevent voids which would cause drying of the roots. Also, open spaces may cause erosion.
  - On slopes steeper than 3H:1V, secure turf to surface soil with wood pegs, wire staples or split shingles. Use of ladders will facilitate work on steep slopes and prevent damage to the turf.
- Roll and tamp turf immediately following placement to ensure solid contact of root mat and soil surface.
- Care needs to be taken to ensure that flow velocities travelling over the turfed area will not cause erosion. In these circumstances which often relate to steeper areas, turf reinforced with geotextiles should be considered. Refer to manufacturers' specifications for flow velocities applicable for the various geotextiles.

#### 8.3.4.5 Maintenance

The following maintenance is required for turfing:

- Water daily during the first week of laying the turf unless there is adequate rainfall.
- Check to ensure that the turf is firmly rooted to the original ground surface. Do not mow the area until the turf is firmly rooted.
- Apply fertiliser as required in accordance with supplier's specifications.

### 8.3.5 Geotextiles and erosion control blankets

#### 8.3.5.1 Definition and purpose

Geotextiles, plastic covers and erosion control blankets are used to stabilise disturbed soil areas and protect soils from erosion by wind or water.

The purpose of the practice is to:

- Instantly reduce the erosion potential of the disturbed areas and/or reduce or eliminate erosion on critical sites.
- Permanently or temporarily control erosion.
- Enable revegetation of difficult sites (eg steep areas where topsoil is unstable).

Geotextiles are generally considered to provide instant temporary stabilisation as they protect exposed soil from rainfall impact and overland flow.



Figure 8-34 Erosion control blanket for slope protection. Notice grass growing through blanket

#### 8.3.5.2 Conditions where practice applies

These measures are used when disturbed soils may be particularly difficult to stabilise, including the following situations:

- In critical erosion-prone areas such as sediment retention pond outlets and inlet points.
- In channels where the design flow produces tractive shear forces greater than existing soils can withstand which leads to erosion of the soil surface.
- On a temporary basis in areas where there is inadequate space to install sediment controls, so that good erosion control is vital.
- In areas that may be slow to establish an adequate permanent vegetative cover. In this situation, the geotextile provides an early protective layer. Maintenance issues for the vegetation component are dealt with in section 8.3.1.
- On short steep slopes, batters, or stockpiles during periods of inactivity on the site.
- In situations where tensile and shear strength characteristics of conventional mulches limit their effectiveness in controlling runoff velocities, such as overland flow paths.
- In areas where the downstream environment is of high value and rapid stabilisation is required.

#### 8.3.5.3 Limitations

The practice has the following limitations:

- Blankets and mats are generally not suitable for excessively rocky sites, or areas where the final vegetation will be mowed as the staples and netting can catch in mowers.
- Blankets and mats that are removed should be disposed of to an approved location, prior to application of permanent soil stabilisation measures, unless they are specifically designed for use with permanent revegetation and made of 100% natural fibres which will biodegrade over time.
- Geotextiles do not generally provide the same level of benefit to soil quality as many of the traditional plant-based mulches (e.g. straw mulch).

- Most geotextiles have a limited working life of generally no more than 6 to 9 months, and some materials may be prone to UV degradation. The material can be flammable and can be subject to vandalism. Any degrading or vandalised geotextile should be removed and disposed of to an approved location, unless it is made of 100% natural fibres which will biodegrade over time.
- Some geotextiles may contain a fine synthetic mesh or netting that can pose a threat to a number of aquatic species and birds and should not be used in flow paths or stream areas.
- The use of solid plastic covers should be limited to covering stockpiles, or very small graded areas for short periods of time until alternative measures such as seeding, and mulching may be installed.
- Geotextiles, mats, plastic covers and erosion control covers have maximum flow rate limitations; consult the manufacturer for proper selection.



Figure 8-35 Plastic cover to prevent slope erosion

#### 8.3.5.4 Key design criteria

The use of geotextiles is typically categorised into temporary degradable geotextiles and permanent non-degradable geotextiles.

Biodegradable rolled erosion control products (RECP's) are typically comprised of jute fibres, curled wood fibres, straw, coconut fibre or a combination of these materials which are spun and woven into mats. For a RECP to be considered 100% biodegradable, the netting, sewing or adhesive system that holds the biodegradable mulch fibres together also need to be biodegradable.

Biodegradable erosion control mats should be used in situations where it is not desirable to have nonbiodegradable materials, such as works on stream channels and banks (where products might be washed downstream in large flood events), and in areas where control mats are intended to remain in place following revegetation and where their erosion protection function will eventually be superseded by vegetative cover.

Non-biodegradable rolled erosion control products are typically comprised of polypropylene, polyethylene, nylon or other synthetic fibres. In some cases, a combination of biodegradable and synthetic fibres is used to construct the rolled erosion control products.

Netting used to hold these fibres together is typically non-biodegradable as well.

It is vital to ensure the geotextile selected is appropriate to the intended use and site conditions particularly in permanent situations including consideration of permeability thickness and tensile strength.



Figure 8-36 Plastic cover providing slope protection with plantings placed throughout the cover

For specific construction and design specifications and to ensure that the appropriate product is used for the conditions, refer to the manufacturers themselves and the product information sheets supplied by the manufacturer.

### 8.3.5.5 Key installation considerations

All natural and synthetic geotextile products will need to be installed to the manufacturers' specifications (including site preparation) to achieve:

- Good anchorage, keying-in and overlap of geotextiles to ensure complete and direct contact with soil and that they are not damaged, undercut or removed by wind or runoff.
- Good strike rate and growth of seeded or planted vegetation undertaken in conjunction with geotextile use.
- Good erosion control protection is achieved for the required length of time before works are finished and permanent stabilisation achieved

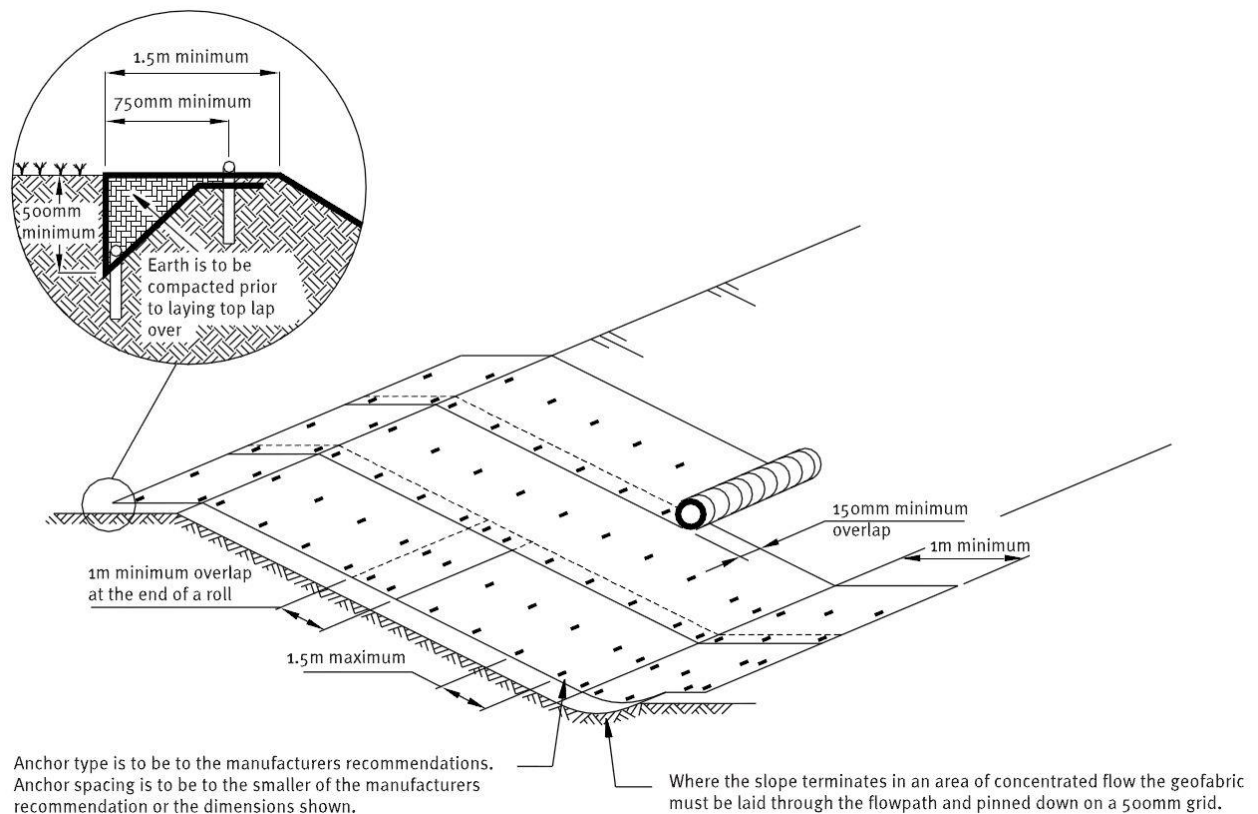

Figure 8-27 Geotextile Design on slopes (figure courtesy of Auckland Councils)



### 8.3.5.6 Maintenance

Areas treated with geotextiles and other synthetics should be inspected daily and after each rainfall event. They should be maintained to provide appropriate erosion control and be repaired, reapplied or replaced if damage occurs or if the area becomes exposed or exhibits visible erosion. The maintenance aspects to look for include:

- Lifting geotextile caused by anchor failure or vegetation growing up under the fabric
- Rilling caused by water flowing beneath the geotextile
- Torn geotextile, missing pins or other damage caused by high winds, machinery or vandalism
- Any areas of geotextile damaged or dislodged in any way should be repaired or replaced.
- If required, erect a temporary barrier and/or signage and fencing to restrict uncontrolled movement of equipment and vehicles onto treated areas.

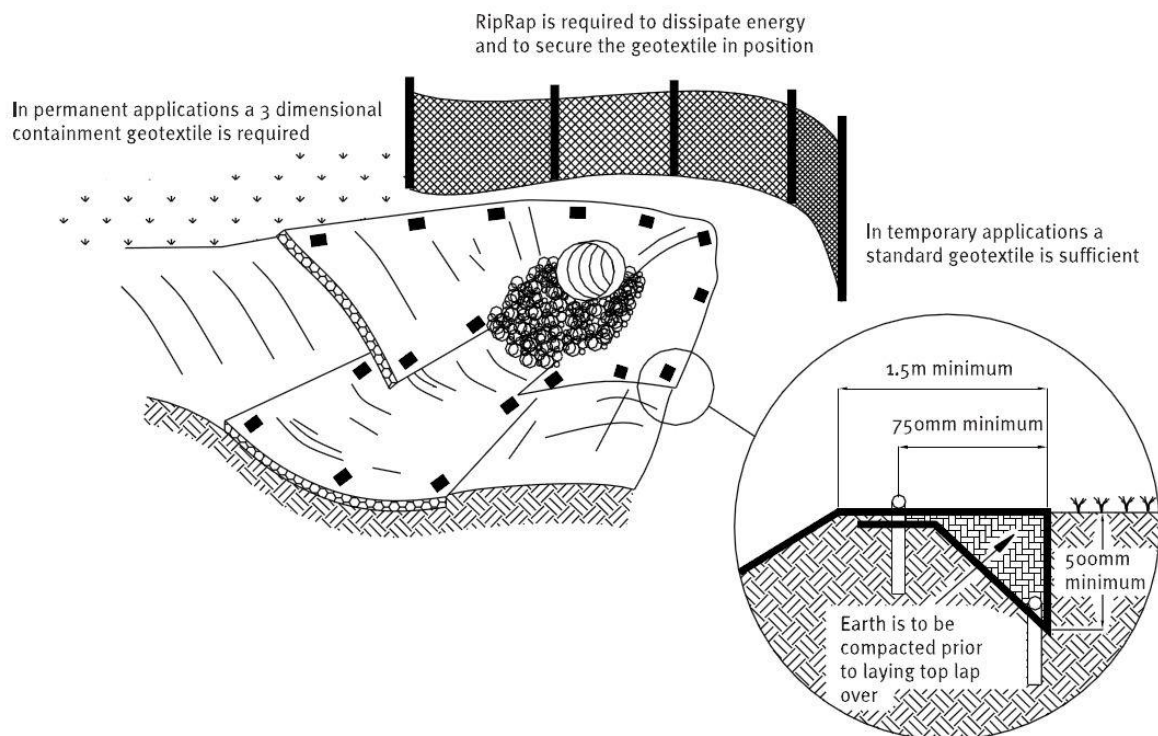

Figure 8-28 Geotextile Design on outfalls (figure courtesy of Auckland Councils')

### 8.3.5.7 Decommissioning

When decommissioning geotextiles and other synthetics undertake the following:

- If geotextile is temporary, remove it and stabilise the area using a permanent stabilisation method.
- If geotextile is part of a permanent solution (eg as part of a revegetation programme), ensure good stabilisation occurs (ie. at least 80% coverage), otherwise geotextile should be renewed, or another stabilisation method should be employed until long term permanent stabilisation is achieved.

Biodegradable systems can be left to decompose, however some other long-term stabilisation (eg revegetation) should be achieved before the erosion protection provided by the geotextile is lost.



### 8.3.6 Dust control

#### 8.3.6.1 Definition and purpose

Dust control includes preventing dust creation and dust transport on and off site.

Typically, water is used as a dust suppressant, but there are also chemical suppressants which may be utilised with appropriate resource consent from Council.

#### 8.3.6.2 Conditions where practice applies

The practice is applicable to areas where dust could cause adverse effects, such as health hazards, nuisance, traffic safety problems and off-site damage. For example, sites close to residential areas, airports, and sensitive receiving environments.



Figure 8-39 Dust suppression by water sprinkling

Under certain conditions, some of the chemicals used for dust control may also be used for bare soil stabilisation, for example in situations where the introduction of organic materials (eg mulch) would be undesirable such as on roadbeds and in structural fill. A resource consent is likely to be required in these situations.

#### 8.3.6.3 Limitations

Dust control has the following limitations:

- The effectiveness of the practice depends on soil, temperature, humidity and wind velocity and direction.
- The availability of sufficient water if the supply is limited.

#### 8.3.6.4 Key design criteria

Dust control should be considered early in the planning stages of any land disturbance project. Forward planning and management to minimise dust problems provide the best options for control. If dust management is only addressed after it has become a problem on site, it is very difficult to bring under effective control until the site has been stabilised.

The following methods for dust control may be appropriate:

- **Water Sprinkling**

- This is the most commonly used dust control practice and should be suitable for all Tasman soil types. Water is normally applied for dust suppression via a water cart or by sprinkler system and either system requires a minimum amount of water to achieve effective dust control.
- Generally, the minimum amount of water required to control potential dust problems is 5mm/day. This should be repeated so that the ground remains moist.
- Water carts can carry from 3,000L to 10,000L, however their use is limited by the ability of the vehicle to access the areas that require wetting.
- The use of a sprinkler system may also be used where there are large areas open or where the terrain is too steep for water carts. Sprinkler systems are commonly used where irrigation may be useful to establish vegetation following works completion.

- A reliable source of water is required and can be sourced from sediment retention ponds or authorised water takes (bore, stream, lake or municipal water supply). Approval to take from these supplies may be required from Council.

- **Adhesives and Binders**

- Adhesives and Binders are generally synthetic materials that are applied to the soil surface to act as binding agents and are for use on mineral soils only. Specific application rates apply depending on the type and use.
- In the Tasman district a resource consent is required to use any chemicals for dust control.

- **Barriers**

- Place barriers such as solid board fences, fences with dust suppression jets, at right angles to the prevailing air currents.
- These should be placed at intervals of approximately 10 times their height.

- **Mulches and Vegetation**

- Refer to sections 8.3.1 to 8.3.4 for the specifications on mulching and grass establishment.

#### 8.3.6.5 Management Practices

Where a Dust Management Plan is required by a resource consent it should generally include the following:

- Soil characteristics of the site and whether the timing/staging of operations will assist in dust reduction
- Wind direction
- Methods used to reduce vehicle speeds
- Operational considerations – staging of area, progressive stabilisation etc
- Types of measures used – water, vegetation and/or chemical suppressants;
- Resource Consent conditions to be met
- Contingency measures in place for severe wind problems (e.g. ceasing works if the primary method of control is not effective for the wind conditions)
- Signage and indications of contact numbers for dust complaints.

A dust management plan may be included as part of the site Erosion and Sediment Control Plan.

#### 8.3.6.6 Maintenance

The following maintenance requirements to be considered:

- Periodically inspect areas that have been protected to ensure adequate coverage.
- Dust monitoring should become part of your general site monitoring and may also be required as a condition of consent for the project.

#### 8.3.6.7 Decommissioning

Prior to decommissioning dust controls ensure that good site stabilisation occurs.

# Chapter 9

## Sediment Control Practices

NELSON TASMAN  
**EROSION AND SEDIMENT  
CONTROL GUIDELINES**

JULY 2019





## TABLE OF CONTENTS

<b>9</b>	<b>SEDIMENT CONTROL PRACTICES .....</b>	<b>1</b>
<b>9.1</b>	<b>Sediment Retention Ponds .....</b>	<b>2</b>
9.1.1	Definition and purpose.....	2
9.1.2	Conditions where practice applies.....	2
9.1.3	Limitations.....	2
9.1.4	Key design criteria .....	3
9.1.5	Construction specifications.....	16
9.1.6	Maintenance .....	16
9.1.7	Decommissioning .....	17
<b>9.2</b>	<b>Silt Fences .....</b>	<b>18</b>
9.2.1	Definition and purpose.....	18
9.2.2	Conditions where practice applies.....	18
9.2.3	Limitations.....	18
9.2.4	Key design criteria .....	19
9.2.5	Construction.....	23
9.2.6	Maintenance .....	23
9.2.7	Decommissioning .....	23
<b>9.3</b>	<b>Super Silt Fence .....</b>	<b>24</b>
9.3.1	Definition and purpose.....	24
9.3.2	Conditions where practice applies.....	24
9.3.3	Limitations.....	24
9.3.4	Key design criteria .....	25
9.3.5	Construction.....	27
9.3.6	Maintenance .....	28
9.3.7	Decommissioning .....	28
<b>9.4</b>	<b>Decanting Earth Bund .....</b>	<b>29</b>
9.4.1	Definition and purpose.....	29
9.4.2	Conditions where practice applies.....	29
9.4.3	Limitations.....	29
9.4.4	Key design criteria .....	29
9.4.5	Construction.....	30
9.4.6	Maintenance .....	31
9.4.7	Decommissioning .....	31
<b>9.5</b>	<b>Flocculation .....</b>	<b>33</b>
9.5.1	Definition and purpose.....	33
9.5.2	Conditions where the practice applies.....	33
9.5.3	Limitations.....	34
9.5.4	Key design criteria .....	34
9.5.5	Decommissioning .....	36
<b>9.6</b>	<b>Dewatering.....</b>	<b>37</b>
9.6.1	Definition and purpose.....	37
9.6.2	Conditions where practice applies.....	37
9.6.3	Limitations.....	37
9.6.4	Key design criteria .....	37
9.6.5	Maintenance and Decommissioning .....	38



<b>9.7</b>	<b>Sediment Sump .....</b>	<b>38</b>
9.7.1	Definition and Purpose .....	38
9.7.2	Conditions where practice applies.....	38
9.7.3	Limitations.....	38
9.7.4	Key Design and Construction Criteria .....	38
9.7.5	Maintenance .....	39
9.7.6	Decommissioning .....	39
<b>9.8</b>	<b>Stormwater Inlet Protection .....</b>	<b>41</b>
9.8.1	Definition and purpose.....	41
9.8.2	Conditions where practice applies.....	41
9.8.3	Limitations.....	41
9.8.4	Key design and construction criteria .....	42
9.8.5	Maintenance .....	43
9.8.6	Decommissioning .....	44

## LIST OF TABLES

Table 9-1	Silt fence design criteria .....	19
Table 9-2	Super silt fence design criteria .....	25

## LIST OF FIGURES

Figure 9-1	Sediment Retention Ponds (forebay in foreground of upper photo, decants in lower photo)	2
Figure 9-2	Schematic of a Sediment Retention Pond (Auckland Councils')	4
Figure 9-3	Level Spreader and Forebay.....	7
Figure 9-4	Level Spreader .....	8
Figure 9-5	Sediment retention pond detail showing multiple decants .....	9
Figure 9-6	Sediment Retention Pond – Decant Detail (Auckland Councils').....	10
Figure 9-7	Sediment Retention Pond T-bar decant system for Catchments less than 1.5 ha .....	11
Figure 9-8	Sediment Retention Pond T-bar decant system for Catchments Between 1.5 – 3 ha.....	12
Figure 9-9	Sediment Retention Pond T-bar decant system for Catchments Between 3 – 5 ha.....	13
Figure 9-10	Filter Collar Schematic Detail .....	15
Figure 9-11	Construction of a Sediment Retention Pond .....	16
Figure 9-12	Silt fence with returns to reduce lateral water movement .....	18
Figure 9-13	Schematic of a Silt Fence.....	20
Figure 9-14	Super Silt Fence .....	24
Figure 9-15	Schematic of a Super Silt Fence .....	26
Figure 9-16	Decanting Earth Bund .....	29
Figure 9-17	Decanting Earth Bund with a Floating Decant .....	30
Figure 9-18	Floating Decant in DEB .....	30
Figure 9-19	Cross-section Decanting earth bund.....	31
Figure 9-20	Rain Activated Flocculant Dosing System (Auckland Council) .....	33
Figure 9-21	Modified Skip Bin for Dewatering .....	37
Figure 9-22	Dewatering Pipe Sock and Bag.....	38
Figure 9-23	Sediment Sump (source ARC TP90 1999) .....	40
Figure 9-24	Stormwater Inlet Protection – silt fence and geotextile sock.....	41
Figure 9-25	Inlet protection with aggregate on top of geotextile fabric.....	42
Figure 9-26	Stormwater Inlet Protection Filter Media Design.....	43
Figure 9-27	Sandbag check dam in gutter.....	43

## 9 SEDIMENT CONTROL PRACTICES

The sediment controls outlined in this section are:

- Sediment Retention Ponds
- Decanting Earth Bunds
- Super silt Fences
- Silt Fences
- Flocculation
- Dewatering
- Sediment sumps
- Storm inlet protection.

The success of sediment control devices is not solely dependent on their capacity, but also other important design features, correct construction and regular maintenance and monitoring to ensure optimum treatment efficiencies.

Soil particle size and catchment size, characteristics and hydrology are critical factors that can influence device sizing and their location. These factors are extremely variable and need to be taken into account on a site-by-site basis when developing an ESCP for your project.

The process for device selection and sizing should include the following aspects (refer also Appendix 13.7):

- A risk analysis to determine:
  - the potential for erosion and expected sediment yields
  - the size, land cover and soil types of contributing catchments
  - the sediment transport pathways on and off the site
  - the types and sensitivity of receiving environments
- A soils analysis (including a soil particle analysis if sediment retention ponds are considered).
- Determination of works methodologies including staging and sequencing.
- Sizing of storage requirements as per Appendix 13.7.
- Determination if flocculation is required.

For sites on Moutere Gravels it is likely that flocculation will be required to adequately control fine sediments. Refer section 9.5 for further information on flocculation.

## 9.1 Sediment Retention Ponds

### 9.1.1 Definition and purpose

A sediment retention pond (SRP) is a temporary pond formed by excavation into natural ground or by the construction of an embankment and incorporating a device to dewater the pond at a rate that will allow the majority of suspended sediment to settle out.

The purpose of a sediment retention pond is to provide a low velocity environment where suspended sediments can settle and also to provide some detention of water runoff. This reduces the volume of sediment leaving a site and helps protect downstream environments from excessive sedimentation, water quality degradation and impacts of increased flow on stream channels.



### 9.1.2 Conditions where practice applies

Sediment retention ponds are appropriate where treatment of sediment laden runoff is necessary and are generally considered the appropriate control measure for exposed catchments of more than 0.3 ha.

It is vital that the sediment retention pond is maintained until the disturbed area is fully protected against erosion by permanent stabilisation (refer section 9.3).



### 9.1.3 Limitations

Sediment retention ponds have the following limitations:

- Sediment retention ponds can occupy significant space (footprint and associated side slopes). This needs to be recognised when designing an ESCP.
- Embankment and spillway stability are generally the weak points in sediment retention pond construction. Correct compaction particularly around emergency spillways and discharge pipes and the use of antiseep or filter collars, will keep the system robust. In a number of cases (e.g. steep slopes and low strength soils) specific geotechnical design will be required.
- Decant systems can become blocked resulting in overtopping and poorly treated runoff discharging to the receiving environment. Pulley systems attached to decants can assist, however maintenance is paramount to ensure that overtopping and sediment discharge does not occur.
- The pond features need to be carefully monitored and reviewed once constructed to ensure the pond operates as designed.
- Sediment retention ponds are often not effective in areas with fine grained soils such as on Moutere Gravels. The presence of suspended fine clays will require the use of flocculants. In these areas it is necessary to ensure that erosion control practices are a key focus to reduce sediment loads and adequately protect the receiving environment.

Figure 9-1 Sediment Retention Ponds (forebay in foreground of upper photo, decants in lower photo)

#### 9.1.4 Key design criteria

The sediment retention pond design is such that very large runoff events will receive at least partial treatment and smaller runoff events will receive a high level of treatment. To achieve this, the energy of the inlet water needs to be low to minimise re-suspension of sediment and the decant rate of the outlet also needs to be low to minimise water flow-through rates and to allow sufficient detention time for the suspended sediment to settle out (Refer Figure 9-2).

Specific design criteria are discussed in the sections below including:

- Pond location.
- Pond volume.
- Pond shape and depth.
- Specific pond features (embankments, baffles, forebay, level spreader, decants and outlet and primary and emergency spillways).

General design criteria can be summarised as the following:

- Use sediment retention ponds for bare areas of 0.3 ha or greater.
- Restrict catchment areas to less than 5ha per sediment retention pond. This limits the length of overland flow paths and reduces maintenance problems. If larger catchments are to be treated specific design and detail will need to be provided.
- Locate sediment retention ponds to provide a convenient collection point for sediment laden flows from the catchment area. This will require strategic use of cut-offs, runoff diversion channels and contour drains.
- Provide maintenance access to allow for removing sediment from the pond.
- Wherever possible, locate sediment retention ponds to allow the primary outlet and spillway to discharge over undisturbed, well vegetated ground.
- Keep the sediment retention ponds life to less than two years. If a longer term is required then further measures to ensure stability and effectiveness are likely to be needed.
- **Never** locate sediment retention ponds within watercourses or flood flow paths.

##### 9.1.4.1 Safety

Sediment retention ponds are attractive to children and can become safety hazards if not appropriately fenced and if safety rules are not followed. Low gradient pond batters provide an additional safety measure allowing people to easily get out if they fall in. Department of Labour guidelines for general safety in the construction industry also recommend that “*excavations are fenced, and, if they are like to retain water, are covered and securely fenced to prevent access for children. If in public places, they should have warning signs, and warning lights at night.*” (DoL 1995).

##### 9.1.4.2 Requirement for flocculation

If any of the following may occur, flocculation should also be used in ponds to provide better retention of fine sediments:

- If pond sizes calculated using the design method in Appendix 13.5 cannot be met on site due to land availability, site topography or works layout.
- If the preferred pond shape and ratios cannot be met on site due to land availability, site topography or works layout.

- If contributing catchment soils have particularly high levels of clays, such as areas within Moutere Gravels.
- If the pond, once operational, is allowing the discharge of excessively dirty water that mean discharges are unlikely to meet the TRMP and NRMP discharge standards.
- If receiving environment is particularly sensitive to sediment discharges and a high level of treatment is required.

When designing a flocculant-dosed sedimentation pond the following features should be included:

- Turbulence can be helpful at the dosing point to aid in mixing.
- Provision of a suitable flat area to locate a flocculant dosing shed and all-weather vehicle access to the shed for monitoring and maintenance.

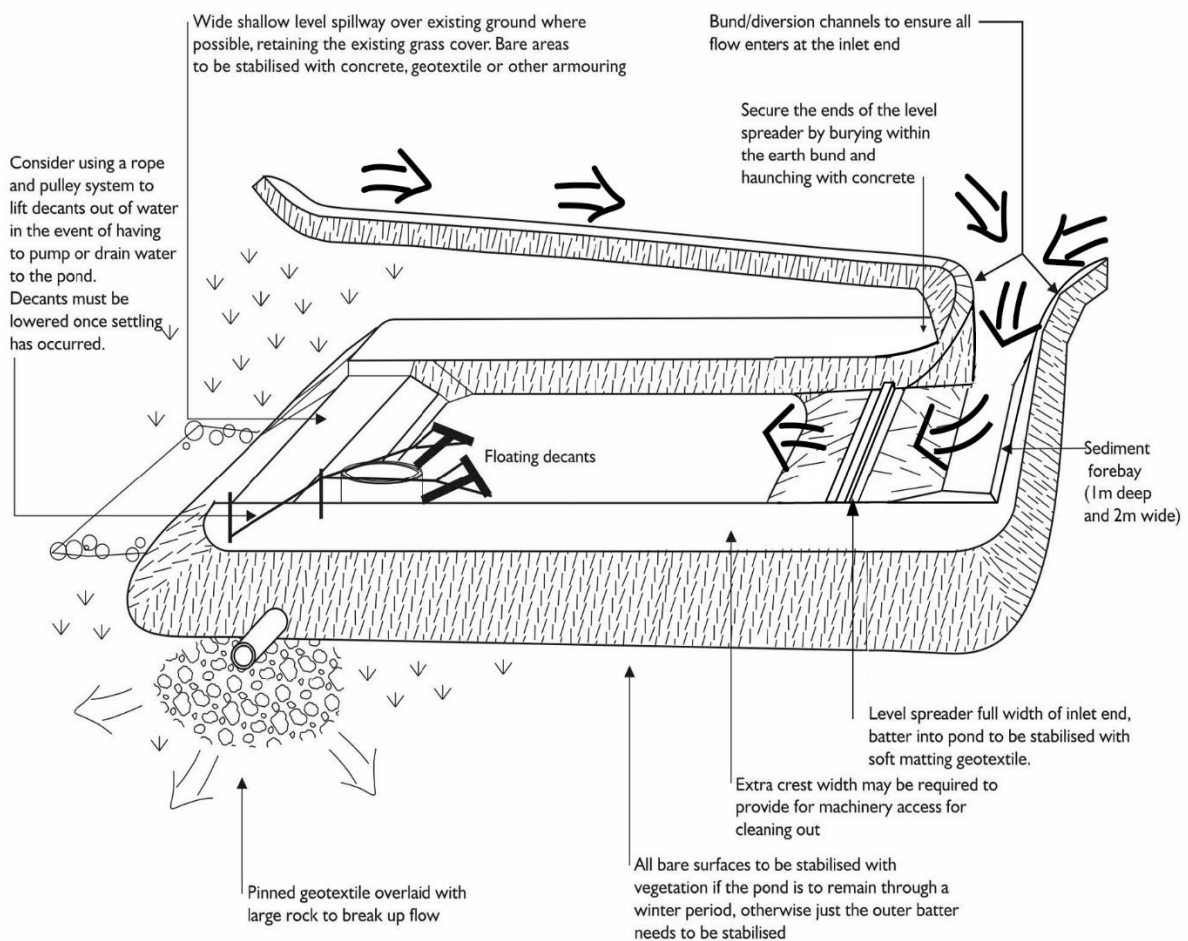

Figure 9-2 Schematic of a Sediment Retention Pond (Auckland Councils')

### 9.1.4.3 Location of the pond

The location of the sediment retention pond needs to be carefully considered in terms of the overall project. Initial considerations include:

- The available room for construction and maintenance of the pond.



- The final location of any permanent stormwater retention facilities that may be constructed at a later stage. In this respect, there may be opportunity to excavate a sediment retention pond for use during the earthworks stage in the same location, which can then be modified to form the permanent stormwater feature once works are fully stabilised.
- Whether drainage works can be routed to the sediment retention pond until such time as the site is fully stabilised. This eliminates the need to install and maintain stormwater inlet protection or other sediment controls throughout the latter stages of a development.

Consideration should also be given to where the sediment collected in the pond will be disposed of - over a reasonable time period this could be tonnes of material.

#### 9.1.4.4 Pond Volume

The general design approach is to create an impoundment of sufficient volume to capture a significant proportion of the design runoff event, and to provide still water conditions which promote the settling of suspended sediment.

There are two issues to consider in sizing ponds:

1. **Storage volume** for sediment control –the design methodology is outlined in Appendix 13.5, and
2. **Discharge rate** - to ensure that downstream stream channel erosion is not increased during construction – a standardised methodology for this is outlined in 9.1.4.10, but if required can also be calculated using the detailed design method in Appendix 13.5.

When calculating the volume of the sediment retention pond use the depth measured from the base of the sediment retention pond to the top of the primary spillway. This incorporates both the live storage and dead storage volumes (refer Figure 9-7). There should be a 300mm freeboard between the primary spillway and the emergency spillway.

Clearly show the sediment retention pond dimensions necessary to obtain the required pond volume on the site's Erosion and Sediment Control Plan (refer Chapter 6).

##### 9.1.4.4.1 Dead storage (permanent storage)

- Dead storage is the component of pond volume that does not decant and remains in the sediment retention pond. It is important for dissipating the energy of sediment laden inflows and to reduce resuspension potential.
- Ensure dead storage is 30% of the total sediment retention pond volume by positioning the lowest decant at the design height above the invert of the sediment retention pond.
- The approved decant design detailed in this guideline allows the lower decant arm to be raised as sediment deposition increases, thereby maintaining the percentage volume of dead storage.

##### 9.1.4.4.2 Live storage (decant storage)

- Live storage is the pond volume between the lowest decant outlet level and the crest of the primary spillway.
- Ensure that the live storage volume capacity is 70% of the total sediment retention pond volume.
- The decant design allows the decant system to be raised as sediment deposition increases, thereby maintaining the percentage volume of live storage.

#### 9.1.4.4.3 Shape of the pond

- Ensure the length to width ratio of the sediment retention pond is no less than 3:1 and no greater than 5:1 measured at the midslope of the SRP. The length of the sediment retention pond is measured as the distance between the inlet and the outlet (ie decant system).
- Maximise the distance between the inlet and the outlets (including the emergency spillway) to reduce the risk of short circuiting and to promote still water conditions. If this cannot be achieved by correctly positioning the inlet and outlets, install baffles to achieve the appropriate length to width ratio design.
- Ensure that the sediment retention pond has a level invert to promote the even and gradual dissipation of the heavier inflow water across the full area of the sediment retention pond.
- Ensure the pond embankment width is sufficient for digger access to allow easy removal of accumulated sediment.

#### 9.1.4.5 Depth of pond

- Sediment retention pond depths may be 1 – 2m deep, but no deeper than 2m. Deeper ponds are more likely to cause short circuiting problems during larger storm events, require specifically designed floating decant systems and could represent a safety hazard.
- The decant design in this guideline operates through a maximum live storage range of 1.5m.

#### 9.1.4.6 Baffles

Baffles are used to increase the length that flows travel within the pond to allow for more time for sediments to settle out. They are also used to reduce the effect of wind in resuspension of accumulated sediments in large ponds.

- Incorporate baffles in the sediment retention pond design where the recommended pond shape cannot be achieved or where ponds are very large (eg greater than 400m<sup>3</sup> per ha of contributing catchment).
- Extend baffles the full depth of the sediment retention pond and place them to maximise dissipation of flow energy.
- Generally, baffles are in the form of a wing to direct inflows away from the outlet and maximise the stilling zone and flow path. A series of compartments within the pond can be used to achieve this, although care should be taken to avoid creating in-pond currents and resuspension of light particulates.
- Baffles may be constructed from various materials ranging from solid shutter boards to braced geotextile curtains.

#### 9.1.4.7 Embankment

Thoroughly compact the sediment retention pond embankment, with material laid in 150mm layers and compacted to standards set out in the Nelson Tasman Land Development Manual (NTLDM).

- In a number of instances (e.g. steep slopes and/or low strength soils) specific geotechnical design and certification will be required.
- Where possible install the discharge pipes through the embankment as the embankment is being constructed.
- Fully stabilise the external batter face, by vegetative or other means, immediately after construction.
- Ensure all bare areas associated with the sediment retention pond (including internal batters) are stabilised.

#### 9.1.4.8 Forebay

- Construct a forebay with a volume equal to 10% of the design pond volume.
- The forebay should extend the full width of the pond and be a maximum of 1m in depth.
- The forebay is upstream of the level spreader.
- Access is to be maintained to the forebay at all times to allow removal of accumulated sediment.

#### 9.1.4.9 Level spreader

Incorporate a level spreader into the inlet design to spread inflow, reduce velocities and maximise the full size of the pond.

- Ensure the level spreader is level, non-erodible and spans the full width of the sediment retention pond
- A level spreader can consist of a 150mm x 50mm straight timber plank (or equivalent) laid on its edge, levelled and fastened into place with concrete, bolted through waratah or other fasteners. Timber stakes are not recommended as they usually move.



Figure 9-3 Level Spreader and Forebay

- Position the top of the level spreader 100 – 200mm above the invert of the emergency spillway. Concrete haunching should be placed at both sides of the level spreader to ensure no outflanking or undercutting.
- Combine the level spreader with a well compacted and smoothed inlet batter (no steeper than a 3:1 gradient). Lay geotextile fabric in the level spreader trench and down the inlet batter to the dead storage level. To ensure flows do not outflank the level spreader use concrete haunching at the ends.

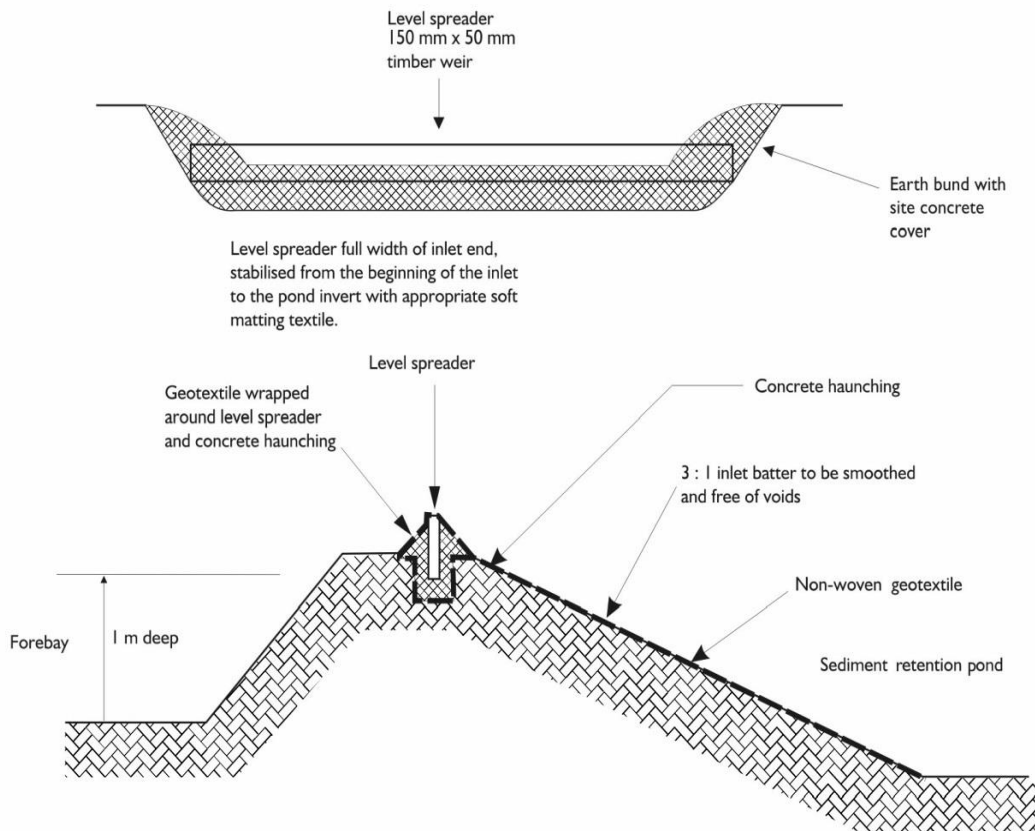

Figure 9-4 Level Spreader

#### 9.1.4.10 Dewatering devices (T-Bar Decant)

The dewatering device aims to remove the water within the upper water column –where the water is cleanest- without removing any of the settled sediment, and without removing any appreciable quantities of floating debris.

Various dewatering devices are available, however the use of a floating T-bar dewatering device is necessary in the Tasman region. This allows for the decanting of the cleaner water from the top of the water column. Substantiated performance design will need to be required for decant systems other than the floating T-bar dewatering device.

For simplicity, this guide recommends a standard T-bar decant that provides a decant rate of 4.5 litres per second per decant (refer Figure 9-6). Additional standardised decants can be added to accommodate various sized catchments (1 standardised decant per 1.5ha contributing catchment).

To create a standardised, decant that achieves a decant rate of 4.5 litres per second per decant, drill 6 rows of 10mm diameter holes at 60mm spacings (200 holes) along a 2m long decant arm.

If required, the detailed design methodology in Appendix 13.7 can be utilised to determine site-specific decant designs for any contributing catchment area.

- Single T-bar decants should be able to operate through the full live storage depth of the sediment retention pond.
- The decant design in this guideline operates through a maximum live storage range of 1.5m. For catchments of less than 1.5ha, seal off the appropriate number of holes to achieve a 3 litres/second/hectare discharge rate see Figure 9-7.
- If two decant systems are required (refer figure 9-8), ensure the lower T-bar decant operates through the full live storage depth of the sediment retention pond. The upper T-bar decant is to operate through the upper 50% of the live storage depth only.



Figure 9-5 Sediment retention pond detail showing multiple decants

- If three decant systems are to be used (Figure 9-8), then the lower T-bar decant operates through the full live storage depth and the second T-bar decant through the upper two thirds of live storage depth of the sediment retention pond. The upper T-bar decant operates through the upper one third of live storage depth of the sediment retention pond.
- Ensure that the T-bar decant float is securely fastened with steel strapping directly on top of the decant arm and weight it to keep the decant arm submerged just below the surface through all stages of the decant cycle. This will also minimise the potential for blockage of the decant holes by floating debris. The most successful method found to date is to weight the decant arm by strapping a 1.8m long waratah between the float and the decant (approximately 4kg of weight).
- Position the T-bar decant at the correct height by tying 5mm nylon cord through decant holes at either end of the decant arm and fastening it to waratahs driven in on either side of the decant.
- Use a flexible, thick rubber coupling to provide a connection between the decant arm and the primary spillway or discharge pipe. To provide sufficient flexibility for lower decant arms install two couplings. Fasten the flexible coupling using strap clamps, glue and screws.
- Where a concrete riser decant system is utilised, ensure the lower decant connection is positioned on an angle upwards from the horizontal so as to split the operational angle that the decant works through. This will reduce the deformation force on the coupling used.
- Rope and pulley systems installed on the decants allow for easy maintenance of discharge holes and also allows for discharge from ponds to be temporary stopped if needed (for example to prevent water pollution while cleaning up non-sediment spills that enter pond).



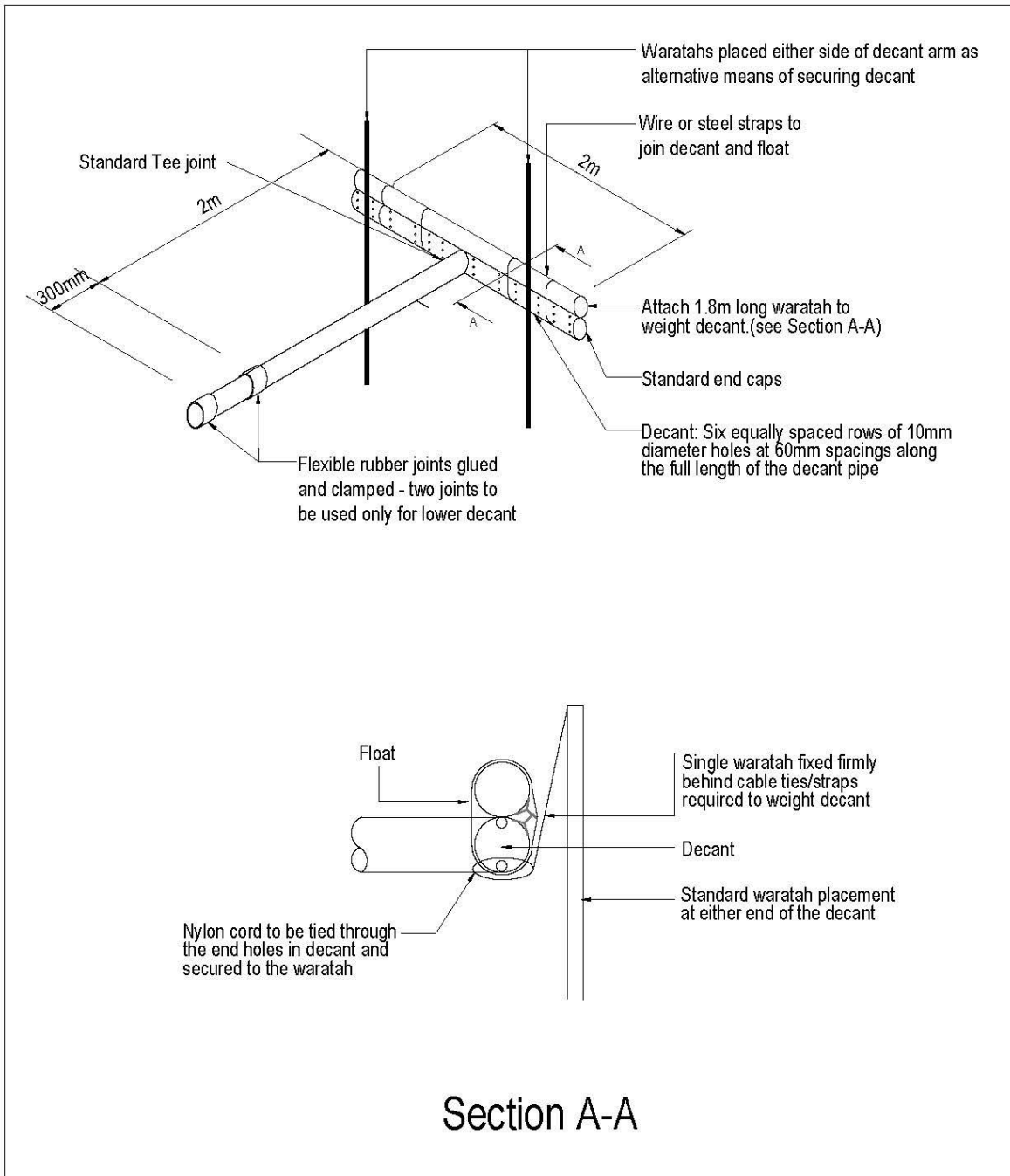

Figure 9-6 Sediment Retention Pond – Decant Detail (Auckland Councils')

Schematics of decant systems in sediment retention ponds for catchment areas of less than 1.5ha, 1.5 to 3ha and 3ha to 5ha are shown in the following figures.

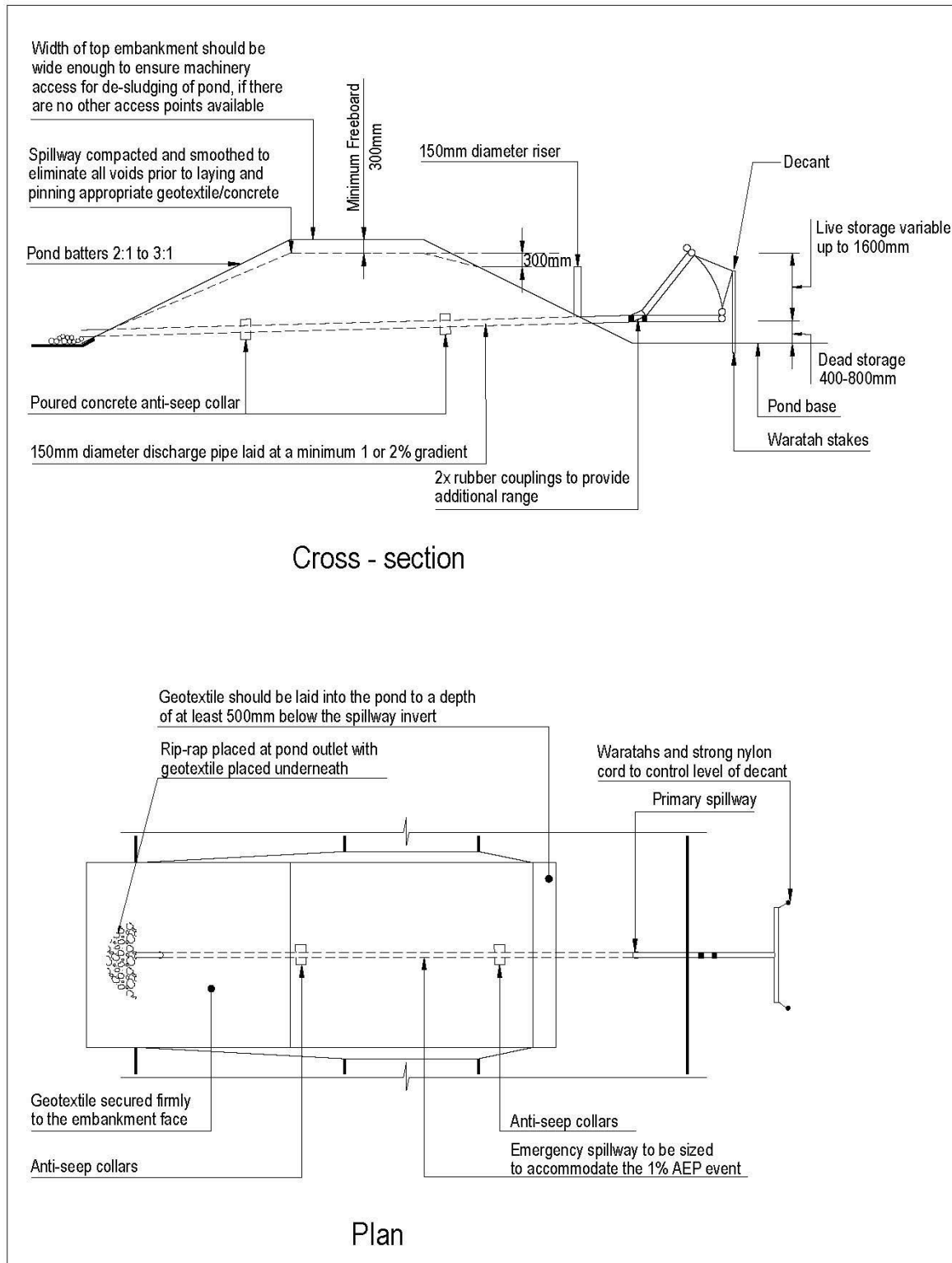

Figure 9-7 Sediment Retention Pond T-bar decant system for Catchments less than 1.5 ha

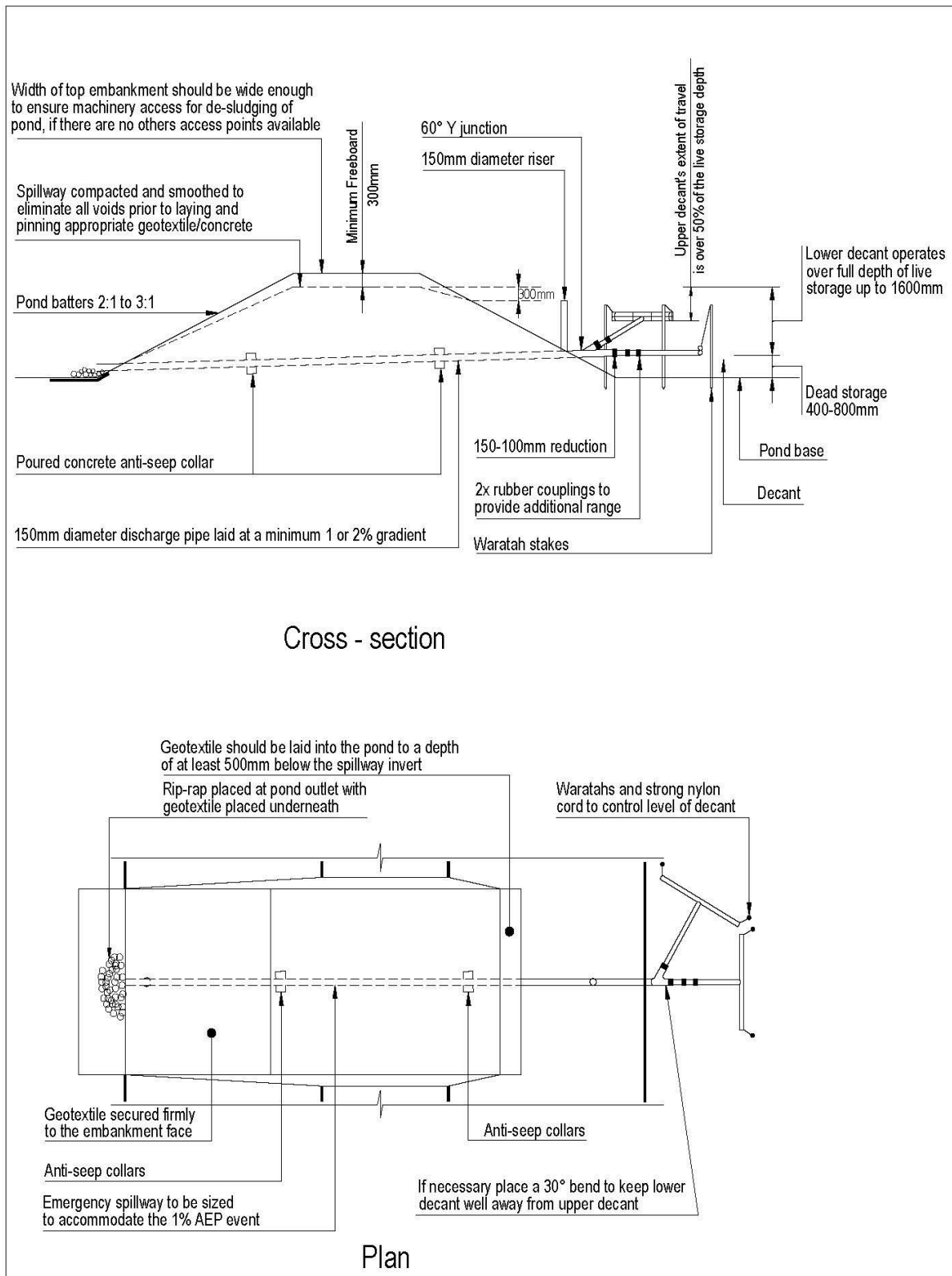

Figure 9-8 Sediment Retention Pond T-bar decant system for Catchments between 1.5 – 3 ha

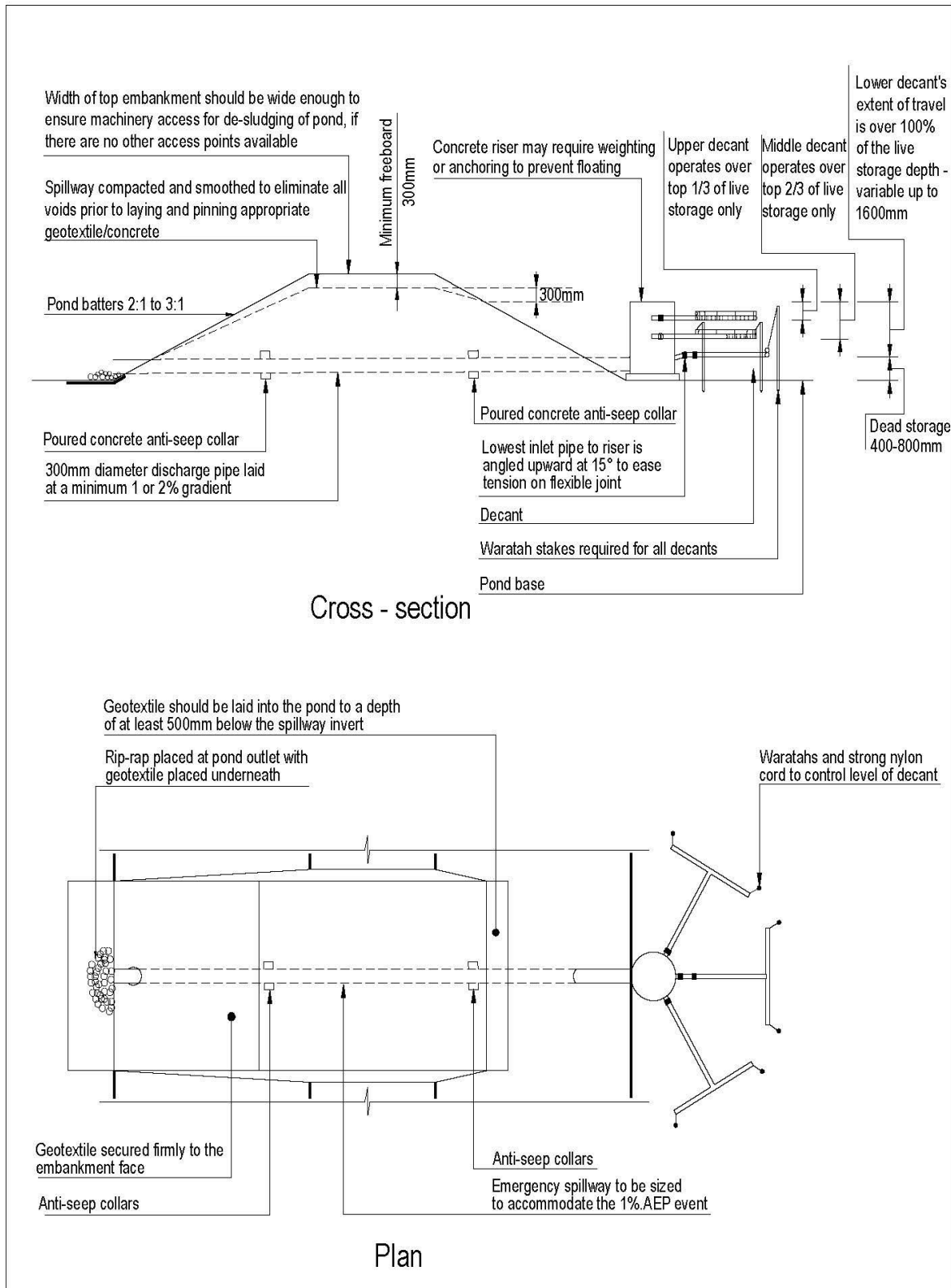

Figure 9-9 Sediment Retention Pond T-bar decant system for Catchments Between 3 – 5 ha

#### 9.1.4.11 Primary spillway

For catchments up to 1.5ha, decant flows can be piped using the same diameter piping as the decant system (100mm PVC smooth bore) directly through the sediment retention pond wall to discharge beyond the toe of the sediment retention pond wall.

For catchments larger than 1.5ha the sediment retention pond requires a piped primary spillway (refer Figure 9-8 and Figure 9-9).

- For contributing catchments between 1.5 and 3ha in area, use a discharge and primary spillway pipe diameter of 150mm.
- Where contributing catchments are 3ha or greater and/or the long term stability of the sediment retention pond emergency spillway is questionable (for example, built in fill) incorporate a concrete manhole riser and larger diameter pipe outlet as a primary spillway sufficient to accommodate the 5% AEP rainfall event.
- If the sediment retention pond is to remain online during a work stoppage and the contributing catchment is fully stabilised, ensure accumulated sediments have been removed and disconnect the T-bar decant to reduce the frequency of emergency spillway activation and consequent erosion.
- Where a primary spillway upstand riser is used, place the top of the riser a minimum 300mm lower than the emergency spillway crest. Ensure the riser and the discharge pipe connections are all completely watertight.
- Where possible, install the piping through the embankment as the embankment is being constructed.

#### 9.1.4.12 Pipe Outlets

Lay the discharge pipe at a 1 – 2% gradient, compact the fill material around it using a machine compactor and incorporate anti-seep / filters collars with the following criteria:

- Anti-seep collars
  - Install collars around the pipe to increase the seepage length along the pipe with a spacing of approximately 10m;
  - The vertical projection of each collar is 1m; ensure all anti seep collars and their connections are watertight.
- Filter collars
  - The filter collar, as shown in figure 9-10 , should be positioned along the pipe ensuring they start just after half way through the dam where  $h = 2/3 H$ , where H is the embankment height.
  - The filter collar should be 1m x 1m x 1m and allow for sufficient compaction around the pipe. Specific design is required if the pipe diameter is greater than 200mm.
  - The filter material should be medium to coarse sand, e.g. a D15 = 0.7mm is anticipated to provide a good filter. Seek professional advice if there is any doubt about the compatibility of filter materials with the local ground conditions or embankment fill.
  - The filter sands should be compacted sufficiently wet to optimize compaction and avoid saturation collapse.
  - The filter drain should continue to the outlet to allow for drainage from the filter collar to the downstream toe.
  - The outlet should allow for seepage from the filter drain and be stabilized against erosion and dissipate energy, e.g. rock fill riprap at the outlet with a heavy-duty geotextile filter fabric.



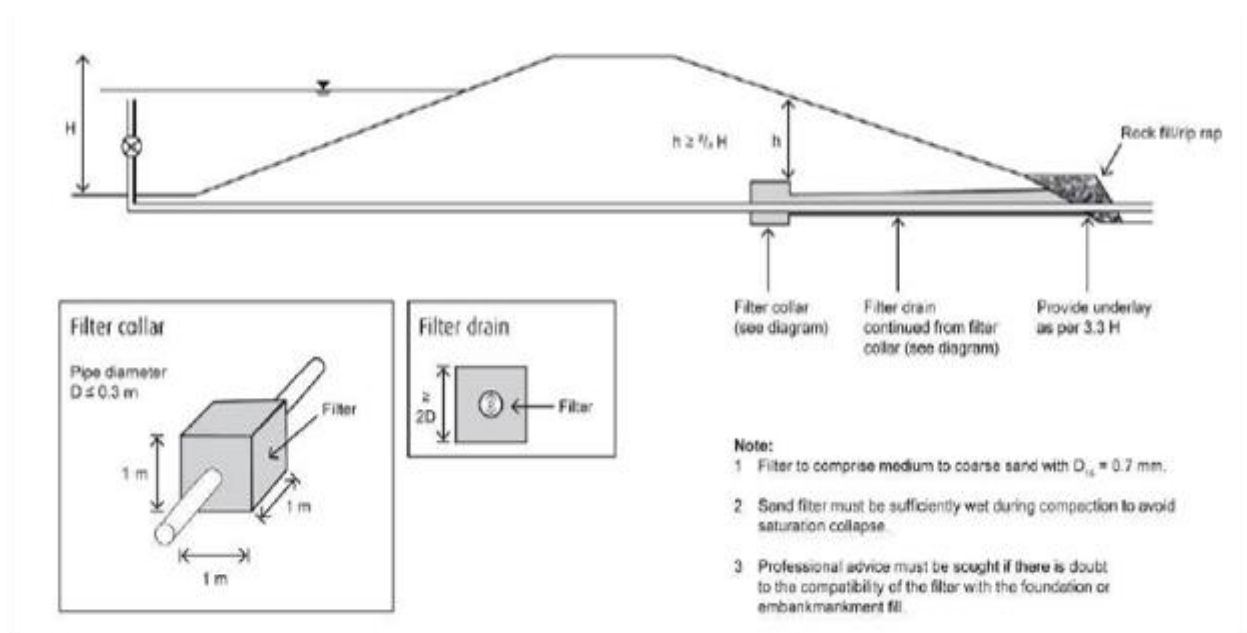

Figure 9-10 Filter Collar Schematic Detail

#### 9.1.4.13 Emergency spillway

An emergency spillway is essential for all sediment retention ponds. Emergency spillways should be capable of accommodating the 1% AEP event without eroding. If the spillway is vegetated only, velocities during the 1% event should be less than 1.5m/s. The design storm event should use the methodology outlined in Appendix 13.7.

- The outer emergency spillway crest and batter requires a very high standard of stabilisation with the fill material of the spillway batter well compacted.
- Construct the emergency spillway as a stabilised trapezoidal cross section with a minimum bottom width of 6m or the width of the pond floor, whichever is the greater.
- Construct the invert of the emergency spillway with a minimum of 300mm freeboard below the embankment height.
- When utilising geotextile for emergency spillway stabilisation purposes, the batter face needs be smooth, and all voids eliminated to prevent damage of the fabric.
- If geotextile is used, a soft needle punched geotextile is laid first and then covered with a strong woven low permeability geotextile. Ensure the geotextile is pinned at 0.5m centres over the full area of the emergency spillway.
- Where possible, construct emergency spillways in well vegetated, undisturbed ground (not fill) and discharge over long grass.
- If the emergency spillway is constructed on bare soil, provide complete erosion protection by means such as grouted riprap, asphalt, erosion matting/ geotextile or concrete.
- Construct the emergency spillway with a minimum of 300mm freeboard height above the primary spillway.

### 9.1.5 Construction specifications

Sediment retention ponds have the following construction specifications:

- Before building a sediment retention pond, install sediment controls such as Silt Fences (section 9.2) below the construction area and maintain them to a functional standard until the sediment retention pond batters are fully stabilised in accordance with the practices outlined in section 9.3.
- Under areas of proposed fill, clear topsoil or other unsuitable material down to competent material. Large fill embankments may need to be keyed in.
- Use only approved fill.
- Place and compact fill in layers as per the engineer's specifications. In a number of instances (e.g. steep slopes and/or low strength soils) specific geotechnical design and certification will be required.
- Do not place pervious materials such as sand or gravel within the fill material.
- Construct fill embankments approximately 10% higher than the design height to allow for settlement of the material.
- Construct the emergency spillway.
- Install and stabilise the level spreader.
- Securely attach the decant system to the horizontal pipe work. Make all connections watertight. Place any manhole riser on a firm foundation of concrete (preferred) or impervious compacted soil.
- Do not place pervious material such as sand or scoria around the discharge pipe or the anti-seep collars/ filters.
- Protect inlet and outlet with suitable geotextile fabric.
- Provide an all-weather access track for maintenance.
- Check sediment retention pond freeboard and spillway elevations for differential settlement and rectify as necessary.
- Stabilise both internal and external batters with vegetation and the emergency spillway in accordance with the site's approved ESCP.
- Undertake an As-Built assessment at the completion of construction to check against the design. If there are any discrepancies rectify immediately.



Figure 9-11 Construction of a Sediment Retention Pond

### 9.1.6 Maintenance

Sediment retention ponds have the following maintenance requirements:

- Clean out sediment retention ponds before the volume of accumulated sediment reaches 20% of the forebay volume. To assist in gauging sediment loads, a staff height gauge will assist with knowing when this volume is achieved. If sediment accumulates within the main body of the SRP this will also need to be removed.
- Clean out sediment retention ponds with high capacity sludge pumps, or with excavators (long reach excavators if needed) loading onto sealed tip trucks or to a secure area onsite.

- The ESCP should identify disposal locations for the sediment removed from the sediment retention pond. Deposit the sediment in such a location so that it does not lead to a direct discharge to receiving environments. Stabilise all disposal sites as required and approved in the site's ESCP.
- Clean out the forebay as necessary to maintain maximum efficiency.
- Inspect sediment retention ponds every day and before every forecasted rainfall event.
- Inspect for correct operation after every runoff event and at intervals during any sustained rain event.
- Immediately repair any damage to sediment retention ponds caused by erosion or construction equipment.

### 9.1.7 Decommissioning

In decommissioning sediment retention ponds consider the following:

- Install a silt fence or other device below the sediment retention pond prior to decommissioning the pond.
- Take the pond offline (ie divert water away from pond inlet).
- Dewater the pond ensuring sediment laden water is treated appropriately.
- Remove and correctly dispose of all accumulated sediment. The methodology required for this will depend on the specific situation:
  - Removal can be done by leaving the sediments to dry and remove by digger or using a sucker truck while sediments are in a slurry form.
  - For ponds located near waterbodies, all accumulated sediments should be removed from the pond and buried away from any waterbodies in areas with low erosion risk to avoid the fine sediments being entrained in future storm events.
  - If sediments are to be left in place and buried, they can be stabilised using calcium hydroxide (slaked lime).
- Remove geotextile fabric, concrete, pipe and other construction materials.
- Backfill the pond and compact soil, re-grade as required or reform as permanent stormwater feature if this has been approved in plans.
- Stabilise all exposed surfaces.

## 9.2 Silt fences

### 9.2.1 Definition and purpose

A silt fence is a temporary barrier of woven geotextile fabric that is used to capture predominantly coarse sediments carried in sheet flow. Silt fences temporarily impound sediment laden runoff, reducing velocities and allowing sediment to settle out of the water.

The purpose of a silt fence is to detain flows from runoff so that deposition of transported sediment can occur through settlement.



Figure 9-12 Silt fence with returns to reduce lateral water movement

### 9.2.2 Conditions where practice applies

Silt fences apply when:

- Contributing catchments are less than 0.5ha. Above this careful consideration of design and alternative measures are required.
- Intercepting sheet flow.
- On low gradient sites for confined areas, such as short steep batter fills, house construction sites and along watercourses. (Do not install silt fences across watercourses or in areas of concentrated flows).
- To delineate the limit of disturbance on an earthworks site such as riparian areas or bush reserves.

### 9.2.3 Limitations

Silt fences have the following limitations:

- Silt fences do not capture many soil particles finer than 0.02mm in diameter (for example fine silts and clays) due to the short detention time of water behind the silt fence and relatively large pore size of most fabrics.
- The pores in the silt fence fabric become clogged relatively quickly with fine textured sediments, which result in the fabric becoming impermeable. As a result additional reinforcing (such as chain link fence – super silt fence refer section 9.3 might be required).
- Relative to other measures they can be high cost.
- Only used for sheet flow, not concentrated flow. Do not use silt fences as checks dams in channels (to reduce velocities) or place them where they will intercept concentrated flow.
- Silt fences should be used a part of a treatment train approach.

## 9.2.4 Key design criteria

Design Silt fences using the criteria below:

- Ensure silt fence height is a minimum 400mm above ground level.
- Place supporting posts/waratahs for silt fences no more than 2 metres apart unless additional support is provided by tensioned wire (2.5mm HT) along the top of the silt fence. Ensure supporting posts/waratahs are embedded a minimum of 400 mm into the ground.
- Where a strong woven fabric is used in conjunction with a wire support, the distance between supporting posts can be extended up to 4 metres. Double the silt fence fabric over and fasten to the wire and posts with wire ties or cloth fastening clips at 150mm spacings.
- Always install silt fences along the contour. Where this is not possible or where there are long sections of silt fence, install short silt fence returns (refer Figure 9-13 projecting upslope from the silt fence to minimise concentration of flows. Silt fence returns should be a minimum 2 metres in length, can incorporate a tie back and are generally constructed by continuing the silt fence around the return and doubling back, eliminating joins.
- Join lengths of silt fence by doubling over fabric ends around a wooden post or batten or by stapling the fabric ends to a batten and butting the two battens together (refer Figure 9-13).
- Install silt fence wings at either end of the silt fence projecting upslope to a sufficient height to prevent outflanking.
- Where impounded flow may overtop the silt fence, crossing natural depressions or low points, make provision for a riprap splash pad or other outlet protection device.
- Maximum slope lengths, spacing of returns and angles for silt fences are shown in Table 9-1.

Table 9-1 Silt fence design criteria

Slope steepness %	Slope length (m) (Maximum)	Spacing of returns (m)	Silt fence length (m) (Maximum)
Flatter than 2%	Unlimited	N/A	Unlimited
2 – 10%	40	60	300
10 – 20%	30	50	230
20 – 33%	20	40	150
33 – 50%	15	30	75
> 50%	6	20	40

- Where water may pond regularly behind the silt fence, provide extra support for the silt fence with tie backs from the silt fence to a central stable point on the upward side. Extra support can also be provided by stringing wire between support stakes and connecting the filter fabric to this wire.
- The geotextile fabric cloth should be appropriate for purpose (including strength and opening size) and installed following the manufacturer's specifications.



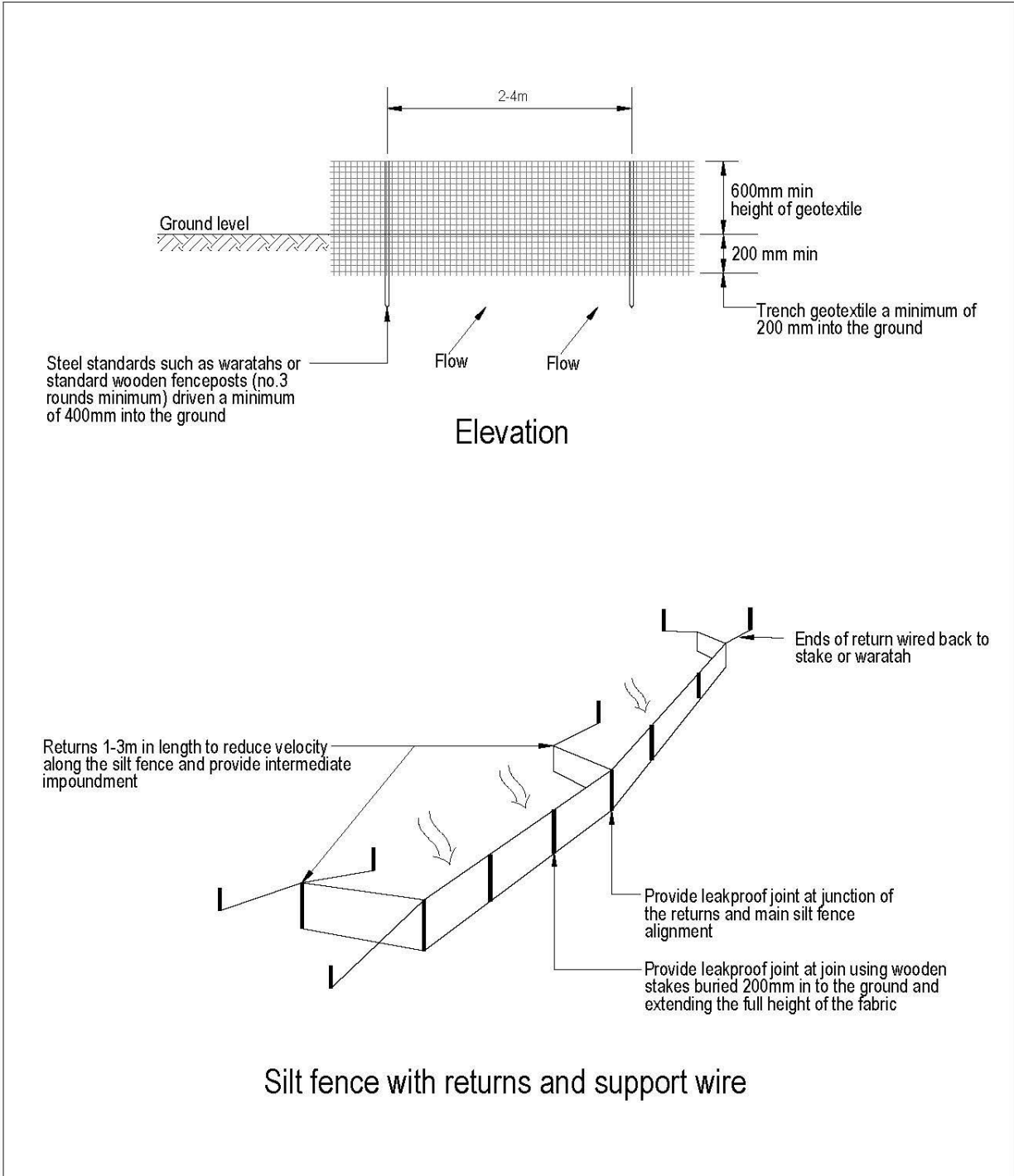
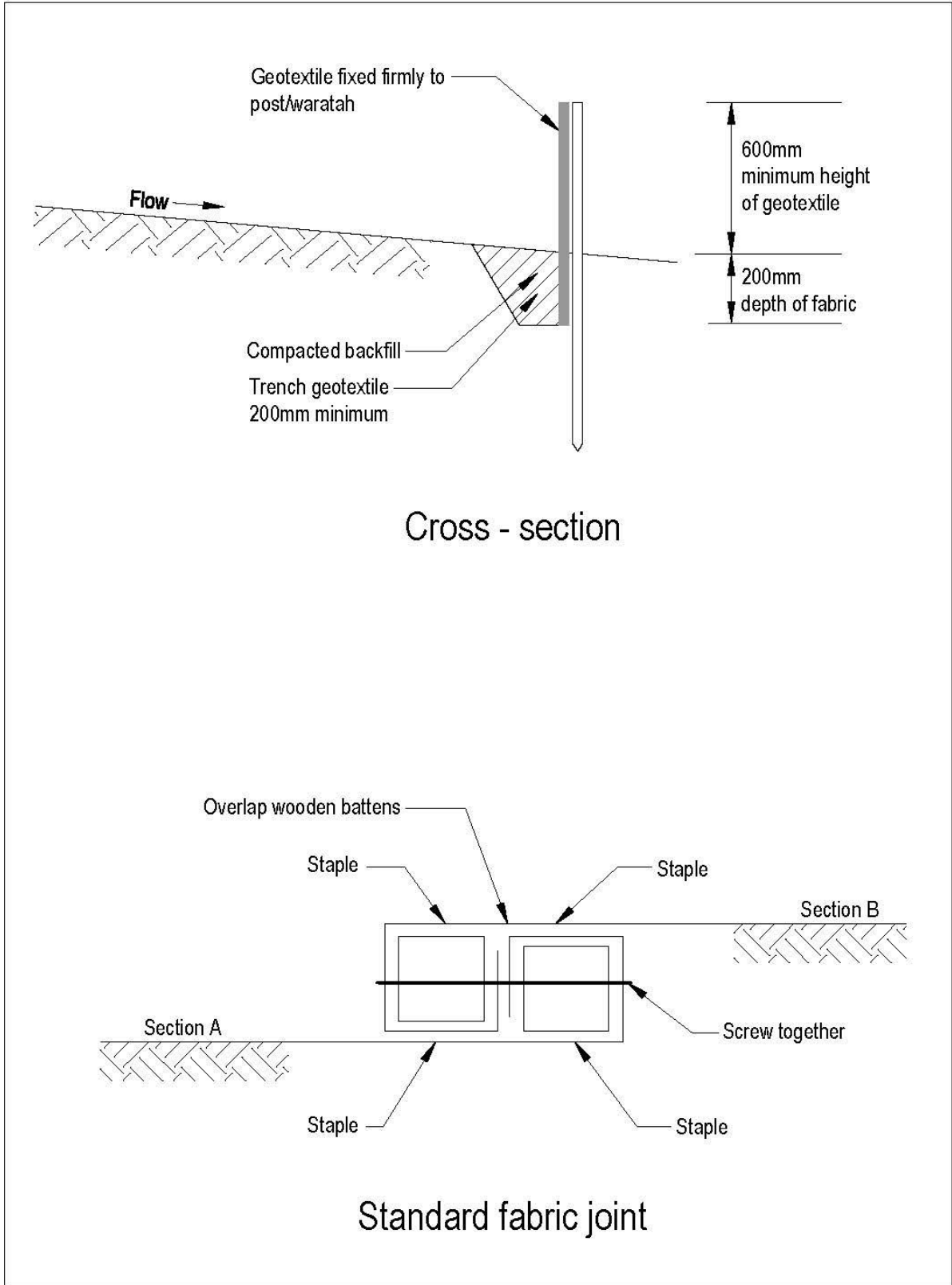
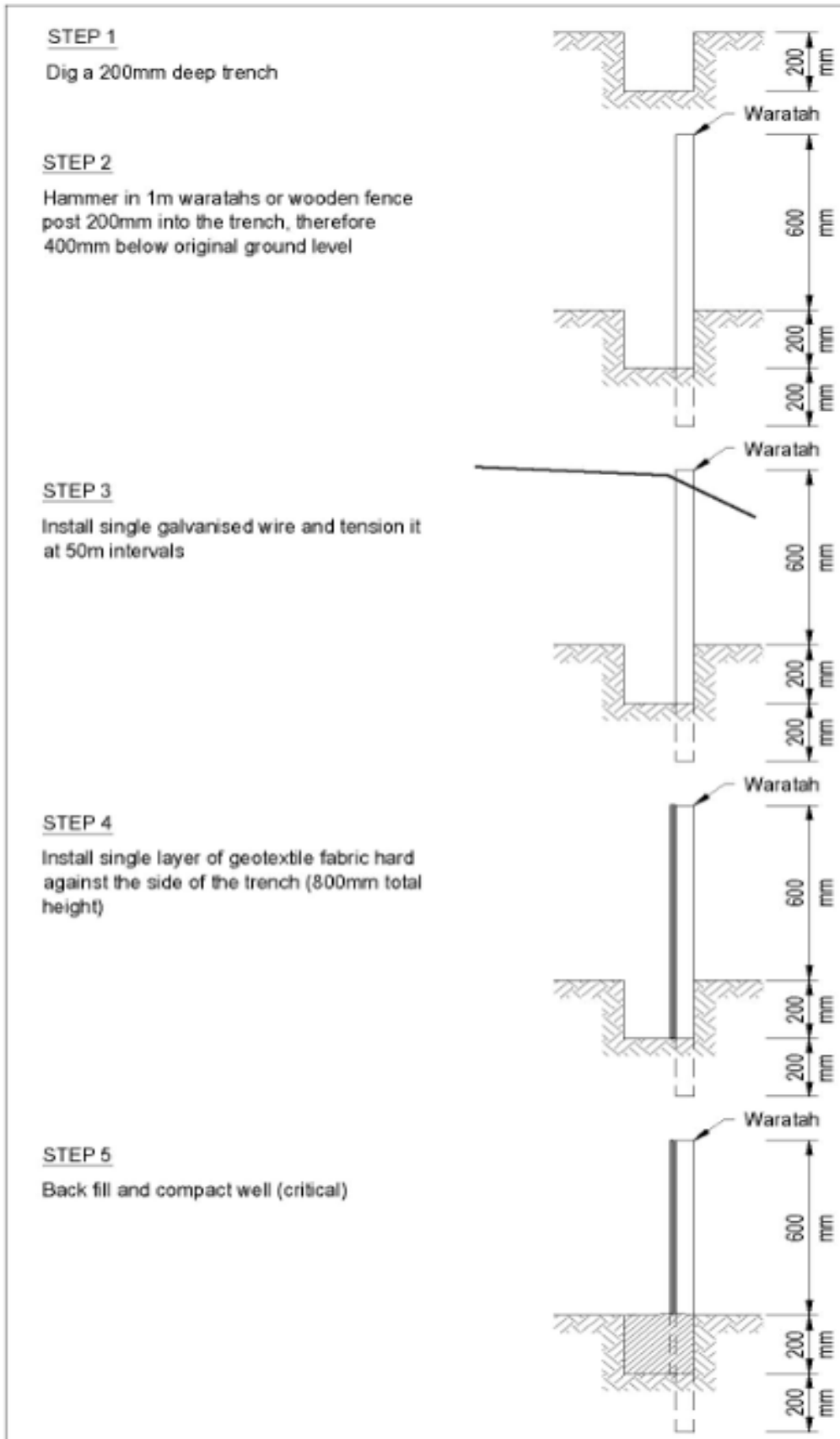

Figure 9-13 Schematic of a Silt Fence





### 9.2.5 Construction

When constructing a silt fence, apply the following:

- Use silt fence material appropriate to the site conditions and in accordance with the manufacturers' specifications.
- Always install silt fences along the contour.
- Excavate a trench a minimum of 100mm wide and 200mm deep along the proposed line of the silt fence.
- Improve by adding a 200mm fence return at right angles on the base towards the direction of the flow this strengthens the fences it is currently not shown on the diagrams.
- Use supporting posts of tanalised timber a minimum of 50mm square, or steel waratahs at least 0.8m in length.
- Ensure the posts are driven to a depth of at least 400mm.
- Install the support posts/waratahs on the downslope edge of the trench and silt fence fabric on the upslope side of the support posts/waratahs to the full depth of the trench, then backfill the trench with compacted soil.
- If required reinforce the top of the silt fence fabric with a support made of high tensile 2.5mm diameter galvanised wire. Tension the wire using permanent wire strainers attached to angled waratahs at the end of the silt fence.
- Where ends of silt fence fabric come together, ensure they are overlapped, folded and stapled/screwed to prevent sediment bypass.

### 9.2.6 Maintenance

Silt fences require the following maintenance:

- Inspect silt fences at least once a week and after each rainfall.
- Check for damage including rips, tears, bulges in the fabric, broken support wires, loose posts/waratahs, overtopping, outflanking, undercutting, and leaking joints in fabric.
- Make any necessary repairs as soon as identified. Tears in silt fences need to be fixed as per Standard Fabric Joint as above.
- Remove sediment when bulges occur or when sediment accumulation reaches 20% of the fabric height.
- Remove sediment deposits as necessary (prior to 20% of fabric height) to continue to allow for adequate sediment storage and reduce pressure on the silt fence.
- Dispose of sediment to a secure area to ensure that it does not discharge to the receiving environment.

### 9.2.7 Decommissioning

In decommissioning silt fences consider the following:

- Do not remove silt fence until the catchment area has been appropriately stabilised.
- Remove and dispose of accumulated sediment to an appropriate location.
- Backfill trench, re-grade and stabilise the disturbed area.

## 9.3 Super silt fence

### 9.3.1 Definition and purpose

A super silt fence is a temporary barrier of woven geotextile fabric over a chain link fence that is used to capture predominantly coarse sediments carried in sheet flow.

Super silt fences temporarily impound sediment laden runoff, reducing velocities and allowing sediment to settle out of the water.

The purpose of a super silt fence is to detain flows from runoff so that deposition of transported sediment can occur through settlement.

### 9.3.2 Conditions where practice applies

Super silt fences apply:

- Where debris or sediment volumes are likely to exceed the capacity for standard silt fences
- Where contributing catchments are less than 0.5ha. Above this careful consideration of design and alternative measures is required
- A barrier is needed to collect and hold debris and soil, preventing the material from entering critical areas, watercourses and streets.
- Can be used where the installation of an earth or topsoil bund would destroy sensitive areas such as bush and wetlands.
- Should be placed as close to the contour as possible. No section of the fence should exceed a grade of 5% (20:1, 2.86°) for a distance of more than 15m.

### 9.3.3 Limitations

Super silt fences have the following limitations:

- Super silt fences do not capture many soil particles finer than 0.02mm in diameter (for example fine silts and clays) due to the short detention time of water behind the super silt fence and relatively large pore size of most fabrics.
- The pores in the super silt fence fabric become clogged relatively quickly with fine textured sediments, which result in the fabric becoming impermeable.
- Relative to other measures they can have a high cost.
- Only used for sheet flow, not concentrated flow. Do not use super silt fences as checks dams in channels (to reduce velocities) or place them where they will intercept concentrated flow.
- Super silt fences should be used a part of a treatment train approach.



Figure 9-14 Super Silt Fence



### 9.3.4 Key design criteria

Design Super Silt fences using the criteria below:

- When considering super silt fence installation for larger catchments (greater than 0.5ha), carefully consider the specific site conditions and other alternative control measures available.
- Limits imposed by ultraviolet light affect the stability of the fabric and will dictate the maximum period that the super silt fence may be used.
- Where ends of the geotextile fabric come together, overlap, fold and staple the fabric ends to prevent sediment bypass (refer Figure 9-15).
- Base the length of the super silt fence on the limits shown in Table 9-2.
- Improve by adding a 200mm fence return at right angles on the base towards the direction of the flow this strengthens the fences it is currently not shown on the diagrams.

Table 9-2 Super silt fence design criteria

Slope steepness %	Slope length (m) (Maximum)	Super silt fence length (m) (Maximum)
0 – 10%	Unlimited	Unlimited
10 – 20%	60	450
20 – 33%	30	300
33 – 50%	30	150
> 50%	N/A	N/A

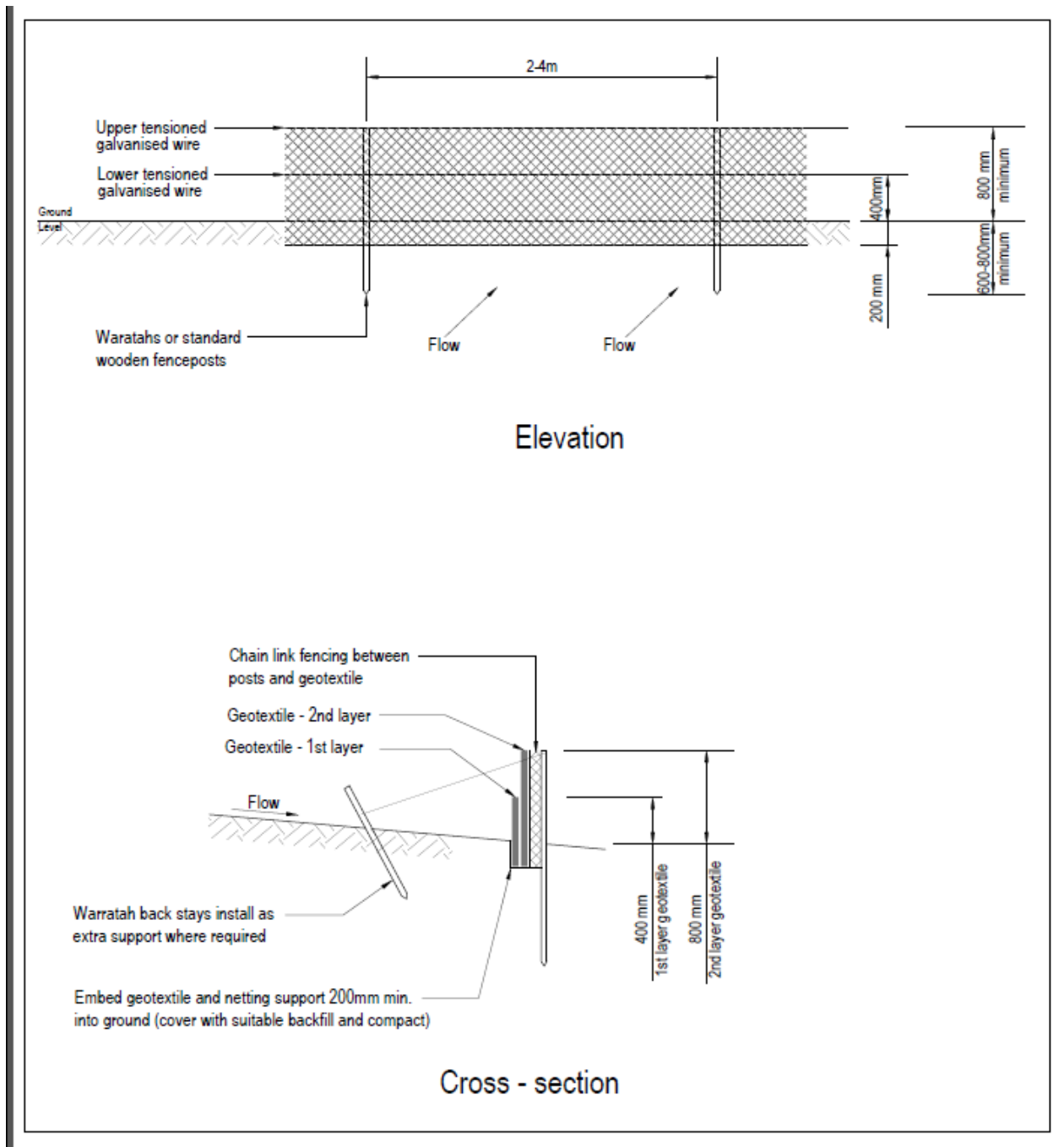
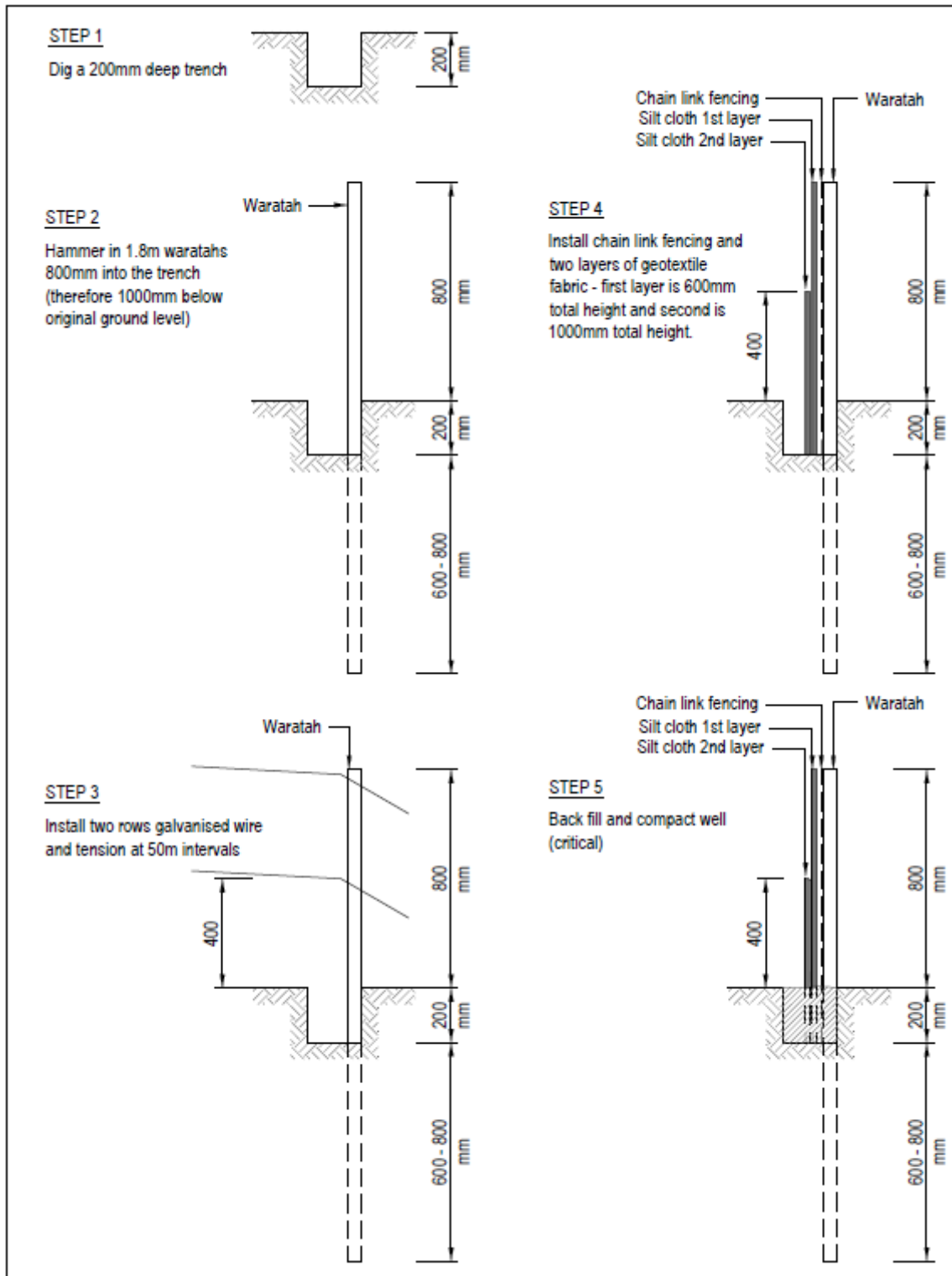

Figure 9-15 Schematic of a Super Silt Fence



- The geotextile fabric cloth should be appropriate for purpose (including strength and opening size) and installed following the manufacturer's specifications.

### 9.3.5 Construction

When constructing a super silt fence, apply the following:

- Use super silt fence material appropriate to the site conditions and in accordance with the manufacturers' specifications.
- Always install super silt fences along the contour.
- Excavate a trench a minimum of 100mm wide and 200mm deep along the proposed line of the super silt fence.
- Use supporting posts of tanalised timber (No. 3 rounds, No. 2 half rounds), or steel waratahs at least 1.8m in length.
- While there is no need to set the posts in concrete, ensure the 1.8m long posts are driven to a depth of 1metre.
- Install tensioned galvanised wire (2.5 mm HT) at 400mm and again at 800mm above ground. Tension the wire using permanent wire strainers attached to angled waratahs at the end of the super silt fence.
- Secure chain link fence to the fence posts with wire ties or staples, ensuring the chain link fence goes to the base of the trench.
- Fasten two layers of geotextile fabric securely to the super silt fence with ties spaced every 60cm at the top and mid-section of the super silt fence.
- Place the two layers of geotextile fabric to the base of the trench (a minimum of 200mm into the ground and 200mm upslope) and place compacted backfill back to the original ground level.
- When two sections of geotextile fabric adjoin each other, ensure they are doubled over a minimum of 300mm, wrapped around a batten and fastened at 75mm spacings to prevent sediment bypass.

### 9.3.6 Maintenance

Super silt fences require the following maintenance:

- Inspect super silt fences at least once a week and after each runoff event.
- Check for damage including rips, tears, bulges in the fabric, broken support wires, loose posts/waratahs, overtopping, outflanking, undercutting, and leaking joins in fabric.
- Make any necessary repairs as soon as identified.
- Remove sediment when bulges occur or when sediment accumulation reaches 20% of the fabric height.
- Remove sediment deposits as necessary (prior to 20% of fabric height) to continue to allow for adequate sediment storage and reduce pressure on the super silt fence.
- Dispose of sediment to a secure area to ensure that it does not discharge to the receiving environment.

### 9.3.7 Decommissioning

In decommissioning super silt fences consider the following:

- Do not remove the super silt fence until the catchment area has been appropriately stabilised.
- Remove and dispose of accumulated sediment to an appropriate location.
- Backfill trench, re-grade and stabilise the disturbed area.

## 9.4 Decanting earth bund

### 9.4.1 Definition and purpose

Decanting earth bunds are designed as a miniature SRPs for smaller catchment areas.

The purpose of a decanting earth bund is to intercept sediment laden runoff and reduce the amount of sediment leaving the site by incorporating a device to dewater the bunded area at a rate that will allow suspended sediment to settle out before runoff is discharged.



Figure 9-16 Decanting Earth Bund

### 9.4.2 Conditions where practice applies

Decanting earth bunds can be constructed:

- On small sites where contributing catchment sizes and available area make sediment detention ponds impractical.
- For controlling runoff from small areas (less than 0.3ha) that are isolated from the main site controls because of site layout or because of site infrastructure, such as roading or drainage, restricting flow to the main site controls.

### 9.4.3 Limitations

Decanting earth bunds have the following limitations:

- Decanting earth bunds capture and treat slightly finer soil particles than silt fences but are not as effective in sediment removal as sediment retention ponds.
- Short circuiting can occur because they generally do not have a defined inlet.
- They are usually more effective on flatter slopes where runoff velocities are less.
- Recommended maximum catchment of 0.3ha.

### 9.4.4 Key design criteria

When designing decanting earth bunds consider the following criteria:

- Decanting earth bunds need a constructed outlet structure and emergency spillway as designed for sediment retention ponds (refer section 9.1.4).
- Floating decants must be installed on all DEBs.
- Decanting earth bund volumes are sized in accordance with the methodology outlined in Appendix 13.5.
- The impoundment area of the decanting earth bund is to be level and have a length to width ratio for the main inflows of between 3:1 and 5:1. A diversion bund may be required to achieve this.
- The maximum height of the decanting earth bund to the invert of the spillway should be 1 metre.
- The decanting earth bund is to have a minimum base width of 3 metres and a maximum batter grade of 1:1.
- Particular attention needs to be given to soil type, and need for the design and installation of an anti-seep or filter collar (refer pond design section 9.1.4).



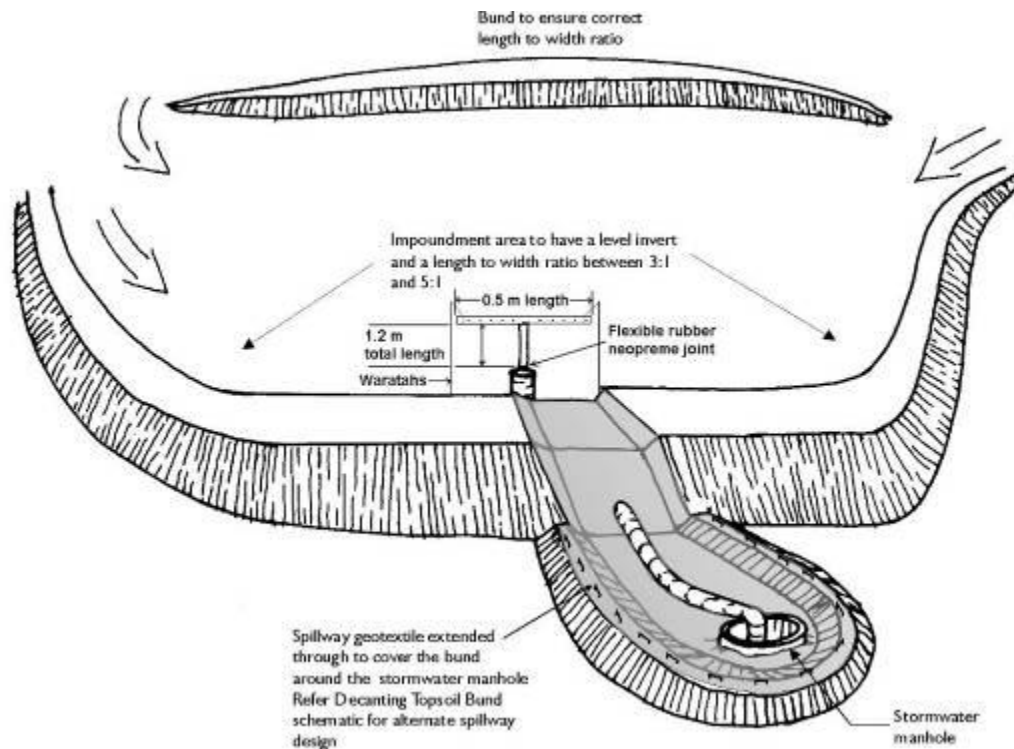

Figure 9-17 Decanting Earth Bund with a Floating Decant

#### 9.4.5 Construction

Consider the following when constructing decanting earth bunds:

- Build decanting earth bunds along the contour to obtain required volumes.
- Remove all organic material and vegetation before construction.
- The decanting earth bund is to be keyed into the existing ground to a minimum depth of 0.3 metres.
- The decanting earth bund is to be made with a clay-silt mix of suitable moisture content to achieve a reasonable compaction standard (90%). It is considered that this can be achieved, in most instances, by track rolling over 150 - 200 mm layers. Particular care is required to achieve good compaction around the outlet pipe that passes through the bund to avoid seepage and potential failure.
- Install a 150 mm diameter non-perforated outlet pipe through the bund. This is to discharge to a stable erosion-protected area or stormwater system.
- A T-Bar decant should be a 100mm diameter PVC pipe, 0.5 metres long with 20 equally spaced holes of 10mm diameter to achieve a discharge rate of 3 litres/sec/ha of contributing catchment.
- A sealed PVC pipe (with endcaps) is placed on top of the decant to provide buoyancy.



Figure 9-18 Floating Decant in DEB

Use a flexible thick rubber coupling to provide a connection between the decant arm and the discharge pipe. To provide sufficient flexibility where needed, install two couplings. Fasten the flexible coupling using strap clamps, glue and screws.

- The decant is fastened to two waratahs by way of a nylon cord to the correct height.
- Provide an emergency spillway to a stabilised outfall 150mm above the level of the top of the decanting pipe. This can be a trapezoidal spillway with a minimum invert length of 2 metres which is smooth, has no voids and is lined with a soft needle punched geotextile to the stabilised outfall. Ensure the geotextile is pinned at 0.5 metre centres.
- The emergency spillway is to have a minimum freeboard of 250mm, i.e. between the invert of the spillway to the lowest point of the top of the bund.
- Undertake an As-Built assessment at the completion of construction to check against design. If there are any discrepancies rectify immediately.

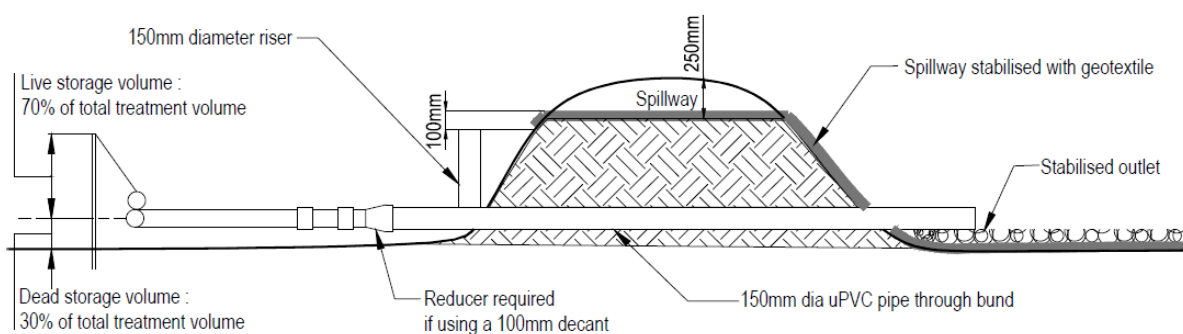

Cross - section

Figure 9-19 Cross-section Decanting earth bund

#### 9.4.6 Maintenance

Decanting earth bunds require the following maintenance requirements:

- Inspect decanting earth bunds at least once a week and after each runoff event.
- Check for damage including:
  - Spillway is secure and functional
  - Erosion at outlet, remedy if required or look at diverting outlet
  - Damage to decant and fittings
  - Seepage through embankment, or along outlet pipe
  - Blockages to holes in decants.
- Make any necessary repairs as soon as identified.
- Remove sediment when sediment accumulation reaches 20% of banded volume.
- Dispose of removed sediment to a secure area to ensure that it does not discharge back into the decanting earth bund or to the receiving environment.

#### 9.4.7 Decommissioning

Consider the following when decommissioning decanting earth bunds:

- Do not remove decanting earth bund until the catchment area has been appropriately stabilised.
- Refer to section 9.6 for dewatering.

- Remove and dispose of accumulated sediment to an appropriate location.
- Remove pipes, fabric and other construction materials.
- Backfill, re-grade and stabilise the disturbed area.

## 9.5 Flocculation

### 9.5.1 Definition and purpose

Flocculation is a method of enhancing the settlement of suspended sediment from earthworks runoff and is typically used in conjunction with sediment retention ponds or decanting earth bunds.

The flocculant neutralises the electrical charge that cause individual sediment particles to repel each other. The sediment particles clump together with the flocculant, and these larger particles then settle out.

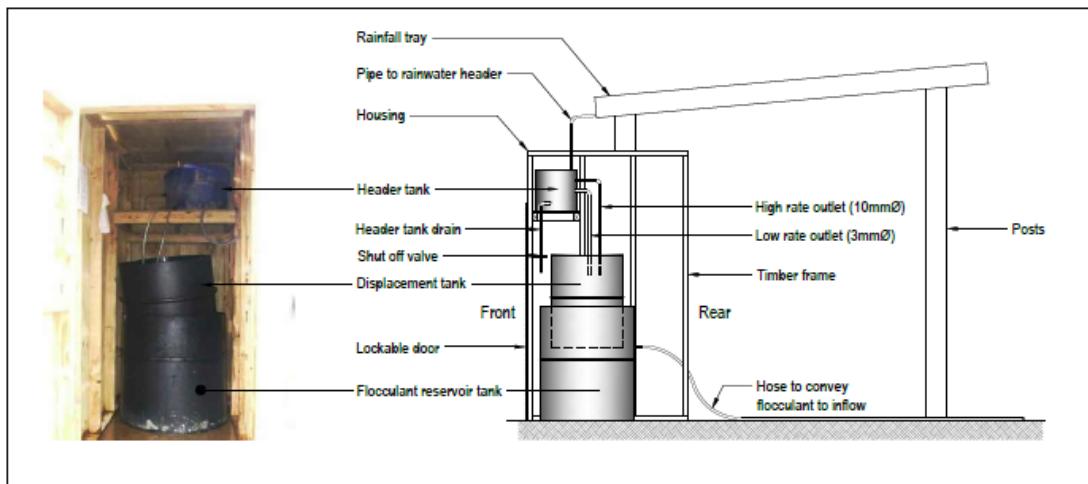

Figure 9-20 Rain Activated Flocculant Dosing System (Auckland Council)

The purpose of flocculation is:

- To treat sediment laden runoff to an extent greater than standard sediment control practices; and
- To reduce the volume of sediment leaving a site, protecting sensitive downstream environments from excessive sedimentation and water quality degradation.

In a number of environments and soil types, flocculation is the only method that will remove fine suspended (colloidal) material from runoff.

### 9.5.2 Conditions where the practice applies

Flocculation is used to enhance the retention of sediment on earthworks sites:

- Where there are potential adverse effects on sensitive receiving environments resulting from sediment discharge (flocculation also needs to be carefully managed to ensure acidic discharges of excess flocculant do not occur).
- Where clay and/or silt soils (particle size < 0.005mm) are present. In Tasman district, land disturbance within Moutere Gravels, or other soils with significant clay components, flocculation will be needed to achieve effective sediment retention.
- Where site constraints prevent sediment retention ponds being designed or constructed to the required shape or volume specifications.
- Where sediment retention ponds are not performing adequately.
- In areas with highly erodible soils or very steep or long slopes, which may have high sediment yields during runoff events.
- On earthworks sites with repeated machinery movements (for example on haul roads) which can result in high sediment loadings in stormwater.

### 9.5.3 Limitations

Flocculation has the following limitations:

- Dependent on the flocculant used, flocculation generally works on clay and silt soils (particle size < 0.005mm) but is less effective on other soil types.
- Flocculation requires specialist expertise and a high degree of monitoring and maintenance.
- Liquid flocculant dosing systems need regular monitoring to ensure they do not run out of chemical during rainfall events and that pH levels remain within acceptable ranges (ie pH6.5-8.0 ). Dosing should cease if the pH drops below 5.5 or rises above 8.5.
- Spills of flocculant can have adverse effects on the receiving environment and careful onsite management and appropriate staff training is required.
- Resource consent or authorisation as a condition of consent is required for the use of flocculants

### 9.5.4 Key design criteria

#### 9.5.4.1 Desired Outcomes

Flocculation systems should be designed and managed to achieve the following outcomes:

- Consistently high removal of suspended sediments from runoff for events up to the design event for the sediment retention pond or decanting earth bund.
- No overdosing of ponds and no release of excess flocculant or low pH water (less than 5.5 pH units) to receiving environments.
- Dosing only once flow into the pond has commenced.
- Sufficient flocculation capacity to treat events up to the design storm volume (whether this is achieved through system capacity or an appropriate maintenance regime – eg topping up systems before and during events).
- No spills of flocculant.

Flocculation is a specialist activity requiring management by suitably qualified personnel. Only experienced contractors should be used.

#### 9.5.4.2 Flocculant Type

There are a variety of flocculants available on the market, and many are available in both a solid and liquid form.

Solid flocculants are used as blocks or pellets and may come in socks or bags that are placed directly in areas of concentrated flows upstream of settlement areas.

Liquid flocculants are used in conjunction with sediment ponds and a dosing system is used to ensure the appropriate amount of flocculant is released to match the volume of runoff to be treated.

The flocculant type typically used is liquid Polyaluminium Chloride (PAC). Alternative flocculants will require specific approval from the Council prior to use.



Tests using soils from the site, or from a site that has similar soil characteristics, will be needed to determine the most appropriate flocculant type and the optimal dosing rate required (ie to determine the volume of runoff from your site that 1 litre of your selected flocculant will treat).

In all cases flocculants are to be used to the manufacturer's specifications. Different flocculants can contain different levels of active ingredient and it is vital that the design of the liquid dosing system or installation method for solid flocculants reflects the particular flocculant to be used. Changes to the flocculant type or brand may require review and amendment to the dosing system or installation method.

#### 9.5.4.3 Flocculation Plan

If using flocculation, a Flocculation Plan should be provided to Council which includes the following as a minimum:

- Name, contact details and qualification/experience of flocculation provider.
- Flocculant type to be used including:
  - Active ingredients and their concentrations
  - Dosing rate applicable to the site soils (including lab results)
- Methodology for distribution or dosing of flocculant, including an outline of any changing flocculation needs as works progress and disturbed areas are stabilised.
- Design details of any liquid flocculant dosing system, including tank and hose sizes and dosing point location.
- Monitoring and maintenance plan (which reflects local rainfall characteristics).
- Contingency planning in the event of a flocculant spill.
- Relevant resource consent details.

Further information on dosing system design and flocculation is available in Auckland Council's Technical Publication 227 "*The Use of Flocculants and Coagulants to Aid the Settlement of Suspended Sediment in Earthworks Runoff : Trials, Methodology and Design [draft]*" June 2004.

#### 9.5.4.4 Monitoring and adjusting for changing site conditions

Each new flocculant treatment system needs to be monitored carefully during the first few rainfall events to check that the system is effective, and to ensure that under or overdosing is not occurring.

If overdosing is suspected because the pond dead storage water is exceptionally clear, samples should be taken from the pond for pH testing. The dosing regime should be adjusted depending on the outcome of these results.

The dosing system may require modification if earthworks alter the extent of the contributing catchment or the quality of stormwater runoff is improving because of stabilisation of the site. Failure to do so will cause either under or overdosing of flows entering the sediment retention pond.

#### 9.5.4.5 Flocculant spill management

- There should be earth bunds around the flocculation and refilling station to contain any spills of flocculant. If there is a spill of flocculant onto the ground it should be immediately contained to prevent it entering water. The spilt flocculant should be recovered if possible and placed in polyethylene

containers. If the spilt flocculant cannot be recovered, it should be mixed with a sufficient volume of soil to neutralise the flocculant (eg at least ten times the volume of spilt flocculant). The soil with which the flocculant has been mixed should be buried a minimum of 0.5 metres below the surface.

- If there is a spill of flocculant into ponded water, discharge from the pond to natural water (streams, rivers, lakes, wetlands, etc) should be prevented.
- If there is a spill of flocculant into flowing water:
  - The Tasman District Council should be advised immediately
  - Any further discharge of flocculant into the water should be prevented
  - The volume of the spill should be recorded
  - If possible, the water and spilt flocculant should be pumped into a bund or pond until all the spilt flocculant has been removed from the watercourse
  - Any downstream users should be identified and advised as soon as possible, especially if the flocculant cannot be removed from the watercourse.

### **9.5.5 Decommissioning**

When decommissioning flocculation systems remove all components of the flocculation shed. Equipment can be stored for future use on another pond.

Pond sediments will include flocculant bound in the settled sediments. These need to be disposed of to an appropriate location (refer section 9.1.7).

## 9.6 Dewatering

### 9.6.1 Definition and purpose

Dewatering is the removal of water from excavations and trenches. Dewatering is generally done by pumping and the resulting water should be discharged through a sediment retention device, such as a sediment sump (refer 9.5.5), dewatering sock, bag or similar device (eg modified skip bin, Figure 9-21).

Under no circumstances is sediment laden water to be discharged directly to roads, stormwater, waterways or areas that may flow into receiving environments, without adequate treatment to retain sediments.

In some situations sediment laden water may be dewatered to a soakage pit provided there are no other contaminants in the water, the pit has sufficient drainage capacity and it is not located near a waterbody or bore or where there is a risk of channel migration or erosion.

### 9.6.2 Conditions where practice applies

Dewatering devices are used to dewater trenches and excavations during construction.

### 9.6.3 Limitations

- Pumping can resuspend sediment requiring an additional chamber for settling.
- Sufficient time for adequate settling may be difficult to achieve.

Always try to minimise the volume of water that requires dewatering, such as limiting length of open trench or providing diversions above excavations.

### 9.6.4 Key design criteria

To dewater, consider the following options:

- Minimising the volume of water and the levels of sediment.
- Retaining sediment laden water on site and maximising the settling of sediment on site (settling may be aided by the addition of flocculant, refer section 9.5).
- Always dewater the cleaner water at the top first.
- Residual sediment laden water can be pumped to a tank or truck and used as a dust suppressant.
- Smaller volumes of sediment laden water can be pumped to specially designed settling tanks (eg modified skip bins) or dewatering bags/socks. These are particularly useful on small sites such as for house construction where land area is limited.
- If utilising dewatering bags or socks give consideration to their removal when full as they may weigh a considerable amount.



Figure 9-21 Modified Skip Bin for Dewatering

- Small volumes of sediment laden water can also be pumped to a decanting earth bund, however care needs to be taken to ensure that these devices are not overwhelmed and that fine sediments are adequately trapped.
- Larger volumes can be pumped to a sediment retention pond. Always pump to the forebay.

### 9.6.5 Maintenance and Decommissioning

Regularly check dewatering tanks, socks and bags for remaining capacity and for damage (rips, tears, leaking joints, etc) and repair/ replace or empty as necessary to ensure ongoing sediment retention.

Dispose of collected sediment and used socks or bags to an appropriate location to ensure that sediment does not discharge to the receiving environment.

## 9.7 Sediment Sump

### 9.7.1 Definition and Purpose

Sediment sumps are temporary pits which trap and filter sediment-laden water from areas of excavation, or areas where water cannot drain by other means, before it is pumped to a suitable discharge area.

### 9.7.2 Conditions where practice applies

When water collects during the excavation phase of construction.

- Particularly useful in urban areas during excavation for building foundations.
- May also be used to dewater sediment retention measures.

### 9.7.3 Limitations

Always try to minimise the volume of water that requires drainage through the sediment sump for example providing clean water diversions up slope around excavations.

### 9.7.4 Key Design and Construction Criteria

The design is based on a perforated vertical standpipe placed in the centre of a pit which is then backfilled with aggregate.

- Determine the number of sediment sumps and their locations on site in accordance with the required dewatering facilities.
- Sediment sump dimensions are variable, but require a minimum depth of 1m and a minimum volume of 2m<sup>3</sup>.
- Construct the standpipe from 300 – 600mm diameter pipe with a grid of 10 mm diameter perforations at 60mm spacings along the standpipe. For a 1m deep sump the standpipe will need to be 1m long.



Figure 9-22 Dewatering Pipe Sock and Bag

- If the water is to be pumped directly to a receiving environment, then wrap geotextile fabric around the standpipe to help achieve a clean water discharge. When geotextile fabric is used, the surface area of the standpipe will need to be increased and the pumping rate decreased to prevent the geotextile becoming rapidly blocked.
- Place a base of 50mm sized aggregate in the sediment sump to a depth of 300mm.
- Place the standpipe in position so that it extends 300mm above the outer edge of the sediment sump.
- Backfill the sump area with 50mm sized aggregate so that the aggregate level at the standpipe extends 100 mm above the anticipated standing water elevation (refer Figure 9-23).
- Pump water from the centre of the standpipe to a suitable discharge area.
- Direct the discharge to an appropriate outlet.

#### **9.7.5 Maintenance**

Undertake ongoing checks throughout the use of the Sediment Sump to ensure effective operation. Regularly check sumps for remaining capacity and repair/ replace as necessary to ensure ongoing sediment retention.

Dispose of collected sediment to an appropriate location to ensure that sediment does not discharge to the receiving environment.

#### **9.7.6 Decommissioning**

In decommissioning sediment sumps consider the following:

- Install a silt fence or other device below the sump prior to decommissioning.
- Dewater sump.
- Remove and correctly dispose of all accumulated sediment and aggregate.
- Remove sump construction materials.
- Backfill the sump and compact soil, re-grade as required.
- Stabilise all exposed surfaces.



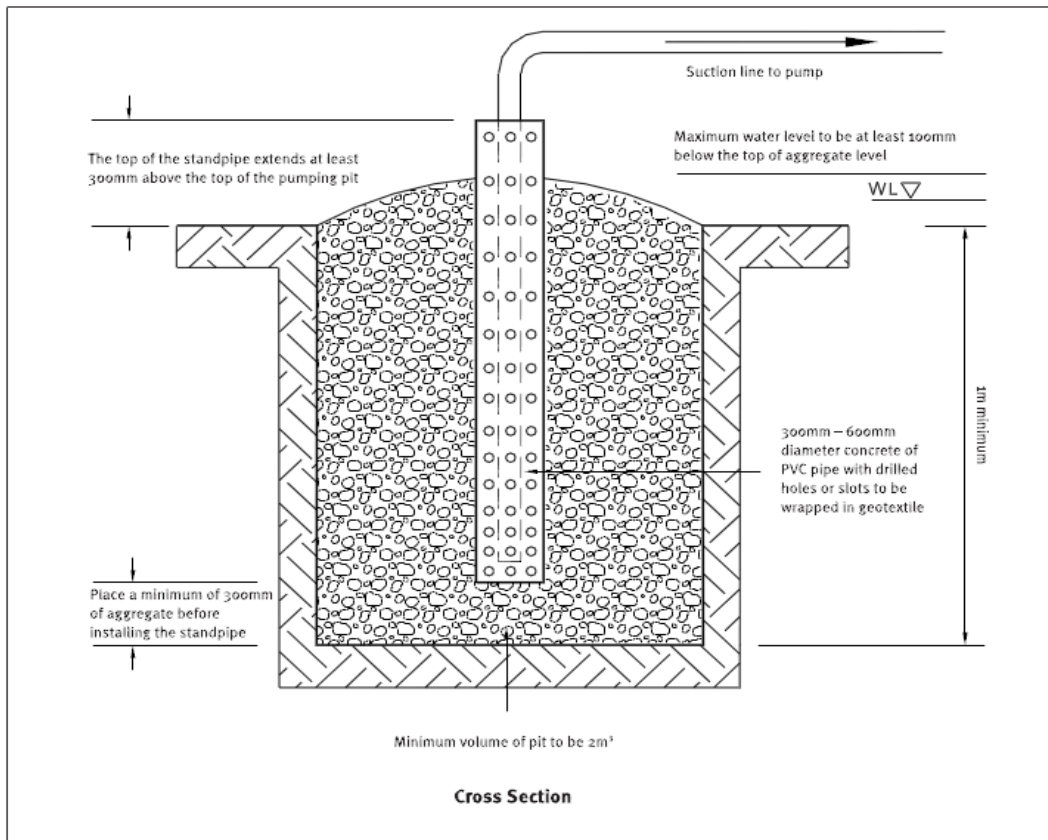

Figure 9-23 Sediment Sump (source ARC TP90 1999)

## 9.8 Stormwater inlet protection

### 9.8.1 Definition and purpose

Stormwater inlet protection is a barrier across or around a stormwater inlet (cesspit/sump). It is used to intercept and filter runoff carrying sediment or other contaminants before it enters a reticulated stormwater system, thereby preventing sediment-laden flows affecting infrastructure or entering receiving environments. The protection may take various forms depending upon the type of inlet to be protected and the potential for non-sediment contaminants (refer Chapter 10) to be present in runoff.

Stormwater inlet protection is a secondary sediment control device and should not be used as a standalone primary device. It should only be used in conjunction with other erosion and sediment control measures.

Stormwater inlet protection can also help delineate the location of stormwater inlets, allowing contractors to avoid vehicle movements, storage of materials and undertaking high risk activities (eg refuelling) in or near these areas.



Figure 9-24 Stormwater Inlet Protection – silt fence and geotextile sock

### 9.8.2 Conditions where practice applies

Stormwater inlet protection is suitable for small, low-gradient catchments (< 0.25ha, with slopes < 5%) as a component of a broader erosion and sediment control system.

Use stormwater inlet sediment control devices as an integral component of a much broader and more comprehensive erosion and sediment control system.

### 9.8.3 Limitations

Stormwater inlet protection has the following limitations:

- Only to be used in very small catchments (< 0.25ha).
- Not to be used as a standalone treatment device. They have relatively low sediment removal efficiency and should be used a part of a treatment train approach.
- High maintenance requirements, as there is a potential for reduced hydraulic efficiency and blockage - and therefore increased risk of bypass to downstream inlets, other control devices or inundation of downstream areas.
- Easily damaged by vehicles and construction equipment.
- If the inlets become fully blocked, they can lead to downstream flooding. Ensure flooding does not occur.
- Hay bales are not considered appropriate as storm water inlet protection.

#### 9.8.4 Key design and construction criteria

Design and construction specifications will vary according to the type of inlet protection, however, consider the following general principles:

- Maximum catchment area of 0.25 hectares to each inlet; stormwater inlet treatments should be limited to areas with a general slope of less than five percent, and the area immediately around the inlet should be less than one percent.
- Ensure the stormwater system retains adequate capacity. Inlet protection should not divert water over cut or fill, down slopes, or away from the stormwater inlet.
- Potential overflow scour needs to be considered during high intensity events or if geotextile fabric clogs. Always ensure a stable emergency bypass is included on all devices. Plan for where the bypass system will divert water to.
- Stormwater inlet protection around inlets at low points should be set back to allow the drain to function normally during periods of heavy rain.
- Ensure the location or operation of the device will not cause a public safety issue.
- An earthen bund placed immediately downslope of the device may hold ponded water around the inlet and prevent it from bypassing the drain.
- Keep stockpiles and loose sediment away from all drains and stormwater inlets.

The following sections outline several methods for inlet protection including:

- Silt fence.
- Filter fabric and aggregate.
- Sandbag check dams.
- Proprietary (off-the-shelf) products.

##### 9.8.4.1 Silt fence

A silt fence can be erected around the inlet (see section 9.2 for general silt fence design). This method is appropriate where cesspits have been connected to a stormwater system and are collecting runoff from disturbed soil surfaces.

Support Silt fences well to avoid collapse and kept to less than 300mm in height so that runoff does not cause local flooding and/or is not directed into adjacent catchments.

##### 9.8.4.2 Filter fabric and aggregate

All points where runoff can enter the cesspit should be protected with suitable geotextile fabric. Back entry sumps require additional fabric protection secured in place.

Lay coarse geotextile fabric over the cesspit and up onto the kerb with a layer of aggregate material to act as a primary filter and to hold the fabric in place.



Figure 9-25 Inlet protection with aggregate on top of geotextile fabric

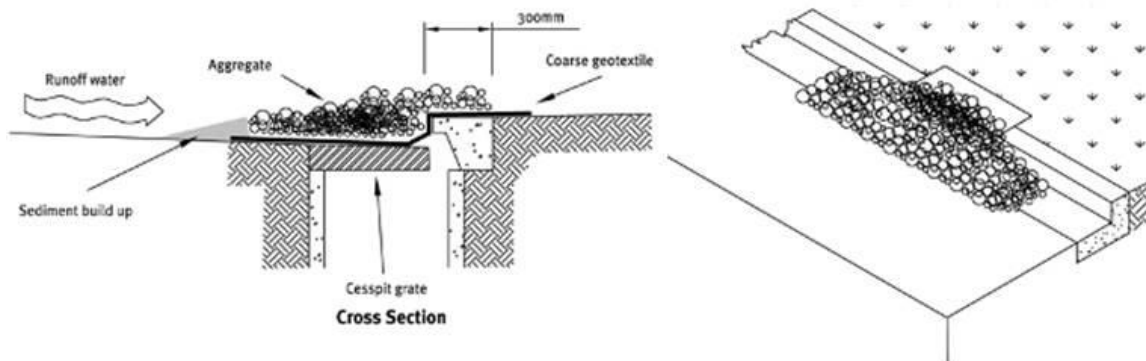

Figure 9-26 Stormwater Inlet Protection Filter Media Design

#### 9.8.4.3 Sandbag Check dams

Place a series of low sandbag check dams up the gutter from cesspits to act as a series of sediment traps. The check dams require a spillway lower than the kerb to ensure that runoff does not encroach onto the berm area and cause scouring or flooding of adjacent properties.

Construct check dams out of up to six sandbags laid end to end, with no gaps, in an arc away from the kerb and up the road to create a series of impoundment areas.

Sediment that settles out behind the check dam on the road surface should be removed and disposed of to an appropriate location where it will not enter water.



Figure 9-27 Sandbag check dam in gutter

#### 9.8.4.4 Proprietary (off-the-shelf) products

A number of 'off-the-shelf' products are available in New Zealand for example filter socks and catchpit inserts. The manufacturers' specifications should be followed in using these products.

These products can be used where road or parking surfaces are established, and some form of storm water inlet protection is required. They typically allow for high flow bypass and can also be relatively easily lifted from the storm water inlet and cleaned as required before reinstalling.

Additional support should be provided for filter socks and bags, so they are not pushed into the inlet by the force of the water.

### 9.8.5 Maintenance

Maintenance will vary according to the type of inlet protection however consider the following when maintaining stormwater inlet protection measures:

- Inspect daily and during and after rainfall events.
- Beware of blockages and leaks which may affect performance.
- Check to see if flows have been diverted away from the device and what if any damage has been caused.
- Clean all accumulated sediments immediately.

- Repair and modify any problems immediately.

#### **9.8.6 Decommissioning**

Decommissioning will vary according to the type of inlet protection however consider the following when decommissioning stormwater inlet protection measures:

- Ensure all areas within the contributing catchment are suitably stabilised before removal of inlet protection.
- Remove and dispose of accumulated sediments to an appropriate location.
- Remove the inlet protection, reuse and recycle components wherever possible.
- Stabilise any disturbed areas around the stormwater inlet.



/

# Chapter 10

## Non-Sediment Contaminants

NELSON TASMAN  
**EROSION AND SEDIMENT  
CONTROL GUIDELINES**

JULY 2019





## TABLE OF CONTENTS

<b>10</b>	<b>NON-SEDIMENT CONTAMINANTS</b> .....	<b>1</b>
10.1	Non-Sediment Contaminant Effects .....	1
10.2	Materials storage .....	1
10.3	Materials Use and Onsite Activities .....	2
10.4	Disposal .....	2
10.5	Contingency Planning .....	2

### LIST OF TABLES

Table 10-1	Common Potential Non-Sediment Contaminants and their Sources .....	4
------------	--	---

### LIST OF FIGURES

Figure 10-1	Site fuel tank with bunding to contain fuel in the event of a spill .....	2
Figure 10-2	Good example of a port-a-loo placed in a location with consideration also given to erosion and sediment controls .....	3

## 10 NON-SEDIMENT CONTAMINANTS

Non-sediment contaminants consist of chemicals and materials used on site that directly or indirectly discharge into receiving environments (including adjacent land) from site activities. Some land disturbing activities, such as construction activities can generate a variety of non-sediment contaminants, many of which are listed in Table 10-1.

### 10.1 Non-Sediment Contaminant Effects

As discussed in Chapter 3 non-sediment contaminants can have both acute effects (eg sudden severe exposure, potentially causing serious injury or death) or chronic effects (prolonged or repeated exposure causing longer term health and fertility problems), as well as impacting on ecosystems, creating imbalances that lead to a change in species composition, for example algal blooms.

Non-sediment contaminants can have the following effects:

- offensive odours.
- impacts on people's health.
- discolouration of water.
- reduced oxygen levels in water causing death of aquatic wildlife.
- excessive algal growth and blooms.
- death or injury of aquatic wildlife - the occurrence of dead or distressed fish and eels can be an indicator of severe contamination and should be addressed immediately.
- cause cancer or mutations in animals and humans leading to death or reproduction issues.
- bioaccumulation affecting organisms feeding on contaminated food sources.

There are some basic steps that can be taken to reduce the risk of spills and discharge of non-sediment contaminants –even on small sites, including consideration of materials used, their storage, disposal and contingency planning in the event of spills (refer Table 10-1).

### 10.2 Materials storage

When storing materials, the following steps should be taken to minimise risk:

- Store hazardous materials in a designated area with appropriate signage.
- Always consider storing materials in a covered area.
- Follow manufacturers' instructions for storage of materials.
- Hazardous material storage on site should be minimised.
- Materials should be stored in secondary containments, such as a bunded area made of impervious materials and drained to an appropriate area when rainwater ponds within the bund.
- Fuel tanks should be bunded to store 110% of the fuel tank capacity.
- Temporary storage areas should be located away from vehicular traffic, near the construction entrance and away from waterways or storm drains.
- New Zealand Material Safety Data Sheets should be supplied for all materials stored on site. Chemicals should be kept in their original labelled containers.

- Store chemicals, drums or bagged materials on a pallet to keep them off the ground and where possible, in secondary containment.
- If drums are kept uncovered, store them at a slight angle to reduce ponding of rainwater on the lids to reduce corrosion.
- Prepare an emergency response plan in case of a spill or accident.

### 10.3 Materials Use and Onsite Activities

- Whenever possible, undertake site activities that could result in non-sediment contaminants in a designated area within sediment controls. These should be identified as Trade Activity Zones (TAZ) on the Erosion and Sediment Control Plan.
- Follow manufacturers' instructions for use of materials.
- Use chemicals and materials carefully and clean up any spilled product. Do not hose the material into a reticulated stormwater system or waterway.
- Hazardous materials should be handled as infrequently as possible.
- Keep tools and machinery well maintained to avoid leaks.
- Refuelling and maintenance should only be undertaken in designated areas with sufficient stormwater protection.



Figure 10-1 Site fuel tank with bunding to contain fuel in the event of a spill

### 10.4 Disposal

- Properly dispose of, or recycle, unused portions or containers once they are empty.
- Only clean equipment, machinery and tools in areas that drain to sewer.
- Clean up and appropriately dispose of treated wood sawdust and wood off-cuts.
- Make it easy for staff to appropriately dispose of wastes by placing waste and recycling facilities at appropriate locations.

### 10.5 Contingency Planning

- Assess what materials and wastes will be expected on site to allow for planning of: waste minimization; provision of appropriate wash down, recycling or waste disposal facilities; provision of appropriate spill kits; and determining staff training requirements.
- Identify and protect sanitary sewer lines that may exist on the site to avoid damaging them.
- The site should have spill clean-up kits appropriate to the materials used on site with relevant training of staff.
- Ensure all subcontractors and staff are aware of their responsibilities.



Further information on managing hazardous substances is available from the EPA website ([www.epa.govt.nz](http://www.epa.govt.nz)).



Figure 10-2 Good example of a port-a-loo placed in a location with consideration also given to erosion and sediment controls

Table 10-1 Common Potential Non-Sediment Contaminants and their Sources

Work activity/product	Contaminant sources	Contaminant indicator	Specific contaminants	Mitigation approach
Adhesives and paint	Adhesives, glues, resins, epoxy, PVC cement Caulks, sealers, putty, sealing agents Coal tars (naphtha, pitch) Household and commercial paint	Oily sheen or other discolouration from some product	Phenolics, formaldehydes, asbestos, benzene, ethyl benzene, toluene, xylene, phenols, and naphthalene	Store materials in a location that is not subject to rainfall contact Use adhesives carefully and clean up any spilled material Properly dispose of containers once they are empty Only clean brushes/applicators in areas that drain to sewer
Asphalt paving	Hot and cold mix asphalt where special coatings are used	Depends on coatings used	Depends on coatings used	New coated paving should not discharge directly to a reticulated system or to a receiving environment Drainage from coated asphalt should go to a stormwater treatment system designed to capture contaminants of concern.
Cleaners	Cleaners, ammonia, lye, caustic sodas, bleaching agents and chromate salts	Discolouration, odour	acidity/alkalinity	Store materials in a location that is not subject to rainfall contact Use cleaners carefully and clean up any spilled product. Do not hose the material into a reticulated stormwater system Properly dispose of containers once they are empty Only clean brushes/applicators in areas that drain to sewer
Concreting	Cement	Discolouration	Alkalinity (high pH)	Concrete truck chutes, pumps and internals should be washed out only where it will not drain to stormwater or waterways. Unused concrete remaining in truck and pump should be returned to the originating batch plant or can be pumped out to an appropriate location, left to set then broken up and disposed to clean

Work activity/product	Contaminant sources	Contaminant indicator	Specific contaminants	Mitigation approach
				<p>Hand tools should be washed off only into formed areas awaiting installation of concrete or asphalt where it will not drain to stormwater or waterways</p> <p>Equipment that cannot be easily moved, such as concrete pavers, should only be washed in areas that do not drain directly to receiving environments</p>
Flocculation	Sediment Pond Flocculants	Overly clear water in sediment pond, green pond water (low pH)	Poly Aluminium Chloride (PAC)	<p>Maintain good flocculation management procedures (refer section <b>Error! Reference source not found.</b>)</p> <p>If pH drops below 6.5, take the pond offline and stabilise the pond pH with lime (calcium hydroxide) before reconnecting the decant system.</p>
Nutrients	Disturbed site soils Cut vegetation (grass/weed clippings, tree prunnings/clearance) Fertilisers	Excessive growth of filamentous green algae. Little discolouration	Nitrogen Phosphorus Magnesium Sulphur	<p>Limit soil disturbance were possible and implement effective erosion and sediment control practices to reduce nutrient export from the site</p> <p>Ensure cut/cleared vegetation is disposed of where it will not enter stormwater or waterways</p> <p>Ensure fertilizer application when stabilizing sites is done to the recommended concentration and using appropriate methods to ensure excess fertilizer runoff does not occur into stormwater or waterways</p>
Sanitary waste	Portable toilets Sewer overflows Sewer / septage pipe disturbance	Visible sanitary waste, odour	Faecal bacteria and, viruses including pathogens, BOD, portable toilet chemicals (eg. Glutaraldehyde)	<p>Secure and protect portable toilets to avoid knocking them over</p> <p>Have portable toilets serviced as needed</p> <p>Identify and protect sanitary sewer lines that may exist on the site to avoid damaging them</p>

Work activity/product	Contaminant sources	Contaminant indicator	Specific contaminants	Mitigation approach
Treated wood	Leachate from stored treated timber Sawdust and wood off-cuts Formwork	Greenish tinge to water, sawdust and cut wood pieces	Copper Chromium Arsenic	Keep treated timber covered to keep it dry and minimise leaching of contaminants. Where possible also store on an impervious surface, not draining to stormwater (eg the plastic covering used during delivery)  Where possible, minimise the use of treated timber for temporary forming  Clean up and appropriately dispose of treated wood sawdust and wood off-cuts
Vehicle and equipment operation, use and maintenance	Oil, lubricants, diesel, petrol, degreasers, coolants, hydraulic fluid, refrigerants	Oil sheen, sediment, black residue	Total petroleum hydrocarbons, polyethylene glycol (a coolant used in radiators) benzene and derivatives, ammonia	Fuel tanks should be banded to store 110% of the fuel tank capacity  Refuelling and maintenance should only be undertaken in designated areas with sufficient stormwater protection  Keep machinery well maintained to minimize leaks  Procedures and practices should be implemented to avoid the discharge of lubricants or coolants to storm drains or receiving systems  Have spill prevention and control measures and training in place

# Chapter 11

## Activities Within and Around Watercourses

NELSON TASMAN  
**EROSION AND SEDIMENT  
CONTROL GUIDELINES**

JULY 2019









## TABLE OF CONTENTS

<b>11</b>	<b>NON-SEDIMENT CONTAMINANTS</b> .....	<b>1</b>
11.1	Introduction .....	1
11.2	What constitutes a watercourse?.....	3
11.3	Where is the bed of a river?.....	4
11.4	Types of Activities and Methods of Protection.....	4
11.5	Eel and fish recovery .....	5
11.5.1	Eel and fish recovery for watercourse diversions .....	5
11.5.2	Eel and fish recovery and mitigation for works in wetted channels.....	6
11.6	Temporary watercourse crossings .....	7
11.6.1	Definition and purpose.....	7
11.6.2	Conditions where practice applies.....	7
11.6.3	Key design criteria .....	7
11.6.4	Maintenance of temporary crossings .....	11
11.6.5	Decommissioning of temporary crossings.....	11
11.7	Diversion by coffer dam .....	12
11.7.1	Definition and purpose.....	12
11.7.2	Conditions where practice applies.....	12
11.7.3	Limitations.....	12
11.7.4	Key design and construction criteria .....	12
11.7.5	Maintenance .....	13
11.7.6	Decommissioning .....	13
11.8	Diversion by damming and piping .....	14
11.8.1	Definition and purpose.....	14
11.8.2	Conditions where practice applies.....	14
11.8.3	Limitations.....	14
11.8.4	Key design and construction criteria .....	15
11.8.5	Maintenance .....	16
11.8.6	Decommissioning .....	16
11.9	Diversion by temporary channel .....	17
11.9.1	Definition and purpose.....	17
11.9.2	Conditions where practice applies.....	17
11.9.3	Key design criteria .....	17
11.9.4	Maintenance .....	19
11.9.5	Decommissioning .....	19

## LIST OF FIGURES

Figure 11-1	Bridge construction with a temporary stream diversion using pipe (yellow) and pump (not shown). The pump shown is dewatering the works area to an offline sediment retention pond) .....	2
Figure 11-2	Fish recovery in Reservoir Creek using electric fishing technique and a recovered eel awaiting transfer .....	6

Figure 11-3	Temporary culvert crossing .....	7
Figure 11-4	Temporary Bridge Crossing .....	8
Figure 11-5	Temporary bridge example for small streams (with anchor to retain bridge components during floods).....	8
Figure 11-6	Temporary culvert crossing with the rock protection at the outfall to reduce stream erosion	9
Figure 11-7	Culvert with Energy Dissipation Baffles .....	9
Figure 11-8	Temporary culvert crossings with box culvert and multiple culverts .....	10
Figure 11-9	Temporary ford with truck and wheel washes.....	10
Figure 11-10	Aquadam used on the Ruby Bay bypass to isolate an estuary work site .....	12
Figure 11-11	Temporary Culvert Crossing .....	14
Figure 11-12	Reservoir Creek diversion with intake pipe (upper right) and outlet with energy dissipation (lower right).....	14
Figure 11-13	Pipe diversion during Ruby Bay Bypass (D.Shaw) .....	15
Figure 11-14	Pipe diversion during Ruby Bay Bypass (D.Shaw) .....	15
Figure 11-15	Use of Marine Ply flume as a Stream Diversion.....	17
Figure 11-16	Diversion channel prior to upstream plug removal with fish stop nets (red) .....	17
Figure 11-17	Opening up bypass channel and damming off existing one .....	18
Figure 11-18	Temporary Watercourse.....	18
Figure 11-19	Downstream damming of original watercourse to isolate works area .....	18
Figure 11-20	Temporary diversion and culvert while a new permanent culvert is constructed.....	19
Figure 11-21	Re-establishment of flow in original channel.....	19

## 11 NON-SEDIMENT CONTAMINANTS

### 11.1 Introduction

Works within or around watercourses have very high potential for erosion and discharge of sediment as they are undertaken in or near flowing water - the major cause of erosion. Flowing water causes ongoing scour and provides the transport mechanism to allow sediment to be dispersed downstream and into other receiving environments.

The potential effects of activities within and around watercourses fall into two categories:

1. Direct effects on the immediate area of works, including the bed, banks and vegetation.
2. Effects on downstream areas from sediments and debris generated by the works degrading water quality, causing habitat change or affecting flood risks.

Works in or around watercourses can have a direct impact on watercourse habitat and ecology, through:

- Direct removal and destruction of substrate habitat by digging out the bed.
- Removing areas used for wildlife spawning or rearing, both in-stream and along the banks.
- Removing cover (eg vegetation, woody material, substrate) used by wildlife for avoiding predation or waiting in prey.
- Removing vegetation that provides food into the stream (eg leaf and insect fall).
- Removing vegetation that provides shading and reduces water temperatures.

Effects on water quality can have far reaching impacts, particularly where fine sediments are generated that may be transported long distances downstream. Unlike contaminants such as nutrients, the ecological response to fine sediment discharges is almost always adverse right from small concentrations (Quinn 2000). Sedimentation during a storm can have significant adverse effects, however sedimentation generated during low flow conditions can have devastating impacts to aquatic resources. Effects of sediment include:

- Destroying aquatic habitats by filling in pool areas and reducing habitat diversity.
- Reducing flow carrying capacity, potentially increasing flooding risks, due to deposition in the stream bottom.
- Smothering of wildlife living in the riverbed.
- Reducing light available for aquatic plants and making it harder for wildlife to see for feeding.
- Damage to aquatic food supplies through loss of biofilms on stream beds and the filling of streambed features, such as crevices, where organic matter would normally collect.
- Damage to the fine gills and mouth parts of macroinvertebrates and fish due to the abrasive suspended sediment and stressing of animals affecting growth and mortality rates.
- Impacts on the reproduction of fish species by inhibiting colonization and migration and the destruction of developing eggs and newly hatched fry.

There are also other effects, such as those on amenity and modification of natural character.



Great care is required for works in and around watercourses to avoid potential effects as much as possible. Where this is unavoidable, specific control measures and methodology are required to minimise potential adverse impacts.

Activities in watercourses mean those within the water or the river bed (refer section 11.3 while works around watercourses mean those in close proximity (eg within 15m) and in particular, works on areas sloping into watercourses. There is also a general requirement for all areas to comply with Part 6 of the TRMP and the NRMP regarding discharges to land, air and water.

All activities in a watercourse, including the placement of structures and diversion of water will need to comply with Parts 4, 5 and 6 of the TRMP and relevant sections of the NRMP may require resource consent.

Depending on the site characteristics and specific activities (eg other structures), there may also be other relevant rules in the TRMP and the NRMP, for example those relating to stormwater or heritage aspects. It is recommended that Council planners are contacted to discuss each site on a case by case basis to ensure all the relevant consents are sought.

Key aspects considered in the TRMP and the NRMP for activities in and around watercourses include:

- Potential for causing erosion or flooding.
- Potential for obstruction of flood water or navigation.
- Impacts on fish passage and spawning.
- Impacts on habitats and bird nesting.
- Impacts on vegetation or soil, bank stability and water quality.
- Structures in Water Conservation Order areas (eg in the Buller and Motueka catchments – refer Chapter 3, section 3.4.9).
- Diversions in wetlands.
- Impacts on cultural heritage sites and public access.
- Impacts on visual clarity and colour of receiving waters and depth of sediment depositions.
- Removal of all structures and materials and reinstatement of natural bed at decommissioning.



Figure 11-1 Bridge construction with a temporary stream diversion using pipe (yellow) and pump (not shown). The pump shown is dewatering the works area to an offline sediment retention pond)

## 11.2 What constitutes a watercourse?

From a planning and resource consent perspective a watercourse is anything defined as a river under the Resource Management Act (RMA).

The RMA defines River as:

*“River means a continually or intermittently flowing body of fresh water; and includes a stream and modified watercourse; but does not include any artificial watercourse (including an irrigation canal, water supply race, canal for the supply of water for electricity power generation, and farm drainage canal.”*

Any activities within or around watercourses that meet the definition of river will need to comply with parts 4, 5 and 6 of the TRMP and the NRMP regarding activities in beds, water takes, diversions and discharges. Further information on Tasman’s perennial and intermittent rivers and streams can be found in Chapter 5.4.

### A drain or a stream?

Many streams in Tasman and Nelson, particularly in lowland areas have been highly modified, including channel straightening, channel lining and armouring and changes to riparian vegetation. Many are also referred to as ‘drains’, but these are still legally classed as rivers (refer Case Law 2003 and 2009). This is also the case for diversions of previous water bodies – including streams, rivers and wetlands – effectively if there was a water body there previously, then any subsequent channel formed to divert the water (even if completely man-made) is still considered a river under the RMA (Case Law 2002, Case Law 2009). This makes a distinction between an artificial channel and an artificial watercourse - the former is still a river; the latter is not.

If there is any doubt about the nature of a watercourse on site, it is prudent to consider it as a natural watercourse (river), even when highly modified. If you are unsure about a watercourse or identifying where the bed of the river is for consenting purposes, seek advice from Council.

The TRMP further defines artificial watercourses as:

*“Artificial Watercourse means a constructed watercourse that contains no natural portion from its confluence with a river or stream to its headwaters and includes any:*

- (a) irrigation canal;
- (b) water supply race;
- (c) canal for the supply of water for electricity power generation;
- (d) roadside drain (or water table or culvert) that is constructed alongside or under roads used by vehicles and has as its primary function the drainage of surface water from the road;
- (e) farm drainage canal.”

Artificial watercourses still contain water and are subject to rules in Parts 5 and 6 of the TRMP regarding water takes, diversions and discharges. In considering erosion and sediment control it is important to remember that most artificial watercourses flow into other receiving environments (rivers, lakes and wetlands, etc) or water is taken for specific end uses, and it is therefore important to minimise the generation of sediment and its transport into downstream areas.

In addition, some artificial watercourses, although not legally classed as rivers (or streams), may still function as streams, providing both good habitat and water quality that could be retained with some forethought.

### 11.3 Where is the bed of a river?

The RMA defines the bed of a river and lake as:

**“Bed means,—**

*(a) In relation to any river—*

*(i) For the purposes of esplanade reserves, esplanade strips, and subdivision, the space of land which the waters of the river cover at its annual fullest flow without overtopping its banks:*

***(ii) In all other cases, the space of land which the waters of the river cover at its fullest flow without overtopping its banks; and***

*(b) In relation to any lake, except a lake controlled by artificial means,—*

*(i) For the purposes of esplanade reserves, esplanade strips, and subdivision, the space of land which the waters of the lake cover at its annual highest level without exceeding its margin:*

*(ii) In all other cases, the space of land which the waters of the lake cover at its highest level without exceeding its margin; and*

*(c) In relation to any lake controlled by artificial means, the space of land which the waters of the lake cover at its maximum permitted operating level; and*

*(d) In relation to the sea, the submarine areas covered by the internal waters and the territorial sea.”*

For activities in watercourses a[iii] (or b[iii]) and c (in the case of lakes) applies. This can be difficult to identify for small shallow streams or those in steep gullies, as there may be no readily defined edge of bank. Contact Council for assistance in identifying your obligations.

### 11.4 Types of Activities and Methods of Protection

The types of activities which may cause erosion and sediment generation issues in and around watercourses includes:

- Earthworks, recontouring and construction of roads or tracks.
- Sediment removal from streams, stream reprofiling or re alignment.
- Temporary passage across or along watercourses to access other parts of sites during construction.
- Removal and planting of vegetation alongside or within watercourses.
- Piping and infilling of watercourses (this should only occur where a resource consent has been obtained).
- Installation of temporary and permanent structures, such as culverts, bridges and utility pipes.
- Installation of protection structures for bank stability and erosion control (retaining walls, rock rip-rap, etc).
- Installation of temporary or new outlets (eg sediment retention pond outflows or stormwater pipes) that discharge into watercourses.
- Stock access.
- Cultivation (crops and forestry).

Erosion and sediment control measures are not to be constructed in channels having permanent flow. This is because the catchments are too large, the permanent flows limit the effectiveness of any controls, they can impede fish passage and they cause their own effects because of the degree of construction disturbance. Instead the aim is usually to divert flows temporarily around the area of works, allowing for activities to be done 'in the dry'.

The following sections cover the typical methods used when undertaking activities in or around watercourses including:

- Temporary waterway crossings.
- Temporary diversion by damming and piping.
- Temporary diversion by new temporary channel.
- Outlet protection.

Some situations may also require a range of other control measures in addition to those discussed, including those outlined in Chapters 8 and 9. Specialist help may be required in some circumstances. For example, fish and eel recovery may be required for many stream and river works. This process is outlined in the following section.

## 11.5 Eel and fish recovery

Eel and fish recovery is required in all situations where flowing watercourses are diverted during works. In addition, eel and fish recovery will also be required in intermittent watercourses that have ceased flowing and where residual pools are present.

In situations where works are being undertaken in wetted channels, but diversion is not practicable, eel and fish recovery may also be required depending on the site characteristics and the nature of the works.

These situations require differing methodologies for eel and fish recovery which are outlined in the sections below.

In all cases recovery operations should be overseen by an appropriately qualified ecologist and undertaken by persons holding relevant permits to transfer fish (from the Ministry of Primary Industries (MPI) and the Department of Conservation).

In addition, those undertaking electric fishing will also typically be required to hold a licence certifying completion of a NIWA electric fishing training course under health and safety requirements.

### 11.5.1 Eel and fish recovery for watercourse diversions

It is important with any stream work that fish, including eels, are recovered from the intended work area before work begins.

The basic recovery process involves:

1. Isolating the subject stream reach with stop nets or silt fences at upstream and downstream ends prior to damming and pumping or channel diversion
2. Electric fishing the isolated section with 2-3 passes. Use two machines for waterways over 3m wide
3. Once the dams are placed within the isolated area, over-pumping the stream water from the dammed section and electric fishing of any residual ponds, collecting any stranded fish. This process may

need to be repeated depending on the specific project and stream characteristics to maximize fish recovery. This process may involve iwi monitors

4. Avoid predation by eels while holding the recovered fish for transfer by keeping fish and eels over 400mm in separate tanks from those under 400mm long
5. Fish should be kept in suitably large containers, kept shaded and cool, and transferred as soon as possible. Fish should be kept no longer than 6hrs in summer or 12hrs in winter, unless water is kept cool and well aerated. If fish show signs of distress, such as gasping at surface, they should be released immediately.
6. Fish should be released to a suitable location in flowing water in the same waterway where possible. This transfer needs to be overseen by personnel with a licence from the Ministry of Primary Industries.
7. When work is complete and the watercourse bed is reinstated, return the water to the stream by removing the dams and then remove the stop nets/silt fences to allow fish passage back into the isolated area.



Figure 11-2 Fish recovery in Reservoir Creek using electric fishing technique and a recovered eel awaiting transfer

### 11.5.2 Eel and fish recovery and mitigation for works in wetted channels

In some situations diversion of waterways and undertaking works in the dry are not practicable due to waterway size or site characteristics. Ecological sampling should be undertaken to determine the type and abundance of fish populations in the works area to assist in identifying appropriate mitigation methods.

Methods that may be employed to minimise impacts on fish populations include:

- Minimising the area of wetted channel that is disturbed.
- Fish recovery immediately before the works are carried out, including electric fishing and installation of fish stop-nets up and downstream to prevent fish re-entering the work zone.
- Installing sediment curtains or silt fences to minimise sediment transport downstream (refer Chapter 8, section 8.2).
- Using an excavator with a weed rake attachment to allow fish chance to escape back into the water.



- Avoiding the compaction of excavated sediments for at least 24 hours to allow for eel escape or recovery.
- If excavated stream bed sediments are disposed of near or along the channel, benching of disposed sediments towards the watercourse to encourage fish and eel movement back towards the watercourse (eels can move effectively over wetted ground for some distance). Do not place such bed sediment on the landward side of a stopbank as fish will generally only move down-slope.
- If excavated bed sediments are disposed of away from the channel (ie at a designated dump site) – carefully spreading out excavated bank and bed materials at the disposal site to allow for eel and fish search and recovery and transfer back to the watercourse for release.
- Records of fish recovered including basic size classes should be kept and provided to the Resource Scientist responsible for river ecology monitoring.

## 11.6 Temporary watercourse crossings

### 11.6.1 Definition and purpose

A temporary bridge or culvert installed across a watercourse for short term use by construction vehicles.

Temporary watercourse crossings provide a means for construction vehicles to cross watercourses without moving sediment into the watercourse, causing turbidity, or damaging the bed and channel.

### 11.6.2 Conditions where practice applies

Where heavy equipment is required to be moved from one side of a watercourse to the other, or where traffic crosses the watercourse frequently for a short period of time.



Figure 11-3 Temporary culvert crossing

### 11.6.3 Key design criteria

If a watercourse crossing is required, select a location where the potential effects of the crossing (including its construction) are minimised, such as old or existing crossings or areas where the bed is firm aggregates or cobbles rather than muds.

Plan watercourse crossings well before you need them and if possible, construct them during periods of dry weather. Complete construction as rapidly as possible and stabilise all disturbed areas immediately during and following construction. Fish and eel recovery may also need to be undertaken in waterways that are flowing at the time of construction (refer Chapter 11.5).

As well as erosion and sediment control measures, structural stability, utility and safety should also be taken into account when designing temporary watercourse crossings. In addition, consents may be required for the construction of the proposed crossing. Any temporary crossing should be consistent with the technical requirements outlined in the Council's Nelson Tasman Land Development Manual (NTLDM) document.

Do not build a watercourse crossing during the fish migration (particularly upstream migration) or spawning periods for the watercourse. In Tasman the main upstream migration period is in spring from August to November. Inanga spawning occurs from February to May near where streams meet the coast and trout spawning occurs from May to August in inland waterways. For further information refer to Tasman District Council Report # 11001 on Tasman fish species (TDC 2011). The migration and spawning calendars for particular species from the report are reproduced in Appendix 13.12.

The two main types of crossing considered to be good practice are bridges and culverts. Crossings using fords may be applicable in certain circumstances.

### 11.6.3.1 Bridges

Bridges are the preferred temporary watercourse crossing method. They provide the least obstruction to flow and fish migration, cause little or no modification of the bed or banks and generally require little maintenance.

It should be noted, however, that bridges can be a safety hazard if not designed, installed and maintained appropriately. Materials and designs should be adequate to bear the expected loadings.



Figure 11-4 Temporary Bridge Crossing

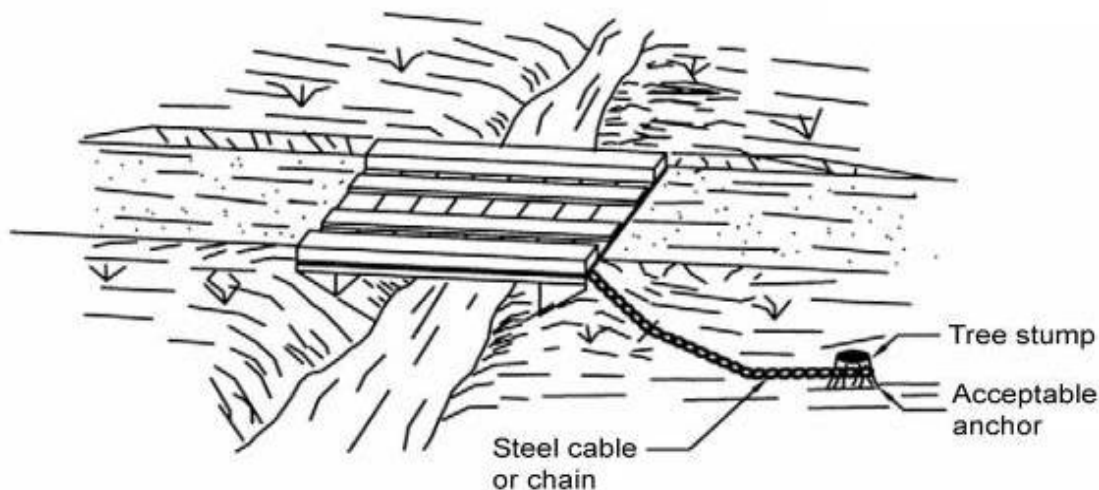

Figure 11-5 Temporary bridge example for small streams (with anchor to retain bridge components during floods)

### 11.6.3.2 Culvert crossings

Culverts are the most commonly used type of temporary watercourse crossing and can be easily adapted to most site conditions.

The installation and removal of culverts can cause damage to watercourses and can also create obstruction to flood flows and fish passage.

When installing a temporary culvert, sizing is important as storm flows could cause erosion or overtop the culvert causing failure of the temporary access.



Figure 11-6 Temporary culvert crossing with the rock protection at the outfall to reduce stream erosion

The sizing of temporary culverts should be determined by following the risk based approach in Appendix 13.7 through selecting an appropriate design storm from Table 13-12 based on works duration and type of receiving environment. For very short duration works (less than two weeks) with Category B or C receiving environments culvert size can be determined using 85% of the channel width at bank full providing appropriate provision is made for overtopping. Consideration should be given to overland flow paths to ensure that larger flows do not cause safety or environmental impacts.

All temporary watercourse culvert crossings should have a contingency plan in place, in the event that a larger than design storm occurs. The plan should include consideration of the following:

- Where feasible removal of the culvert and stabilization of the channel bed to reinstate full channel flows prior to storm events.
- Understanding the flood flow paths around the site, including the potential for flows to take unusual flow paths due to the culverts - if these are retained in place - which may affect adjacent properties differently than normal.
- Scour protection to ensure the integrity of the crossing in the event of overtopping.
- Ensuring all loose building materials and machinery are out of the channel and any flood flow paths prior to storm events occurring.

Even though the culverts are temporary, they need to ensure that fish passage is not impeded during the period of time that the culvert is in the stream - particularly on perennial streams.

This will typically include:

- Placing the invert of the culvert below the bed level and maintaining the same grade in the pipe as the stream channel to avoid changes in bed level and water depth which may create a barrier to fish.
- Using velocity dissipation structures along the culvert invert to provide low velocity areas to allow for fish passage.



Figure 11-7 Culvert with Energy Dissipation Baffles



- For multiple pipe crossings, one pipe should be lower than the rest to maintain deeper water during low flows.
- The invert (base) of box culverts should be sloped to one side to provide a deeper water zone, rather than a thin film of water at low flows.

See the Council's Best Practice Guidelines for Waterway Crossings (TDC 2009) further design guidance on providing fish passage.

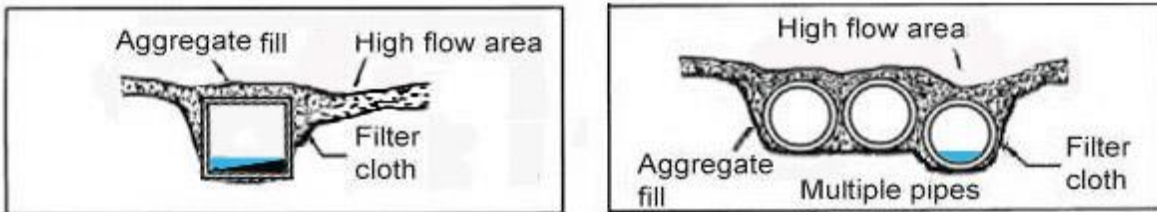

Figure 11-8 Temporary culvert crossings with box culvert and multiple culverts

### 11.6.3.3 Ford crossings

Crossings using constructed ford structures (low water crossings) are not generally considered best practice for temporary or permanent crossings, however in situations where streams are wide and shallow (eg 10m wide and less than 0.5m deep), with rock or gravel substrates, direct fording of the watercourse by vehicles may occur providing adequate sediment control is used to achieve the required water quality standards. For example, a suitable wheel and truck wash facility provided on each bank to remove excess sediment prior to the crossing and stabilisation of the roads entering into and out of the watercourse with aggregate.

Where bed substrates contain more fine sediments and the crossing of the bed is likely to generate sediment discharges, consideration should be given to methods to temporarily stabilise the bed and banks and approval for this obtained from Council. Fords that are unlikely to comply with the permitted activity conditions in the TRMP and NRMP will need resource consent.

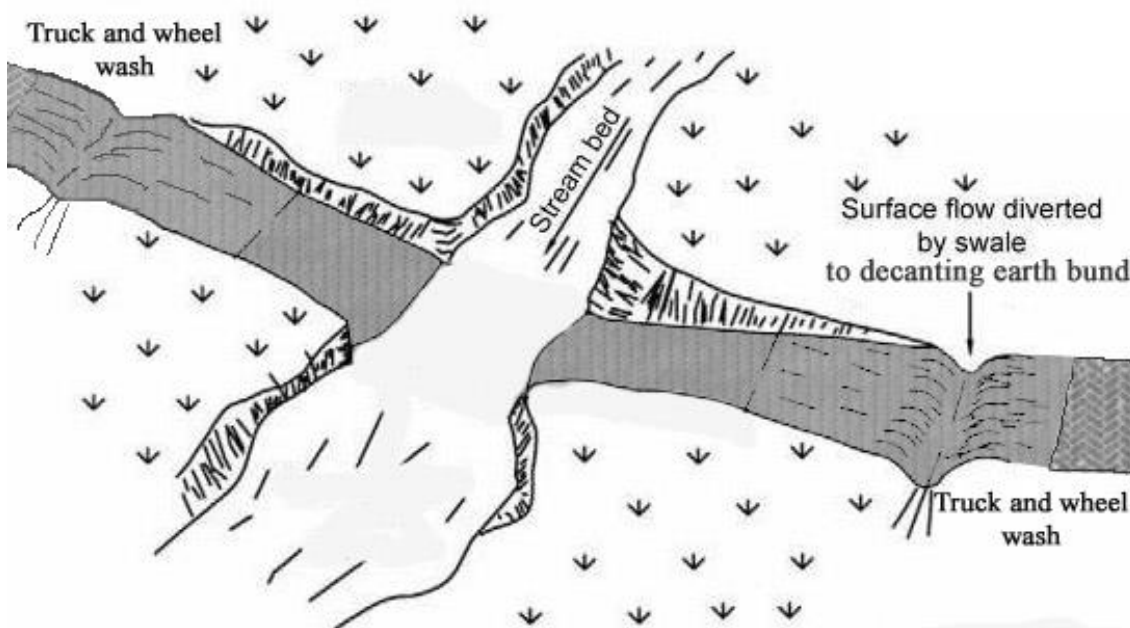

Figure 11-9 Temporary ford with truck and wheel washes

#### **11.6.4 Maintenance of temporary crossings**

Inspect temporary watercourse crossings after rain to check for blockage in the channel, erosion of the banks, channel scour or signs of instability. Make all repairs immediately to prevent further damage to the installation.

#### **11.6.5 Decommissioning of temporary crossings**

When the structure is no longer needed, remove the structure and all material from the site. Immediately stabilise all areas disturbed during the removal process by revegetation and if required, using artificial protection as a short-term control measure until vegetation has established. If possible, keep machinery clear of the watercourse while removing the structure.



## 11.7 Diversion by coffer dam

### 11.7.1 Definition and purpose

Diversion by coffer dam involves a temporary enclosure built within a body of water to allow the enclosed area to be pumped out, creating a dry work environment for the work to proceed. A sufficient width of watercourse is retained to allow normal flows past the works.

### 11.7.2 Conditions where practice applies

Diversions by coffer dam are generally suitable for most small, short duration works. They can be used to allow works to be undertaken within permanent and ephemeral watercourses and on the edges of lakes and estuaries.



Figure 11-10 Aquadam used on the Ruby Bay bypass to isolate an estuary work site

They allow for continued water flow past the works site without the need for continuous high-volume pumping or a new temporary channel. This can reduce costs in terms of fuel or power for pumping and allows for fish passage throughout the duration of the works.

### 11.7.3 Limitations

- Not suitable in areas of high velocity flow unless specifically designed and built of appropriate materials.
- May still require ongoing over pumping if groundwater rises into dammed area or coffer dam leaks (eg when made of sandbags).
- Consideration is required for disposal of sediment laden water from over pumping.
- Works may be difficult to undertake due to the small confined area.

### 11.7.4 Key design and construction criteria

Coffer dams design and construction will depend on the site and situation. Dams can be constructed with stabilised materials such as sandbags, large rock with geo-textile support or other suitable construction materials eg sheet metal or a suitable proprietary (off the shelf) device may be used. The design of the dam should be capable of holding back the incoming flows.

Where fish and eel recovery is required, stop nets or silt fences should be located upstream and downstream to isolate the area to be dammed and initial fish recovery undertaken (refer section 11.5 for the fish recovery process).

Dams are constructed around the area to be worked starting from the upstream side and working progressively downstream to complete the dam. Deployment of proprietary devices should follow the manufactures' instructions. Water remaining within the dammed area is then over pumped to an appropriate dewatering facility (refer 9.6).

If required, the pump intake is retained inside the dammed area to remove water entering the dammed area from leakage through the coffer dam or upwelling from groundwater.

#### 11.7.4.1 Contingency Planning

All watercourse diversions should have a contingency plan in place, in the event that a larger than design storm occurs. The plan should include consideration of the following:

- Where feasible removal of the dam to reinstate complete channel flows prior to storm events.
- Understanding the flood flow paths around the site, including the potential for flows to take unusual flow paths due to the dam - if these are retained in place - which may affect adjacent properties differently than normal.
- Provision for temporary stabilization of the works area prior to any flooding based on forecast warnings. This includes having suitable stabilization materials readily available.
- Ensuring all loose building materials and machinery are out of the channel and any flood flow paths prior to storm events occurring.

#### 11.7.5 Maintenance

Any diversion of a watercourse will require ongoing and vigilant maintenance to minimise erosion and sediment generation.

Key aspects to consider include:

- Integrity of the dam – ensure no erosion or undercutting is occurring.
- Leakage from dams or groundwater into works area.
- Regular monitoring and maintenance of any pump used to dewater the dammed area to ensure continued function at the required capacity.

#### 11.7.6 Decommissioning

Once the works have been completed, the bed in the works area should be reinstated including stabilisation and reshaping of any bare sections of channel to match the cross-section immediately upstream and downstream, reinstatement of similar bed substrate and removal of all materials not required for any installed structures.

Once the bed has been reinstated, progressively remove the coffer dam from the downstream side to allow flows to slowly re-enter the dammed area to minimize erosion and flushing effects or follow the manufactures' instructions for proprietary devices.

## 11.8 Diversion by damming and piping

### 11.8.1 Definition and purpose

Diversion by damming and piping is temporarily used to convey surface water from above a construction activity downstream of that activity. This assists in providing dry working conditions for works within the existing channel.

Damming a stream and pumping the flows around the work site or diverting flows through a gravity fed pipe, back to the stream minimises disturbance considerably compared with diversion by constructing a new temporary channel (refer section 11.9).



Figure 11-11 Temporary Culvert Crossing

### 11.8.2 Conditions where practice applies

Damming and piping diversions are generally suitable for most small streams with relatively low flows. They have less potential effects on the environment and are relatively simple to carry out when compared to temporary waterway diversions using channels (section 11.9).

### 11.8.3 Limitations

The key limitation with damming and pipe diversions is that the stream flow able to be diverted is dependent on the pump size and pipe capacity used. In addition, failure of the pump through malfunction or running out of fuel if the pump is unattended (eg at night) could result in flooding of the works area and generation of considerable sediment. There can also be issues with fish passage affecting the allowed duration or timing of the works (refer to the TRMP and NRMP for relevant rules).



Figure 11-12 Reservoir Creek diversion with intake pipe (upper right) and outlet with energy dissipation (lower right)



#### 11.8.4 Key design and construction criteria

Where fish and eel recovery is required, stop nets or silt fences should be located upstream and downstream to isolate the area to be dammed and initial fish recovery undertaken (refer section 11.5 for the fish recovery process).

Dams are constructed across the watercourse upstream and downstream of the proposed works area. Dams can be constructed with stabilised materials such as sandbags, large rock with geo-textile support or other suitable construction materials. The dam should be capable of holding back the incoming flows.

If required a pump intake is installed in the upper dam and sufficient hose/pipe length should be available to reach below the extent of instream works. The pump intake should be placed in a drum with a screen placed on the inlet to ensure that the velocity over the screen is less than 0.3m/sec to prevent sucking up aquatic life and minimise the possibility of sucking sediment from the bottom of the dam.

The pump and pipe should be sized following the risk-based approach in Appendix 13.7 through selecting an appropriate design storm from Chapter 13, Table 13-12 based on works duration and type of receiving environment.

The outlet should be directed to a stabilised area with an energy dissipater, such as riprap boulders or similar to avoid scour of soft banks or bed.

Eel and fish recovery should be undertaken as the isolated area of works is pumped dry. The recovery process is outlined in section 11.5.

For projects longer than five days duration, works will need to cease and flows be reinstated down the main channel to allow for fish passage to occur, unless resource consent has been obtained (refer the diversion of water by structures rule in the TRMP which requires that diversions do not reduce the capacity for fish and eels to migrate past any structure for periods exceeding five days per any 20-day period).



Figure 11-13 Pipe diversion during Ruby Bay Bypass (D.Shaw)

##### 11.8.4.1 Contingency Planning

All watercourse diversions should have a contingency plan in place, in the event that a larger than design storm occurs. The plan should include consideration of the following:

- Where feasible removal of the dams and pumps to reinstate channel flows prior to storm events.
- Understanding the flood flow paths around the site, including the potential for flows to take unusual flow paths due to the dams - if these are retained in place -which may affect adjacent properties differently than normal.
- Provision for temporary stabilization of the works area prior to any flooding based on forecast warnings. This includes having suitable stabilization materials readily available.
- Ensuring all loose building materials and machinery are out of the channel and any flood flow paths prior to storm events occurring.

### 11.8.5 Maintenance

Any diversion of a watercourse will require ongoing and vigilant maintenance to minimise erosion and sediment generation. This is particularly important where pumps are used to maintain the diversion flow.

Key aspects to consider include:

- Integrity of the dams – ensure no erosion or undercutting is occurring.
- Regular monitoring and maintenance of the pump to ensure continued function at the required capacity.
- Scour occurring where the piped flow re-enters the original channel.
- Leakage from pipes back into works area.

### 11.8.6 Decommissioning

Once the works have been completed, the bed in the works area should be reinstated including stabilisation and reshaping of any bare sections of channel to match the cross-section immediately upstream and downstream, reinstatement of similar bed substrate and removal of all materials not required for any installed structures.

Once the bed has been reinstated the following steps should be taken to decommission the diversion:

1. Retain upstream and downstream fish nets and silt fences in place during decommissioning
2. While still pumping flows past the isolated area, remove the downstream dam
3. Remove the upstream dam and reduce the rate of pumping to achieve low flows through the works area to minimize erosion and flushing effects (if decommissioning is done during a period of low flows reduced pumping may not be needed)
4. Once water is flowing through the site, turn off the pump and remove all equipment from the watercourse, including the upstream and downstream fish nets / silt fences.



## 11.9 Diversion by temporary channel

### 11.9.1 Definition and purpose

Waterway diversion by temporary channel creates an alternative flow path for the waterway that allow works to occur within the original watercourse channel under dry conditions.

### 11.9.2 Conditions where practice applies

Diversions by temporary channel can be used to allow any works to be undertaken within permanent and ephemeral watercourses.

They are particularly useful where longer duration works are undertaken and maintaining fish passage for the duration of the works is important or where waterway flows are in excess of practical pumping capacities or the costs of powering pumping are too high.

### 11.9.3 Key design criteria

Divert all flow via a stabilised system around the area of works and discharge it back into the channel below the works to avoid scour of the channel bed and banks.

The stabilised system can include an excavated channel, marine ply flume or similar structure.

The diversion channel or structure should be sized following the risk-based approach in Appendix 13.7 through selecting an appropriate design storm from Table 13-12 based on works duration and type of receiving environment.

The process for excavating a temporary channel is outlined below:

#### 11.9.3.1 Step 1

The diversion channel should be excavated leaving a plug at each end so that the watercourse does not breach the diversion while it is being constructed.

The diversion channel should be appropriately stabilised to ensure it does not become a source of sediment. Suitable geotextile cloth (refer Section 8.3.5) should be anchored in place to the manufacturers' specifications, which will include trenching into the top of both sides of the diversion channel to ensure that the fabric does not rip out.



Figure 11-15 Use of Marine Ply flume as a Stream Diversion

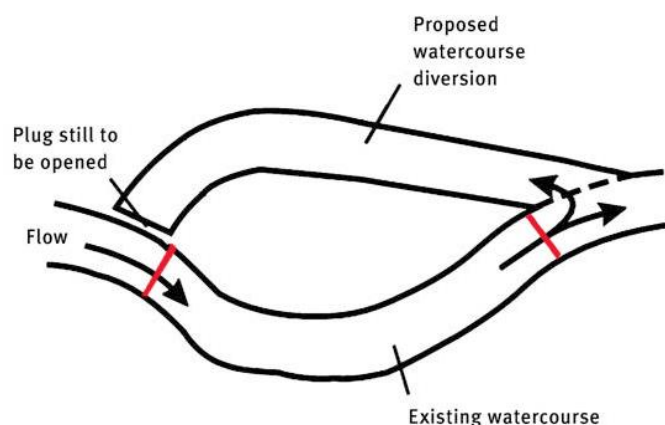

Figure 11-16 Diversion channel prior to upstream plug removal with fish stop nets (red)

Where fish recovery is required, stop nets or silt fences (refer Figure 11-16) should be located upstream and downstream to isolate the area to be dammed and initial fish recovery undertaken (refer section 11.5 for the fish recovery process).

The downstream plug is then opened to allow water to flow up the new channel, keeping some water within the channel to reduce problems when the upstream plug is excavated. Open the upstream plug and allow water to flow into the new channel.

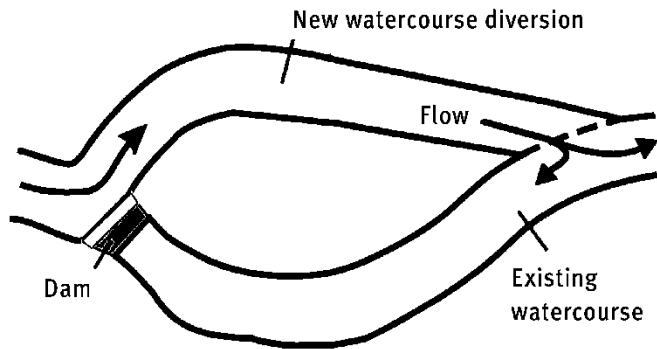

Figure 11-17 Opening up bypass channel and damming off existing one

11.9.3.2 Step 2

A non-erodible dam should be immediately placed in the upstream end of the original channel. The dam should be constructed as specified in Figure 11-17, or use an approved proprietary device.

11.9.3.3 Step 3

A non-erodible downstream dam should then be installed in the original channel to prevent backflow into the construction area.

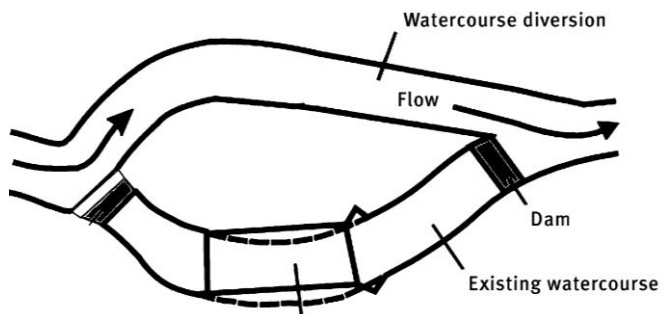

Figure 11-18 Temporary Watercourse

If there are fish trapped in the original watercourse as a result of the diversion, those fish should be captured and relocated to the live section of the watercourse (refer section 11.5).

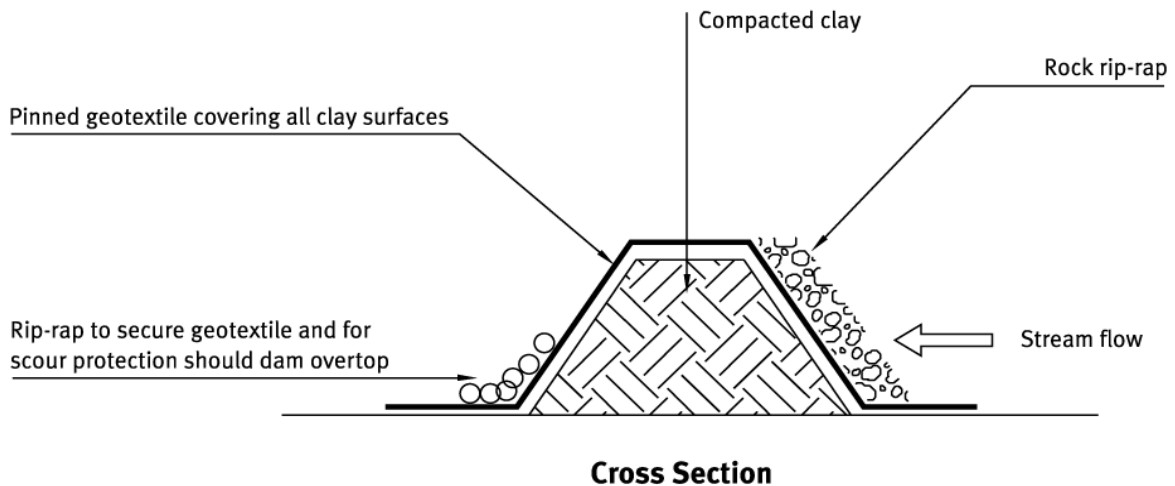

Figure 11-19 Downstream damming of original watercourse to isolate works area

#### 11.9.3.4 Step 4

The isolated area of works on the original watercourse is then drained by pumping to a sediment retention pond where treatment of the ponded water can occur prior to discharge to the live section of the watercourse.

Works can then be undertaken 'in the dry' within the isolated works area.

#### 11.9.3.5 Contingency Planning

All watercourse diversions should have a contingency plan in place, in the event that a larger than design storm occurs. The plan should include consideration of the following:

- Where feasible removal of the dams and reinstatement of flows in the original channel prior to storm events.
- Understanding the flood flow paths around the site, including the potential for flows to take unusual flow paths due to the dams or temporary channel - if these are retained in place - which may affect adjacent properties differently than normal.
- Provision for temporary stabilization of the works area prior to any flooding based on forecast warnings. This includes having suitable stabilization materials readily available.
- Ensuring all loose building materials and machinery are out of the channels and any flood flow paths prior to storm events occurring.



Figure 11-20 Temporary diversion and culvert while a new permanent culvert is constructed

#### 11.9.4 Maintenance

Any diversion of a watercourse will require ongoing and vigilant maintenance to minimise erosion and sediment generation. Take particular notice of the following signs of potential problems developing and make repairs immediately:

- The geotextile lining in the temporary channel ripping.
- Scour occurring where the flow re-enters the original channel.
- Undercutting of the diversion lining.
- Leaking or erosion of the dams.

#### 11.9.5 Decommissioning

Once the works have been completed, the bed in the works area should be reinstated including stabilisation and reshaping of any bare sections of channel to match the cross-section immediately upstream and downstream, reinstatement of similar bed substrate and removal of all materials not required for any installed structures.

Once the bed has been reinstated, the downstream dam should be removed first, allowing water to flow back into the original channel.

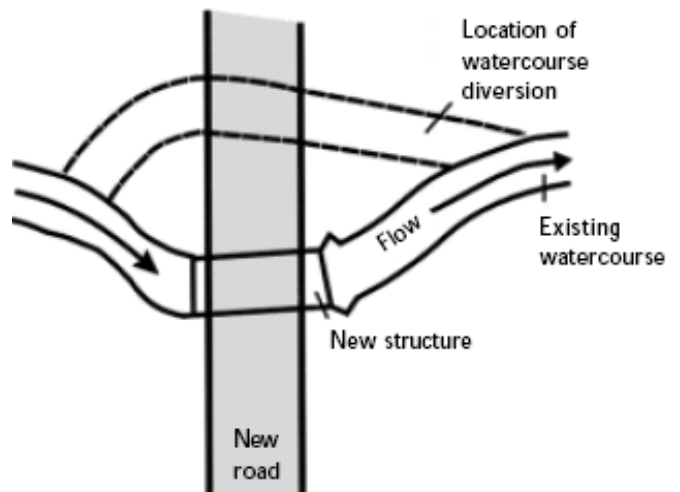

Figure 11-21 Re-establishment of flow in original channel

The upstream dam is then removed, and both ends of the diversion channel filled in with non-erodible material to prevent flows going back down the diversion.

Any sediment-laden water in the temporary diversion channel should be pumped to a sediment retention pond for treatment. The diversion channel should then be filled in and stabilised.

## Chapter 12

# Utilities Installation and Trenching

NELSON TASMAN  
**EROSION AND SEDIMENT  
CONTROL GUIDELINES**

JULY 2019







## TABLE OF CONTENTS

<b>12</b>	<b>NON-SEDIMENT CONTAMINANTS .....</b>	<b>1</b>
	<b>12.1 Introduction .....</b>	<b>1</b>
	<b>12.2 Planning and design requirements .....</b>	<b>1</b>
	<b>12.3 Construction requirements .....</b>	<b>2</b>

### LIST OF FIGURES

Figure 12-1	Pipe installation being dewatered to decanting earth bund .....	1
Figure 12-2	Typical trenching methodology .....	2

## 12 NON-SEDIMENT CONTAMINANTS

### 12.1 Introduction

Unless correctly planned and managed, the installation of services and utilities such as electricity, gas, water, sewer and telecommunications can result in significant disturbance to the ground surface. Soil erosion and sedimentation are common environmental impacts of trenching and dewatering of trenches.



Figure 12-1 Pipe installation being dewatered to decanting earth bund

Installation of these utilities and services in a residential subdivision generally takes place towards the end of the bulk earthworks phase. Trenching works may, therefore, traverse areas that have already been stabilised, and, in some cases, areas where sediment control measures have already been decommissioned. The trenches are often long and can cut across different water catchments. The earthworks are usually fairly minor in any one area but have a cumulative effect. The works are often undertaken along roads and close to stormwater inlets.

Pumping groundwater and rainwater out of trenches generates sediment-laden water that can be difficult to treat, particularly in the roadway where these works are usually done. Refer to Chapter 9, section 9.6 for advice on dewatering.

### 12.2 Planning and design requirements

Consider the following points when planning for installation of utilities:

- Install reticulation systems for water supply, stormwater and sanitary services and for other services and utilities at the same time as the road works.
- Co-ordinate installation of services and utilities with all relevant service providers and authorities, and, where possible, use common trenching.
- Make sure that trenching operators working in a larger site are aware of the erosion and sediment control plan for the overall site and understand that they should comply with its provisions, as well as with any specific erosion and sediment control requirements for their work.
- Installing utilities across flowing watercourses will require specific design and use of directional boring or waterway diversion methods outlined in Chapter 11.

- In areas where ephemeral water is likely to concentrate, create a dam above the site with sandbags or similar, carry out the works and reinstate and stabilize the surface.
- Plan the works so as to minimise both the extent and duration of site disturbance, particularly in high-risk areas close to watercourses and on slopes steeper than 10%.
- When trenching has been completed independent of other activities onsite, plan for progressive stabilisation and restoration of disturbed areas.
- Where practicable, plan and undertake works in appropriately sized stages so that trenching is not open for a period longer than three days and can be stabilised in a rolling manner.

### 12.3 Construction requirements

Address the aspects below when undertaking installation of utilities:

- If trenching works affect pre-existing erosion and sediment control measures, those measures should be carefully removed and then immediately reinstated at completion of the works.
- Additional erosion and sediment control contingency measures will usually be needed for the duration of trenching activities, and until the original measures are reinstated or replaced.
- Avoid opening trenches when there is a forecast risk of high rainfall.
- Divert above-site water away from work areas with temporary contour drains (Chapter 8, section 8.2.2); don't allow the trench excavation to concentrate or convey runoff.
- Topsoil and spoil should be stockpiled separately on the upslope side of the trench. Do not put stockpiles of topsoil, spoil or bedding material in overland flow paths or within 1m of a hazard area such as kerb and channels, stormwater inlets, paved footpaths or driveways.
- Minimise soil loss by protecting all stockpiles with covers such as geotextile fabric.
- Dewatering of trenches should not pollute any stormwater system or downstream watercourse; use appropriate dewatering methods (refer Chapter 9, section 9.6) or pump sediment-laden water to a tanker for appropriate offsite disposal.
- Leave the final level in the back filled trench slightly above that of the adjacent ground to allow for subsequent settlement, but make sure this does not cause concentration of overland flow.
- Remove excess spoil and/or bedding material from the site as soon as work is completed, or immediately incorporate into other works onsite.

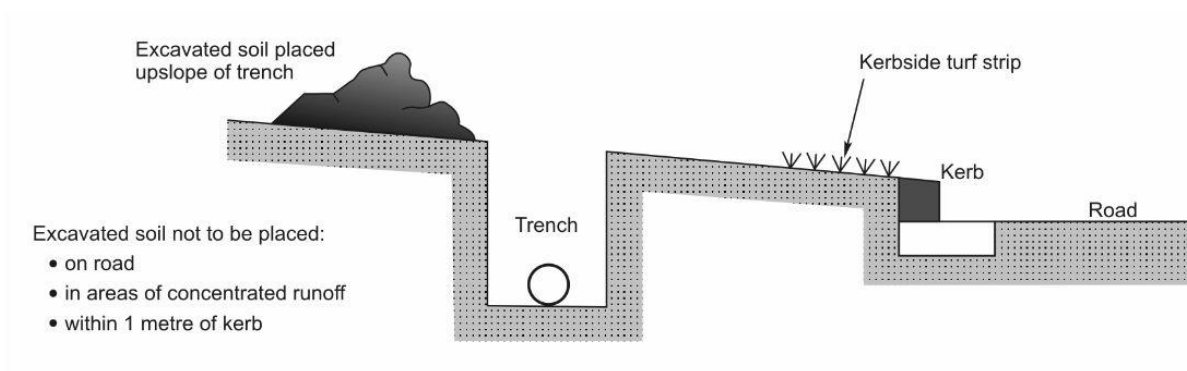

Figure 12-2 Typical trenching methodology

# Chapter 13

## Appendices

NELSON TASMAN  
**EROSION AND SEDIMENT  
CONTROL GUIDELINES**

JULY 2019







## TABLE OF CONTENTS

<b>13</b>	<b>APPENDICES</b> .....	<b>1</b>
13.1	<b>Glossary</b> .....	<b>2</b>
13.2	<b>Erosion and Sediment Control Plan Symbols</b> .....	<b>8</b>
13.3	<b>Accidental Discovery Protocol - Land Disturbance for Construction Sites / Building Sites</b> .....	<b>9</b>
13.3.1	Process for follow for any Māori cultural site find .....	10
13.3.2	Process when there is a discovery of kōiwi tāngata/human remains.....	11
13.4	<b>Ten Commandments of Erosion and Sediment Control</b> .....	<b>12</b>
13.5	<b>Slope Conversion and Terminology</b> .....	<b>14</b>
13.6	<b>Universal Soil Loss Equation Information</b> .....	<b>15</b>
13.6.1	Rainfall Erosion Index (R in J/hectare) .....	15
13.6.2	Soil Erodibility Factor (K in tonnes/unit of R) .....	16
13.6.3	Slope Length and Steepness Factor (LS - dimensionless) .....	18
13.6.4	Ground Cover Factor (C) and Roughness Factor (P) .....	19
13.6.5	Estimating Sediment Yield.....	20
13.6.6	Area of Exposed Soil (Sa in hectares) .....	20
13.6.7	Sediment Delivery Ratio (SDR, 0.0 – 1.0).....	20
13.6.8	Sediment Control Efficiency (SCE in %) .....	20
13.6.9	Duration of Exposure (D in years) .....	21
13.6.10	USLE and Sediment Yield - Example Calculation .....	21
13.7	<b>Design of Erosion and Sediment Controls</b> .....	<b>22</b>
13.7.1	Introduction .....	22
13.7.2	Storage Volume Sizing for Sediment Control Performance .....	22
13.7.3	Contributing Catchment Area (A) .....	23
13.7.4	Runoff Coefficient (C) .....	23
13.7.5	Soil Type.....	24
13.7.6	Ground Cover .....	25
13.7.7	Selection of Runoff Coefficient (C) .....	25
13.7.8	Rainfall Intensity (i) .....	26
13.7.9	Storm size selection .....	26
13.7.10	Example calculation.....	28
13.7.11	HIRDS website .....	29
13.8	<b>Tasman/Nelson region fish migration and spawning calendars</b> .....	<b>31</b>
13.9	<b>Discharge design for T-bar floating decant</b> .....	<b>33</b>
13.9.1	Discharge rate example calculation .....	33
13.10	<b>Bibliography</b> .....	<b>34</b>

## LIST OF TABLES

Table 13-1	Standard Symbols for use on Erosion and Sediment Control Plans .....	8
Table 13-2	Slope conversion table (percent-ratio-degrees) .....	14
Table 13-3	K Value Correction Factor .....	17
Table 13-4	for Determining Slope Length and Steepness Factor (LS).....	19
Table 13-5	USLE C and P Factors .....	20
Table 13-6	Sediment Delivery Ratios .....	20
Table 13-7	Sediment Control Efficiencies .....	21
Table 13-8	Example USLE Calculation Summary .....	21
Table 13-9	Slope conversion table (percent, ratio and degrees).....	24
Table 13-10	Soil Types .....	24
Table 13-11	Representative C (runoff coefficients) values for different soil types and slope.....	26
Table 13-12	Receiving environments and design storms.....	27
Table 13-13	Fish migration calendar for the Tasman District .....	31
Table 13-14	Fish spawning calendar for Tasman District.....	32

## LIST OF FIGURES

Figure 13-1	Nomograph for Estimating K Values .....	16
Figure 13-2	HIRDS Webpage Example.....	30
Figure 13-3	Sediment Pond with Floating Decants also showing Live Storage .....	33

## 13 APPENDICES

These appendices include the following:

- Glossary
- Erosion and Sediment Control Plan Symbols
- Accidental Discovery Protocols
- Ten Commandments of Erosion and Sediment Control
- Slope conversion terminology and figure
- Universal Soil Loss Equation
- Design of Erosion and Sediment controls
- Tasman fish migration and spawning calendars
- Discharge Design for T-bar floating decant
- Bibliography.

## 13.1 Glossary

Term	Definition
AEP - Annual Exceedance Probability	Is the probability of an event occurring or being exceeded in any given year. Expressed as a percentage and generally used in hydrology to define rainstorm intensity and frequency. For example, a five percent AEP event has a five percent chance of being exceeded in any one year. A five percent AEP event expresses approximately the same sized event as a twenty-year return period event.
Anti-seep collar	An impermeable barrier, usually of concrete, constructed at intervals within the zone of saturation along the conduit of a primary outlet pipe to increase the seepage length along the conduit and, thereby prevent piping or seepage in the compacted fill material along the outside of the pipe.
Area of disturbance	The area of soil exposed as a result of the development process.
ARI - Average Recurrence Interval	Is the average time between events, taken over a long time (eg 1000yrs). ARI is the same as “return period” eg a 100-year return event is the same as a 100yr ARI event. Keep in mind that a “1 in 100” year event means there is a 1 per cent chance of the event occurring in a single year, not that the event only occurs once every 100 years.
Baffles	Semi-permeable or solid barriers placed in a sediment retention pond to deflect or regulate flow and effect a more uniform distribution of velocities, hence creating better settling conditions.
Batter	A constructed slope of uniform gradient.
Best practicable option (BPO)	Best practicable option. In relation to a discharge of a contaminant, BPO means the best method for preventing or minimising the adverse effects on the environment having regard, among other things, to: <ul style="list-style-type: none"> <li>(1) the nature of the discharge or emission and the sensitivity of the receiving environment to adverse effects;</li> <li>(2) the financial implications, and the effects on the environment, of that option when compared with other options; and</li> <li>(3) the current state of technical knowledge and the likelihood that the option can be successfully applied.</li> </ul>
Bulk earthworks	This term is generally used to describe the cut to fill earthworks required to re-grade an area. It also applies to larger-scale earthworks such as for building excavations.
Catchment	A geographical unit within which surface runoff is carried under gravity by a single drainage system to a common outlet or outlets. Also commonly referred to as a watershed or drainage basin.
Catchpit	Small chamber incorporating a sediment trap that runoff flows through before entering a reticulated stormwater system (also termed a sump).
Channel	That part of a watercourse system where normal flow is contained. The channel is generally incised into the floodplain and for many of the stable stream systems in New Zealand can be defined in capacity as being just able to accommodate the annual return period flow (one hundred percent AEP) without overtopping. Also refers to an artificial conduit such as a ditch excavated to convey water.
Clay (soils)	A mineral soil consisting of particles less than 0.002mm in equivalent diameter. A soil texture class.
Clean water	Any water that has not been polluted by construction activities and has no visual signs of suspended solids, e.g. Overland flow (sheet or channelled) originating from stable well-vegetated or armoured surfaces.
Cohesion	The capacity of a soil to resist shearing stress, exclusive of functional resistance.



Term	Definition
Compaction	For construction work in soils, engineering compaction is any process by which the soil grains are rearranged to decrease void space and bring them into closer contact with one another, thereby increasing the weight of solid material per unit of volume, increasing their shear and bearing strength and reducing permeability.
Concentrated flow	The accumulation of sheet flow into discrete rills, gullies or channels, significantly increasing erosive forces.
Conduit	Any channel intended for the conveyance of water, whether open or closed.
Contaminant	Includes any substance (including gases, liquids, solids, and micro-organisms) or energy (excluding noise) or heat, that either by itself or in combination with the same, similar, or other substances, energy, or heat: <ul style="list-style-type: none"> <li>(a) When discharged into water, changes or is likely to change the physical, chemical, or biological condition of water; or</li> <li>(b) When discharged onto or into land or into air, changes or is likely to change the physical, chemical, or biological condition of the land or air onto or into which it is discharged.</li> </ul>
Contour	A line across a slope connecting points of the same elevation.
Contributing catchment	All of the drainage area that contributes to the flow into a treatment device. A contributing drainage area can include both clean and sediment-laden water flows. Commonly referred to as the catchment area of a device.
Cumulative effect	The combination of discrete isolated effects, the sum of which can have a major long-term detrimental impact.
Dam	A barrier to confine or raise water for storage or diversion, to create a hydraulic head, to prevent gully erosion, or to retain soil, rock or other debris.
Decant rate	The rate at which surface water is decanted from a sediment retention pond.
Deposition	The accumulation of material that has settled because of reduced velocity of the transporting agent (water or wind).
Dewatering	The removal of impounded water, generally by pumping.
Disturbed area	An area of exposed soil.
Diversion	A channel or bund constructed to convey concentrated flow.
Drainage	The removal of excess surface water or groundwater from land by means of surface or subsurface drains.
Ephemeral watercourse	A watercourse that only flows during or following more intensive rainstorms such as grassland swales and dry gullies.
Erodible	An erodible soil is a soil that is readily entrained (moved) by actions such as raindrop impact, overland flow or wind.
Erosion and Sediment Control Plan (E&SCP)	A detailed plan normally prepared by the developer's engineer that details the way erosion is to be minimised and the treatment of sediment-laden overland flow that is to be undertaken.
Erosion control blankets	Manufactured blankets and matting of either synthetic or natural fibre used to minimise surface erosion by protecting soil from raindrop impact and shallow sheet flows. Similar to but lighter and less durable than erosion-control mats.
Erosion control matting	Manufactured matting of either synthetic or natural fibre used to minimise surface erosion by concentrated flows and, in some cases, to promote revegetation.
Erosive power	Refers to the ability of erosional agents such as wind or water to cause erosion. Not to be confused with erodible, as a quality of soil.
Erosive velocities	Velocities that are high enough to wear away the land surface. Exposed soils erode faster than stabilised soils. Erosive velocities vary according to the soil type, slope, and structural or vegetative stabilisation used to protect the soil.
Estuary	Area where freshwater meets saltwater, where the tide meets the river current (e.g. Bays, mouths of rivers, salt marshes and lagoons). Estuaries serve as

Term	Definition
	nurseries and spawning and feeding grounds for large groups of marine life and provide shelter and food for birds and wildlife. Estuaries are typically low energy systems where sediment readily settles.
Evapo-transpiration	A measure of water movement into the atmosphere from plants, waterways and soil being the sum of surface evaporation and plant transpiration.
Emergency spillway	A sediment retention pond or dam spillway designed and constructed to discharge flow in excess of the structure's primary spillway design discharge.
Energy dissipator	A designed device such as an apron of rip-rap or a concrete structure placed at the end of a water conduit such as a pipe, paved ditch or flume for the purpose of reducing the velocity and energy of the discharged water.
Fill	Earth placed (normally under a strict compaction regime) to raise the land surface.
Filter fabric	A woven or non-woven, water-permeable geotextile made of synthetic products such as polypropylene used for such purposes as preventing clogging of aggregate by fine soil particles. Refer Geotextile fabric.
Flocculation	The process whereby fine particles suspended in the water column clump together and settle. In some instances, this can occur naturally, such as when fresh clay-laden flows mix with saline water, as occurs in estuaries. Flocculation can be used to promote rapid settling in sediment retention ponds by the addition of flocculating chemicals (flocculants).
Flume	A high-velocity, open channel for conveying water to a lower level without causing erosion. Also referred to as a chute, although, technically, a chute is part of a flume; namely, the steeply inclined section of a flume or other similar hydraulic structure, between the inlet and the outlet, that conveys flows directly from one level to another.
Geosynthetic erosion control systems (GECS)	The artificial protection of erodible channels and slopes using artificial erosion control material such as geosynthetic matting, geotextiles or erosion matting. Also see Erosion control blankets and Erosion control matting.
Geotextile fabric	A woven or non-woven, impermeable or semi-permeable material generally made of synthetic products such as polypropylene and used in a variety of engineering, stormwater management, and erosion and sediment control applications.
Grade	<p>(1) The slope of a road, channel or natural ground.</p> <p>(2) The finished surface of a channel bed, road bed, top of embankment or bottom of excavation.</p> <p>(3) Any surface prepared for the support of construction like paving or for laying conduit.</p> <p>(4) To finish the surface of a channel bed, road bed, top of embankment or bottom of excavation.</p>
Gravel	Aggregate consisting of mixed sizes of 5mm to 75mm particles which normally occur in or near old streambeds and have been worn smooth by the action of water.
Headwater	The source of a watercourse; the water upstream of a structure or point on a watercourse.
Hydrology	The science of the behaviour of water in the atmosphere, on the surface of the earth and underground.
Hydroseeding	The pressure-spraying of a slurry of water, seed, fertiliser and paper or wood pulp over a surface to be revegetated.
Impervious	Not allowing infiltration of water.
Intermittent Stream	A stream or stream reach which carries water a considerable portion of the time, but which ceases to flow occasionally or seasonally because bed seepage and evapo-transpiration exceed the available water supply. Those that maintain a

Term	Definition
	<p>series of discrete pools that provide habitat for the continuation of the aquatic ecosystem are important for maintaining aquatic health.</p> <p>'Intermittent' in the NRMP means a river or stream that is dry at certain times and has one or more of the following characteristics:</p> <p>It is mapped as riparian overlay in the NRMP maps or listed as conservation priority 1 or 2 in Table 6.1 of NRMP Appendix 6, or</p> <p>Has natural stable pools having a depth at their deepest point of not less than 150mm and a surface area not less than 2m<sup>2</sup> present throughout the period commencing 1 February and ending 30 April of any year.</p>
Land disturbance	The destruction or removal of vegetation, soil disturbance, or earthworks.
Level spreader	A device used to convert concentrated flow into sheet flow.
Mitigation	Measures taken to off-set adverse environmental effects.
Mulch	Covering on surface of soil to protect it and enhance certain characteristics, such as protection from raindrop impact and improving germination. Mulching can be extended to include gravelling of compound areas, haul roads and access tracks.
Overland flow path	The route of concentrated flow.
Perennial Stream	A permanently flowing stream that normally maintains water in its channel throughout the year, but may dry up in extreme conditions
Permeability (soil)	The rate at which water will move through a saturated soil.
Permitted activities	Activities described in the Resource Management Act, regulations, or a plan or proposed plan that does not require a resource consent if it complies with the standards, terms, or conditions, if any, specified in the plan or proposed plan.
Pervious	Allowing movement of water.
Poly aluminium chloride (PAC)	A long chain chemical that is used as a flocculant in certain situations.
Primary spillway	The riser inlet within a sediment retention pond. See Riser.
Rainfall intensity	The volume of rainfall falling in a given time. Normally expressed as mm/hour.
Receiving environment	The ultimate destination of a discharge, whether via a reticulated stormwater system, from surface runoff or via direct discharge.
Rehabilitation	Restoration to as near to pre-disturbance conditions as possible. This may entail such measures as revegetation for erosion control, enhancement planting, modification and armouring of watercourses.
Return period	Refer Average Recurrence Interval (ARI)
Revegetation	The establishment of vegetation to stabilise a site.
Riser	In a sediment retention pond, a vertically placed pipe to which decant pipes are attached, which forms the inlet to the primary spillway.
River	A continually or intermittently flowing body of fresh water; and includes a stream and modified watercourse; but does not include any artificial watercourse (including an irrigation canal, water supply race, canal for the supply of water for electricity power generation, and farm drainage canal).
Scour	The erosive, tractive or digging action of flowing water; the downward or lateral erosion caused by water. Channel-forming stream scour is caused by the sweeping away of mud and silt from the outside bank of a curved channel (meander), particularly during a flood.
Sediment	Solid material, both mineral and organic, that is in suspension, is being transported, or has been moved from site of origin by air, water, gravity, or ice and has come to rest on the earth's surface either above or below water.

Term	Definition
Sediment delivery ratio	The proportion of the soil eroded from within a catchment area that actually reaches sediment treatment controls or water bodies.
Sediment yield	The quantity of sediment discharged from a particular site or catchment in a given time, measured in dry weight or by volume. When erosion and sediment control measures are in place, sediment yield is the sediment discharged from the site after passing through those measures.
Settling	The downward movement of suspended solids through the water column.
Shear strength	The ability to resist shear (slip) forces.
Sheet flow	Shallow dispersed overland flow.
Shutter boards	Plywood or similar sheeting supported by light timber framing normally used for boxing concrete forms.
Silt	A soil consisting of particles between 0.05 and 0.002 millimetres in equivalent diameter; a soil textural class.
Silt loam	A soil textural class containing a large amount of silt and small quantities of sand and clay.
Silty clay	A soil textural class containing a relatively large amount of silt and clay and a small amount of sand.
Slope	Degree of deviation of a surface from the horizontal, measured as a numerical ratio, as a percent, or in degrees. Expressed as a ratio, the first number is the horizontal distance (run) and the second number is the vertical distance (rise), eg 2h:1v. A 2:1 slope is a fifty percent slope or a slope of 26.57 degrees. A 90° slope is vertical (maximum) and a 45° slope is a 1:1 slope.
Small site	Small areas of earth disturbance such as a residential building site (dwelling and surrounds) that normally do not require a resource consent for land disturbance from Tasman District Council.
Soil	The unconsolidated mineral and organic material on the surface of the earth that serves as a natural medium for the growth of land plants. Earth and rock particles resulting from the physical and chemical disintegration of rocks, which may or may not contain organic matter. Includes fine material (silts and clays), sand and gravel.
Soil structure	Soil structure reflects the pore space within a soil available for aeration and storage of water. It is a measure of bulk density, and as a rule the higher the soil bulk density the poorer the structure. The combination or arrangement of primary soil particles into secondary particles, units or peds. Good soil structure is important for plant growth.
Soil texture	The relative proportions of various particle sizes in a soil material.
Stabilisation	Providing adequate measures, vegetative and/or structural that will protect exposed soil to prevent erosion.
Staging of construction	The completion of bulk earthworks in successive time phases to minimise the area of bare earth exposed at any one time.
Subsoil	The B-horizons of soils with distinct profiles. In soils with weak profile development, the subsoil can be defined as the soil below the ploughed soil (or its equivalent of surface soil), in which roots normally grow.
Sump	Small chamber incorporating a sediment trap that runoff flows through before entering a reticulated stormwater system (also termed a catchpit).
Surface runoff	Rain that runs off rather than being infiltrated into or retained on the surface on which it falls.
Surface water	All water with its surface exposed to the atmosphere.
Suspended solids	Solids either floating or suspended in water.

Term	Definition
Swale	A constructed, elongated depression in the land surface that can be seasonally wet, is usually heavily vegetated, and is normally without flowing water. Swales conduct stormwater into primary drainage channels and can provide some pollutant retention and groundwater recharge.
Tackifier	A compound that is added to straw mulch to bind it together and prevent it being blown around by the wind.
Temporary watercourse crossing	A stable watercourse crossing that is installed for the duration of an operation and is removed in its entirety at the completion of the operation.
Tensile strength	Resistance to elongation and tearing.
Time of concentration	The time for runoff to flow from the most remote part of the drainage area to the outlet.
Toe (of slope)	Where the slope stops or levels out. Bottom of the slope.
Topsoil	Fertile or desirable soil material (suitable organic and structural properties) used to top-dress road banks, subsoils, parent material, etc., to provide a suitable medium for plant growth.
Treatment Train	A treatment train comprises a series of best management practices (structural and non-structural) and/or natural features, each planned to treat a different aspect of pollution prevention, that are implemented in a linear fashion to maximise pollutant removal.
Universal soil loss equation (USLE)	An equation used for the design of a water erosion control system $A = RKLSCP$ where: A = the soil loss in tonnes per ha per annum; R = the rainfall factor; K = the soil erodibility factor; LS = the slope length and gradient factor C = the vegetation factor; P = the surface roughness factor.
Water body	Any type of surface water such as watercourses, lakes and wetlands.
Watercourse	Any pathway for concentrated overland flow, including rivers, streams and ephemeral channels.
Water table	The upper surface of the free groundwater in a zone of saturation; locus of points in soil water at which hydraulic pressure is equal to atmospheric pressure. (not to be confused with a 'water table drain')
Water table drain	A drain that parallels a carriageway to drain surface and subsurface water from the road formation.
Wetland	Includes permanently or intermittently wet areas, shallow water, and land water margins that support a natural ecosystem of plants and animals that are adapted to wet conditions.



### 13.2 Erosion and Sediment Control Plan Symbols

Erosion and Sediment Control Plans (E&SCP) are expected to be of a proportionate scale to that of the project works and erosion and sedimentation risk. The following symbols are intended to provide a consistent basis for production of erosion and sediment control plan maps and provide spatial references for associated text in written methodologies..

Table 13-1 Standard Symbols for use on Erosion and Sediment Control Plans

Map feature	Symbol	Map feature	Symbol	Map feature	Symbol
North arrow		Turfing		Historical / Cultural Sites	
ESC unique identifying numbers		Geotextile / geosynthetic control system		Natural Features	
Extent of land disturbance		Dust control		Site Entranceways	
Topsoil / materials stockpiles		Sediment retention pond		Site/Property Boundaries	
Check dams (One symbol per dam structure)		Silt fence		Contour lines	
Contour drains		Super silt fence		Vegetation to be retained	
Dirty Water Diversion Channel/Bund		Decanting earth bund		Vegetation to be removed	
Clean Water Diversion Channel/Bund		Flocculation shed		Trade Activity Zones	
Pipe drop or flume structure		Dewatering device/system		Project Stages	
Surface roughening		Stormwater inlet protection		Earth bund	
Benched slopes		Stormwater inlet/sump		Level spreader	
Stabilised entranceway		Contributing catchments		Outlet protection	
Topsoil and grassing - Temporary		No-go or buffer areas		Temporary watercourse crossing	
Topsoil and grassing - Permanent		Cut and Fill areas		Temporary watercourse diversion	
Revegetation (trees, shrubs & ground covers)		Secondary flood flow path		Temporary watercourse dam and pump (or dam and pipe)	
Hydroseeding		Watercourses			
Mulching		Overland flow paths			

Use as many symbols as necessary to clearly communicate the erosion and sediment control methods and devices. However, keep maps as simple as possible, using multiple maps where necessary to clearly convey aspects such as staging or temporary and permanent stabilisation practices.

Symbols for features not provided in the following table can be used on ESCPs if they are clearly identified in the map legend. Should be clear and legible in both B&W and colour print on Plans.

### 13.3 Accidental Discovery Protocol - Land Disturbance for Construction Sites / Building Sites

There is a high risk of disturbance and accidental discovery of Māori cultural material in the Nelson/ Tasman region resulting from earthworks and/or erosion. Cultural material includes: taonga (Māori artefacts), kōiwi (human bone) or wāhi tapu (places sacred to Māori of traditional, spiritual, or cultural significance). Many potential permitted activity construction/ land disturbance activities will be in areas that are not identified cultural precincts or discovery 'hotspot' areas. Iwi/Māori generally do not support activities that require earthworks – due to the threat to, and risk of damage of, both taonga and wāhi tapu sites.

Where there is an archaeological authority granted by Heritage New Zealand Pouhere Taonga to modify or destroy a cultural site, any finds uncovered are to be recorded and a report provided to mana whenua given to iwi/Māori.

In the event of an accidental discovery, the following protocols will be implemented. These protocols aim to mitigate any damage to and/or fossicking of wāhi tapu, taonga and kōiwi. It is important that adequate measures are taken to protect the area and cultural material.

#### **Taonga/Māori treasures Discovery Protocol Explanation [refer to flow chart 13.3.1]**

Taonga or 'ngā taonga tuku iho' (gifts handed down from the ancestors) are recognised, but not exclusive to, physical tangible heritage places that can be described as those land-based places created, formed or shaped by earlier inhabitants or tūpuna<sup>1</sup>. These are cultural sites, such as urupā (burials), pā, hangi pits, terraces, oven stones, middens, stone/rock structures, rock art, waka, house sites, pounamu (greenstone), modified soils, gardens, pakohe (argillite), fishing nets, sinkers, toki (artefacts), tools, weapons, Māori built heritage places such as marae buildings, whareniui (carved meeting house), pataka (food storage house), whare (house), post holes from remnant whare, occupation sites, carvings, artworks, and other structures such as waharoa (gateways) and various other taonga.

Taonga also reflects natural heritage sites such as natural features, with traditional activities (e.g. springs, trees, wetlands, caves) or a hapū and iwi landmark (e.g. mountain, river, lands, sea/lake, village, taonga species, pā harakeke (flax harvesting area) where no human activity is evident.

Taonga also includes intangible heritage, places where no visible feature or evidence is present but where a significant event or traditional activity may have occurred such as a battlefield, waka landing sites, places of meeting, of learning, of ritual, fishing grounds, taniwha den to name a few.

Various traditional activities have taken place across the region. There is evidence of occupation (pā and village sites), warfare, burials, marakai (gardens), large māhinga kai sites where natural resources and kai species were harvested, and other taonga have been found.

The diagrams on the following pages outline the processes to follow in the event of a taonga discovery (refer to **13.3.1** process flow chart) and for kōiwi tangata discovery (refer to **13.3.2** process flow chart) in the Nelson/Tasman region.

Note that, under the Protected Objects Act<sup>2</sup>, all taonga tūturu are in the first instance (prima facie) Crown owned, to allow claims for ownership to be heard by the Māori Land Court.

---

<sup>1</sup>Heritage New Zealand - Pouhere Taonga website, retrieved from: <http://www.heritage.org.nz/protecting-heritage/maori-heritage>.

<sup>2</sup> Protected Objects Act: <http://www.mch.govt.nz/nz-identity-heritage/protected-objects/taongatuturu>

**13.3.1 Process for follow for any Taonga site find**

**To be confirmed - process will be in place at the end of August**

13.3.2 Process when there is a discovery of kōiwi tāngata/human remains.

**To be confirmed DRAFT process will be in place at the end of August**

## 13.4 Ten Commandments of Erosion and Sediment Control

### 1) **Minimise Disturbance - Fit land development to land sensitivity.**

Land development should be fitted to land sensitivity and where possible, disturbance should avoid steeper slopes and other features such as streams and wetlands.

For any development, the total area of earthworks should be the minimum necessary to achieve the design outcome (including temporary works). The area of earthworks exposed to erosion at any given time should also be minimised through staging and progressive stabilisation.

### 2) **Stage Construction**

Carrying out bulk earthworks over the whole site maximises the time and area of soil that is exposed and prone to erosion. "Construction staging", where the site has earthworks undertaken in small units over time with progressive revegetation, limits erosion.

Careful planning is needed. Temporary stockpiles, access and utility service installation all need to be planned. Construction staging differs from sequencing. Sequencing sets out the order of construction to contractors.

### 3) **Protect Steep Slopes**

If slopes are worked and require stabilisation, simple vegetative covers such as topsoiling and seeding may not be immediately effective and additional measures may be required. Disturbance of existing slopes should be avoided wherever possible, particularly steep slopes which have a higher risk of erosion. To minimise erosion, clean water runoff from above the site must be diverted away from the exposed slopes.

### 4) **Protect receiving environments**

Receiving environments including sensitive receiving environments, existing streams, watercourses and proposed drainage patterns need to be mapped. Earthworks and the removal of vegetation beside or within streams (including intermittent streams), wetlands and the coast, may require consents from Nelson City Council or Tasman District Council. Councils should be consulted on these matters prior to finalising project designs.

All receiving environments, limits of disturbance and protection measures should be mapped on the ESC Plan. In addition, all practices to be used to protect new drainage channels should be marked, as well as crossings, disturbances and associated construction methods.

### 5) **Stabilise Exposed Areas Rapidly**

Disturbed soils should be progressively stabilised with vegetation, mulch, grassing or other stabilising methods after each earthworks stage and at specific milestones within stages.

### 6) **Install Perimeter Controls**

Perimeter controls above the site keep clean runoff out of the worked area - a critical factor for effective erosion control. Perimeter controls can also retain or direct sediment laden runoff within the site. Common perimeter controls are diversion drains, silt fences and earth bunds.

Detail the type and extent of perimeter controls in the E&SCP along with design parameters.

### 7) **Employ Detention Devices**

Even with the best erosion and sediment practices, earthworks will discharge sediment-laden runoff during storms. Along with erosion control measures, sediment retention structures are needed to capture runoff so sediment generated can settle out. The presence of fine grained soils means sediment retention ponds are often not highly effective. Ensure the other control measures used are appropriate for the project and adequately protect the receiving environment.



The fine-grained nature of Moutere Clays and other local soils means sediment retention ponds will usually require flocculant treatment (flocculation) to maximise their efficiency. Include sediment retention structure design specifications, detailed inspection and maintenance schedules of structures in the E&SCP.

**8) Get trained and develop experience**

As contractors are generally responsible for installing and maintaining ESC practices, a trained and experienced contractor is an important element of an ESC Plan. Trained and experienced staff can save projects time and money through proactive construction and maintenance of ESCs. Staff should be encouraged to become experienced in ESC. Key staff should also be assigned to provide that role, so that the appropriate level of experience and supervision is available for each new project.

**9) Adjust the ESC Plan as needed**

An effective E&SCP is modified as the project progresses from bulk earthworks to project completion. Factors such as weather, changes to grade and altered drainage can all mean changes to planned erosion and sediment control practices. Update the E&SCP to suit site adjustments in time for the pre-construction meeting and initial inspection of installed erosion and sediment controls, and make sure it is regularly referred to and available on site.

**Note: For sites with resource consents, adjustments to the ESC Plan may require sign-off from relevant Council.**

**10) Assess and Adjust Inspect, monitor and maintain control measures.**

ESC measures need to be inspected, monitored and maintained.

Inspection and maintenance of controls is especially important prior to and following a storm event. A large or intense storm can leave ESC measures in need of repair, replacement, reinforcement or cleaning out. Maintaining and repairing measures as soon as possible after a storm event will maximise the ongoing efficiency of the measures and minimise adverse environmental effects.

### 13.5 Slope Conversion and Terminology

Ideally any slopes shown on the plans should be provided in percentage, ratio and degrees as given in the conversion table below.

Table 13-2 Slope conversion table (percent-ratio-degrees)

Percent	Grade/Ratio (h:1v)	Degrees
2.00%	50.00	1.15
3.00%	33.33	1.72
4.00%	25.00	2.29
5.00%	20.00	2.86
7.00%	14.29	4
8.33%	12.00	4.76
8.75%	11.43	5
10.00%	10.00	5.71
12.00%	8.33	6.84
15.00%	6.67	8.53
15.15%	6.60	8.62
17.63%	5.67	10
20.00%	5.00	11.31
25.00%	4.00	14.04
26.79%	3.73	15
30.00%	3.33	16.7
32.00%	3.13	17.74
33.00%	3.03	18.26
36.36%	2.75	19.98
36.40%	2.75	20
40.00%	2.50	21.8
46.63%	2.14	25
50.00%	2.00	26.57
58.00%	1.72	30
70.00%	1.43	35
84.00%	1.19	40
100.00%	1.00	45

### 13.6 Universal Soil Loss Equation Information

The USLE is a simple model originally developed for agricultural practices in the USA. It is a suitable sediment yield estimation tool for activities such as earth working operations.

Rather than providing an accurate estimate of actual total sediment yield the most beneficial use of the USLE is to help identify variations of potential sediment yields across a particular site. It is critical that a site is divided up into logical sectors based on gradient, slope length and surface cover. Other factors are the proximity and nature of the receiving environment. Once completed the USLE will then allow the erosion and sediment control methodology to be tailored to suit the site's variations.

While the overall estimate of yield is indicative of the magnitude of sediment likely to be discharged, the range of assumptions required in the USLE calculation means that it should not be relied on as an accurate assessment of actual total yield.

The USLE is represented by the following equation which provides an estimate of sediment generation (A) in tonnes/ha/yr for a given site:

$$A = R * K * (LS) * C * P$$

Where:

- A = sediment generation (tonnes/hectare/year)
- R = rainfall erosion index (J/hectare)
- K = soil erodibility factor (tonnes/unit of R)
- LS = slope length and steepness factor (dimensionless)
- C = ground cover factor (dimensionless)
- P = roughness factor (dimensionless)

Once the estimate of sediment generation (A) has been determined, the sediment yield from a specific site is estimated by the following equation:

$$\text{Site Net Sediment Yield Calculation} = A * Sa * SDR * SCE * D$$

Where:

- A = the Sediment generation calculated from the USLE
- Sa = the area of bare soil in hectares
- SDR= Sediment Delivery Ratio (how much sediment makes it to the control devices)
- SCE= Sediment Control Efficiency (how much sediment passes through control devices)
- D = the duration of the works – how long the soil is exposed for.

#### 13.6.1 Rainfall Erosion Index (R in J/hectare)

R is calculated by the formula  $R = 0.00828 * P^{2.2 * 1.7}$

Where p is the total rainfall (in mm) for the 6-hour duration two-year storm event for the subject site. The value of P can be derived from the HIRDS website (refer 13.7.11). The multiplier of 1.7 converts the R value from imperial to metric units.

### 13.6.2 Soil Erodibility Factor (K in tonnes/unit of R)

To calculate K, the percentage of sand, silt and clay should be known for each dominant soil type within a site. For the purposes of calculation, the soil type is usually taken as being uniform across the site however, this is not always the case and soil analysis should be undertaken to determine if significant variations occur within the site.

Once the soil type is known, K is calculated as follows:

$$K = (kn+kc)*1.32$$

Where kn is the value taken from the nomograph and kc is the correction factor from the table below). Multiplying by 1.32 gives the value in metric units.

**Step 1.** Using **Error! Reference source not found.** below, estimate the K value for the basic soil type from the nomograph. The example shown in the nomograph is based on a soil with 40% sand, 40% clay and 20% silt.

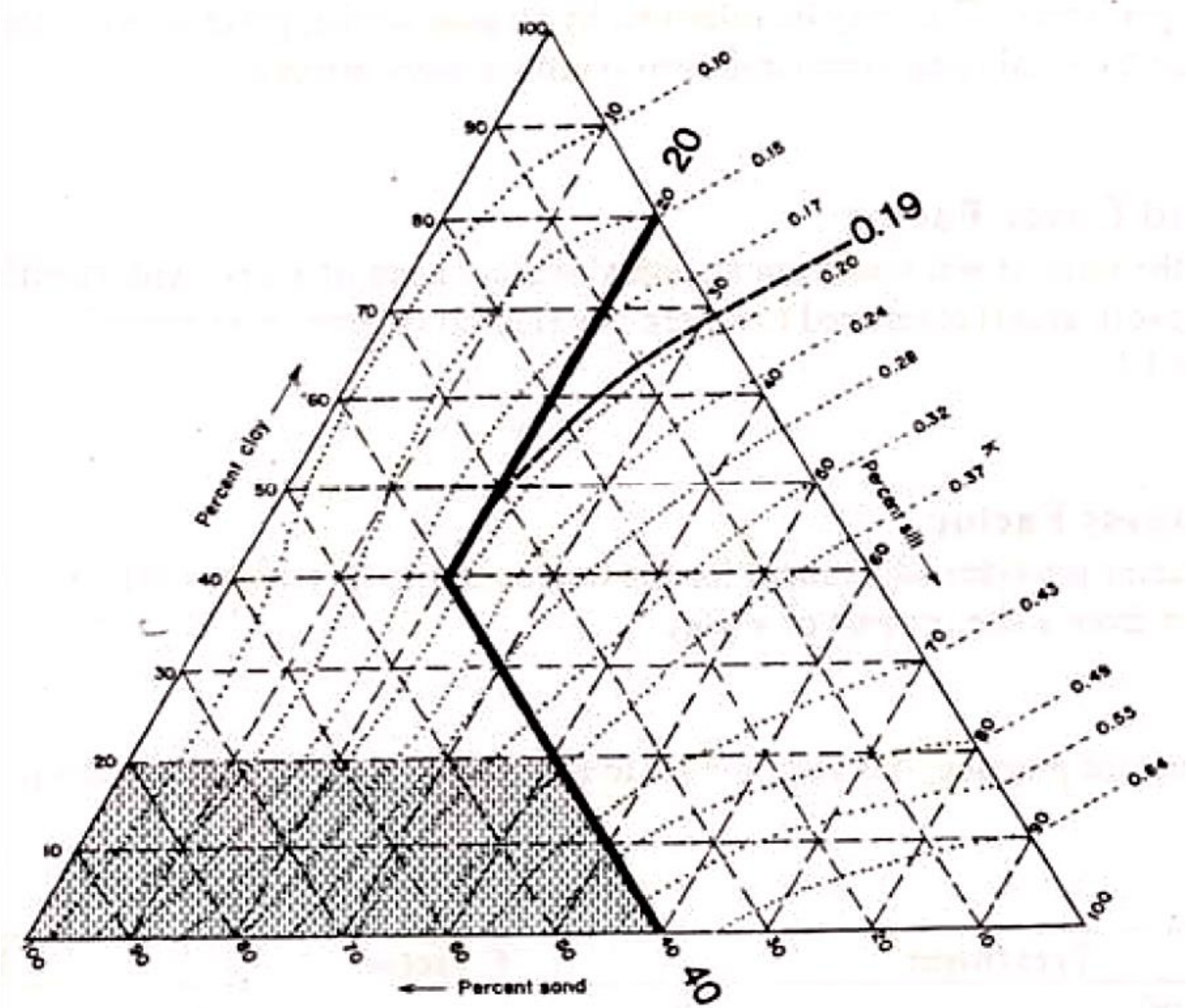

Figure 13-1 Nomograph for Estimating K Values  
silt.

Table 13-3 K Value Correction Factor

K Value	Correction factor when percent organic matter is:				
	0% (exposed clay)	1%	2%	3%	4% (topsoil)
More than 0.4	+0.14	+0.07	0	-0.07	-0.14
0.2-0.4	+0.10	+0.05	0	-0.05	-0.10
Less than 0.2	+0.06	+0.03	0	-0.03	-0.06

**Step 2.** Correct for organic content using



Table 13-3 (the nomograph assumes 2% organic matter). In this table exposed clay is considered 0% organic, topsoil 4% organic. In the example shown on the nomograph, for an exposed site, the value (0.19) would be corrected by 0.06 (exposed clay) giving a K value of 0.25.

**Step 3.** Multiply the corrected K Value by 1.32 to convert from imperial to metric. The above example would give a resulting K value of 0.33.

### **13.6.3 Slope Length and Steepness Factor (LS - dimensionless)**

To determine the LS factor, the slope length and slope gradient for the area of the site being assessed is required. Using these parameters, the LS factor for a particular slope is read from Table 13-4. In developing the USLE methodology, a standardised slope was used to determine soil loss. The LS factor derived from the table provides correction for variation in the actual slope gradient and length compared to the standardised slope.

It should be noted that the potential sediment generation on a site increases with an increase in both slope angle and slope length. Thus, it is essential that bare area, slope length and where possible slope angle are minimised (refer Chapter 6).

Table 13-4 for Determining Slope Length and Steepness Factor (LS)

Slope Ratio s,%	Slope Length, m												
	10.00	25.00	50.00	75.00	100.00	125.00	150.00	175.00	200.00	225.00	250.00	275.00	300.00
0.50	0.08	0.09	0.11	0.11	0.12	0.13	0.13	0.14	0.14	0.14	0.15	0.15	0.15
1.00	0.09	0.12	0.15	0.17	0.18	0.20	0.21	0.22	0.23	0.23	0.24	0.25	0.26
2.00	0.14	0.19	0.23	0.26	0.29	0.31	0.32	0.34	0.35	0.37	0.38	0.39	0.40
3.00	0.21	0.27	0.33	0.38	0.41	0.44	0.46	0.48	0.50	0.52	0.54	0.56	0.57
4.00	0.26	0.37	0.49	0.57	0.64	0.70	0.76	0.80	0.85	0.89	0.93	0.96	1.00
5.00	0.31	0.48	0.69	0.84	0.97	1.08	1.19	1.28	1.37	1.45	1.53	1.61	1.68
6.00	0.39	0.61	0.86	1.06	1.22	1.36	1.49	1.61	1.72	1.83	1.93	2.02	2.11
7.00	0.47	0.75	1.06	1.29	1.49	1.67	1.83	1.98	2.11	2.24	2.36	2.48	2.59
8.00	0.57	0.90	1.27	1.56	1.80	2.01	2.20	2.38	2.54	2.70	2.84	2.98	3.11
9.00	0.67	1.06	1.50	1.84	2.13	2.38	2.60	2.81	3.01	3.19	3.36	3.53	3.68
10.00	0.78	1.24	1.75	2.15	2.48	2.77	3.04	3.28	3.51	3.72	3.92	4.11	4.30
11.00	0.91	1.43	2.02	2.48	2.86	3.20	3.51	3.79	4.05	4.29	4.53	4.75	4.96
12.50	1.10	1.74	2.46	3.02	3.48	3.89	4.26	4.61	4.92	5.22	5.51	5.77	6.03
15.00	1.47	2.32	3.28	4.02	4.64	5.19	5.68	6.14	6.56	6.96	7.34	7.69	8.04
16.70	1.74	2.76	3.90	4.77	5.51	6.16	6.75	7.29	7.79	8.27	8.71	9.14	9.55
20.00	2.34	3.70	5.23	6.40	7.39	8.26	9.05	9.78	10.45	11.09	11.69	12.26	12.80
22.00	2.73	4.32	6.11	7.49	8.65	9.67	10.59	11.44	12.23	12.97	13.67	14.34	14.98
25.00	3.38	5.34	7.55	9.25	10.68	11.94	13.08	14.12	15.10	16.01	16.88	17.70	18.49
30.00	4.56	7.21	10.19	12.48	14.41	16.12	17.65	19.07	20.39	21.62	22.79	23.90	24.97
33.30	5.41	8.55	12.09	14.80	17.09	19.11	20.93	22.61	24.17	25.64	27.03	28.34	29.61
35.00	5.86	9.26	13.10	16.05	18.53	20.71	22.69	24.51	26.20	27.79	29.30	30.73	32.09
40.00	7.25	11.47	16.22	19.86	22.93	25.64	28.09	30.34	32.43	34.40	36.26	38.03	39.72
45.00	8.71	13.78	19.48	23.86	27.55	30.80	33.74	36.45	38.96	41.33	43.56	45.69	47.72
50.00	10.22	16.15	22.84	27.98	32.31	36.12	39.57	42.74	45.69	48.46	51.08	53.57	55.95
55.00	11.74	18.56	26.25	32.15	37.13	41.51	45.47	49.12	52.51	55.69	58.71	61.57	64.31
57.00	12.35	19.53	27.62	33.83	39.06	43.67	47.84	51.68	55.24	58.60	61.77	64.78	67.66
60.00	13.27	20.98	29.67	36.34	41.96	46.91	51.39	55.51	59.34	62.94	66.35	69.59	72.68
66.70	15.29	24.18	34.20	41.88	48.36	54.07	59.23	63.98	68.40	72.55	76.47	80.20	83.77
70.00	16.27	25.73	36.39	44.57	51.46	57.53	63.03	68.08	72.78	77.19	81.37	85.34	89.13
75.00	17.72	28.03	39.63	48.54	56.05	62.67	68.65	74.15	79.27	84.08	88.62	92.95	97.08
80.00	19.13	30.25	42.78	52.39	60.50	67.64	74.10	80.03	85.56	90.75	95.66	100.33	104.79
85.00	20.49	32.39	45.81	56.11	64.78	72.43	79.34	85.70	91.62	97.18	102.43	107.43	112.21
90.00	21.79	34.45	48.72	59.67	68.90	77.03	84.38	91.14	97.43	103.35	108.94	114.25	119.33
95.00	23.03	36.41	51.50	63.07	72.83	81.42	89.19	96.34	102.99	109.24	115.15	120.77	126.14
100.00	24.21	38.28	54.14	66.31	76.57	85.61	93.78	101.29	108.29	114.85	121.07	126.98	132.62

Calculated From:

$$LS = \left( \frac{65.41 \times s^2}{s^2 + 10,000} + \frac{4.56 \times s}{\sqrt{s^2 + 10,000}} + 0.065 \right) \times \left( \frac{l}{72.5} \right)^m$$

LS= topographic factor  
 l = Slope length, m  
 s = Slope steepness  
 m = Exponent dependent on slope steepness  
 0.2 for slopes < 1%, 0.3 for slopes 1-3%, 0.4 for slopes 3.5-4.5%, and 0.5 for slopes > 5%

### 13.6.4 Ground Cover Factor (C) and Roughness Factor (P)

The Ground Cover Factor (C) is the ratio of soil loss from an actual site (or parts of a site) with specific ground cover (e.g. clay, topsoil, grass) compared to a bare site (i.e. no vegetation or topsoil). A bare site is given a C value of 1.0.

The P factor provides adjustment for the degree to which surface roughness affects the erosion of sediment from a site (or part of a site).

As a standard practice, it is appropriate to use the range of C and P values given in Table 13-5.

Table 13-5 USLE C and P Factors

Treatment	C Factor	P Factor
Bare soil - Compacted and smooth	1.0	1.32
Bare soil - Track walked on contour	1.0	1.2
Bare soil - Rough irregular surface	1.0	0.9
Bare soil - Disked to 250mm depth	1.0	0.8
Native vegetation (undisturbed)	0.01	1.0
Pasture (undisturbed)	0.02	1.0
Establishing grass	0.10	1.0
Mulch – on subsoil	0.15 (3mth period only)	1.0
Mulch – on topsoil	0.05 (3mth period only)	1.0

### 13.6.5 Estimating Sediment Yield

Once the value for sediment generation potential (A - in tonnes/ha/yr) is calculated the quantity of sediment likely to be discharged to the receiving environment (sediment yield) can be determined by including the site area, sediment delivery ratio, sediment control efficiency and duration of the works. The USLE and associated sediment yield should always be carried out for each part of a site where slope, soil type or surface cover varies.

### 13.6.6 Area of Exposed Soil (Sa in hectares)

To derive an estimate of sediment yield from a particular site, or part of a site, the actual area (in hectares) of exposed ground should be taken into account.

### 13.6.7 Sediment Delivery Ratio (SDR, 0.0 – 1.0)

In general, some of the sediment that is initially eroded within a site will not be transported to the sediment control measures. This sediment will be retained within depressions, rough surfaces and vegetation. The Sediment Delivery Ratio takes this into account.

The value used for the sediment delivery ratio has a big impact on the estimated yield, however accurate assessment is difficult and dependent on several site variables. As the sediment yield calculation given in this guideline is to be used primarily for comparison purposes in development of Erosion and Sediment Control Plans it is considered that the sediment delivery ratios in the following table are sufficient. Use of other values should be accompanied by an explanation and more conservative values should be considered for particularly steep sites and small drainage areas.

Table 13-6 Sediment Delivery Ratios

Sediment Delivery Ratio	Slopes up to 10% (10:1, 5.71°)	Slopes greater than 10% (10:1, 5.71°) or close to waterways
	0.5	0.7

### 13.6.8 Sediment Control Efficiency (SCE in %)

Sediment control efficiency is a measure of how much sediment makes it through the sediment control device and into receiving environments. For coarse grained soils or with the use of chemical flocculation, the efficiency may be high, while for fine grained soils (eg high clay content) or where device designs are not ideal, efficiencies may be lower.

Values given in the table below have been collated from various research into control efficiencies (refer Chapter 6, section 6.2.7.1). Use of other values should be accompanied by explanation or references.

The value of SCE is determined by **SCE = (100% - control efficiency %)** as we need to include how much sediment makes it past the control device, rather than how much is retained.

Table 13-7 Sediment Control Efficiencies

Control type	Control Efficiency without flocculation	Control Efficiency with flocculation
Sediment Ponds	0.5 -0.8	0.75 -0.95
Decanting Earth Bunds	0.60	0.8 <sup>A</sup>
Silt fence and super silt fence	0.4-0.75	na

*Estimated from relative average efficiencies for ponds with and without flocculation*

### 13.6.9 Duration of Exposure (D in years)

The USLE provides an estimate of average annual soil loss. As most sites will only be exposed for part of the year, the duration of the works should be taken into account.

### 13.6.10 USLE and Sediment Yield - Example Calculation

In the following example, based in Takaka (NZTM E1583666, N5477378), the site is to be worked for four months, the site soil type is 32% clay, 20% sand and 48% silt. The total rainfall (from HIRDS) for the 6hr 2year event at this location is 77.6mm. It is assumed that the sediment control efficiency will be 25% (ie. 75% removal). There are the following areas, slope lengths and slope angles for three differing parts of the site:

- Area A: 3.3ha and 150m slope length, 5% slope
- Area B: 5.0ha and 200m slope length, 10% slope
- Area C: 1.0ha and 100m slope length, 20% slope

$$A = R * K * (LS) * C * P$$

$$R = 0.0082 * (77.6^{2.2}) * 1.7 = 202.4$$

$$K = 0.37(\text{from nomograph}) + 0.1 (\text{bare clay correction factor}) * 1.32 (\text{converts to metric}) = 0.62$$

LS: (from table) Area A=1.19, Area B=3.51, Area C=7.39

C (from table) = 1.0 (compacted bare soil)

P (from table) = 1.32 (compacted bare soil)

Table 13-8 Example USLE Calculation Summary

Section of site	USLE					Sediment Generation (A) (tonnes/ha/yr)	Sa Site Area (ha)	SDR Sediment Delivery Ratio	SCE Sediment Control Efficiency (%)	D Duration (yrs)	Net Sediment Yield (tonnes)
	R	K	LS	C	P						
A	202.4	0.62	1.19	1.0	1.32	197	3.3	0.5	25	0.33	27
B	202.4	0.62	3.51	1.0	1.32	581	5.0	0.7	25	0.33	168
C	202.4	0.62	7.39	1.0	1.32	1224	1.0	0.7	25	0.33	71
<b>Total</b>						<b>2003</b>	<b>9.3</b>				<b>265</b>

## 13.7 Design of Erosion and Sediment Controls

### 13.7.1 Introduction

Erosion and sediment control practice performance and relative effectiveness depends on appropriate hydrological design of the controls. Hydrological design is based on the following parameters:

- Soil
- Slope
- Ground cover
- Rainfall
- Size of contributing catchments
- Risk associated with the design (including receiving environment sensitivity and duration of works).

There are three issues to consider in sizing storage practices:

1. Storage volume for sediment retention performance, and
2. Design discharge rate to ensure that downstream stream channel erosion is not increased during construction (water quantity attenuation).
3. Secondary overflow management.

### 13.7.2 Storage Volume Sizing for Sediment Control Performance

The volumes of storage can be calculated by using the rational formula and calculating a volume by using a trapezoidal hydrograph approach.

Firstly the peak discharge (Q) is calculated:

$$Q=0.00278CiA$$

Where:

Q =	Peak discharge (m <sup>3</sup> /s)	
C =	Runoff coefficient (unit less)	Determined from Table 13-11 (refer section 13.7.4)
i =	Rainfall (mm/hr)	Determined using the most recent NIWA HIRDS data or local data for a 1 hour duration storm with the appropriate storm probability selected from Table 13-12 (refer section 13.7.8)
A =	Catchment area (ha)	Contributing catchment from site measurements (refer section 13.7.3)

*(note: multiplying by 0.00278 converts results to metric and units to m<sup>3</sup>/s)*

Once Q is calculated the volume of the storage practice (V) can be calculated:

$$V = QD$$

Where:

V =	Volume of storage practice (m <sup>3</sup> )	
Q =	Peak discharge (m <sup>3</sup> /s)	Determined from the previous calculation
D =	Storm duration (sec.)	With D = 3600 seconds for a 1-hour storm.

The volume calculated is then used to size the storage system.



If a lesser volume is proposed by the Designer, a detailed soil particle analysis should be provided when approval is sought.

Identification of values for Catchment Area (A), Runoff Coefficient (C), and Rainfall Intensity (i) are outlined in the following sections.

### **13.7.3 Contributing Catchment Area (A)**

The area value (A) to be included in the rationale formula includes the entire catchment that contributes flow to the device being sized. This includes both disturbed and undisturbed areas, but excludes any areas diverted away from the device, for example up catchment clean water diverted around the works.

In order to keep device sizes to a minimum it is important to reduce the contributing catchments areas as much as practicable by:

1. Minimising the area of land disturbed (retaining existing ground cover), and
2. Utilising up catchment clean water diversion drains (refer Chapter 6, section 6.2) to redirect water around disturbed areas
3. Utilizing sub catchment dirty water diversion drains to direct dirty water to additional treatment devices

Using these methods will minimise the volume of dirty water requiring treatment at each device.

Once the extent of the contributing catchment has been identified, it is important to identify sub-catchments within this that may have differing soils, slopes and ground cover. These aspects are used to identify the appropriate Runoff Coefficient (C) value to use in the design calculations. Selection of an appropriate Runoff Coefficient (C) is covered below in Section 13.7.7.

### **13.7.4 Runoff Coefficient (C)**

Determination of the appropriate runoff coefficient is dependent on slope, soil type, and ground cover.

#### **13.7.4.1 Slope**

Increases in slope increase site discharge and velocity of runoff. In fact, with all other factors remaining equal, slope has the most influence on the generation of sediment (if the slope angle is doubled, three times the sediment is generated and if slope length is doubled 1.5 times the sediment is generated).

The slope gradient for use in determining the runoff coefficient is determined by the slope immediately above the device being sized, or by the average slope angle over the contributing catchment, whichever is greater.

For practicality slopes of interest are divided into three categories: less than 10 %; between 10% and 20%; and greater than 20%.

Table 13-9 Slope conversion table (percent, ratio and degrees)

Slope %	As Slope ratio (h:v)	In degrees
10%	10:1	5.71
20%	5:1	11.31

It is important to realise that the human eye invariably distorts slopes by exaggerating them. People will often judge a 1:3 slope to be a 1:1 slope. Similarly, a slope of 15° will often be estimated to be close to 45°. Ensure measurements (eg using contour maps) are use when determining the appropriate slope on your site.

Slope is included in the selection of a Runoff Coefficient (C) value through the use of the slope correction factors in Table 13-11 (refer section 13.7.4).

### 13.7.5 Soil Type

Soils have variable permeability rates and sizing of control practices will be based on the amount of water that runs over the soil rather than what goes into it.

The Tasman District has a wide variety of soils, however for the purposes of determining an appropriate runoff coefficient factor (C) to use in the design calculation, we are concerned primarily with the clay, silt and sand/gravel components and the subsequent level of soakage (refer Table 13-10)

Due to the highly variable nature of soils, every project should have a soils analysis done to determine the appropriate runoff coefficient(s) and identify whether flocculation is required. Consideration also needs to be made of not just the surface soil, but all soil horizons that may be disturbed, for example a sandy loam topsoil can have a clay loam subsoil.

Table 13-10 Soil Types

Soil Type	Soil particle characteristics (average%)			Soakage
	clay	silt	sand	
Clay	60%	20%	20%	Low
Clay loam	35%	30%	35%	Low
Silt loam	23%	40%	37%	Medium
Sandy Loam	15%	15%	70%	High
Sands and Gravels	5%	5%	90% (sand or gravel)	High

*Note: Soil type relates to the soil horizon being exposed (a sandy loam topsoil can have a clay loam subsoil)*

Soils are also significantly altered during site development including:

- stripping off the topsoil
- compaction
- removing large amounts of native soils in cut operations
- bringing in large amounts of new material if fill is needed
- erosion of surface soils.

This will affect the amount of site runoff for different construction stages. Where compaction occurs, the effect is a significant reduction in water infiltration into the ground. This applies across the board to all soils, but to a lesser extent for sands and gravels.

It is important to do the following when planning erosion and sediment control practices:

- Determine what the soils are on site – including all soil horizons to be disturbed, and determining the clay content.
- Determine whether soil characteristics will be changed by the earthworks;
  - If fill material is brought on site, what changes will that material make to the existing soil?
  - How much cut and fill will be done on site and how will the soil profile be changed?

Selection of the appropriate soil type for determining the Runoff Coefficient should include consideration of all soil types that will be affected by land disturbance and the variability of soil types across the area of the contributing catchment, either due to natural variability or to land disturbance activities.

### **13.7.6 Ground Cover**

Relevant ground covers are listed in Table 13-11 and cover bare areas, vegetated areas and developed areas with surfaces of varying permeability.

Where possible clean water from undisturbed areas of the contributing catchment should be diverted away from treatment devices, thereby reducing the volume of water to be treated and minimising the required device size.

Determination of the area to be disturbed should be precautionary. If there is any uncertainty as to the extent of earthworks required, a larger proportion of the contributing catchment should be calculated using the bare soil C values from Table 13-11. Underestimating the area of disturbed land could result in devices being undersized, requiring their redesign and/or rebuild resulting in costly work stoppages.

### **13.7.7 Selection of Runoff Coefficient (C)**

Table 13-11 provides runoff coefficient values for different soil types and ground cover with correction factors for different slopes.

For contributing catchments with more than one type of soil, slope or cover two approaches to C factor selection, and subsequent volume calculation, are acceptable:

- Use the highest C factor identified in the sub catchments as the C value for the whole contributing catchment, or
- Calculate the volume for each sub catchment separately, using the C values appropriate to each sub-catchments soil type, slope and ground cover and sum the volumes to find the total volume for the device.

Table 13-11 Representative C (runoff coefficients) values for different soil types and slope

Natural Surface Types		C	Developed Surface Types		C
<b>Low soakage soil types:</b>			Fully roofed and/or sealed developments		0.90
– bare uncultivated soil		0.70	Steel and non-absorbent roof surfaces		0.90
– pasture and grass cover		0.40	Asphalt and concrete paved surfaces		0.85
– bush and scrub cover		0.35	Near flat and slightly absorbent roof surfaces		0.80
– cultivated		0.30	Stone, brick and pre-cast concrete paving panels:		
<b>Medium soakage soil types:</b>			– with sealed joints		0.80
– bare uncultivated soil		0.60	– with open joints		0.60
– pasture and grass cover		0.30	Unsealed roads		0.50
– bush and scrub cover		0.25	Unsealed yards and similar surfaces		0.35
– cultivated		0.20	<b>Slope Correction Factor</b>		
<b>High soakage soil types:</b>			<b>Slope</b>	<b>Adjustment Factor</b>	
– bare uncultivated soil		0.50	<5%	subtracting 0.05	
– pasture and grass cover		0.20	5-10%	no adjustment	
– bush and scrub cover		0.15	10-20%	adding 0.05	
– cultivated		0.10	20% or steeper	adding 0.10	

(Based on: Compliance Document for New Zealand Building Code Clause E1 Surface Water 2011. The coefficients in this table assume saturated ground conditions from previous rain).

### 13.7.8 Rainfall Intensity (i)

Rainfall around the district is variable and having a sizing criterion based on one area alone is not suitable for the whole district.

Rainfall intensities for appropriate storm sizes can be obtained through the online NIWA High Intensity Rainfall Design System (HIRDS) (refer section 13.7.11).

### 13.7.9 Storm size selection

The storm duration used in this guideline is for a 1-hour duration storm. The one-hour storm was chosen as providing reasonable sizing requirements if the duration of the storm is provided in seconds. Longer times provide significantly larger volumes and the storage requirements become unreasonable.

The storm probability which determines the size of the storm is selected from Table 13-12 which uses a risk based approach dependent on the sensitivity of receiving environments and duration of the works.

The sensitivity of receiving systems as prioritised in Chapter 4, section 4 are used in Table 13-12, in combination with the desired level of risk, to identify the frequency of storm to be used in the design calculations. If a site drains into more than one receiving systems, design of storage controls should be based on the more stringent criteria.

Table 13-12 Receiving environments and design storms

Category	Receiving system type	Potential for Adverse Effects from Erosion and Sedimentation	Desired design risk (chance of event occurring during works)		Storm frequency (Average Recurrence Interval) to design for (1-hour duration) (Years)				
			%	chance	Site disturbance Duration				
					up to two weeks	up to one mth	up to three mths	up to six mths	up to 12 mths
A	Estuaries	Highest	<2.5%	1 in 40	2 yr	5 yr	10 yr	20 yr	40 yr
A	Water Conservation Order Areas	Highest	<2.5%	1 in 40	2 yr	5 yr	10 yr	20 yr	40 yr
A	Spring fed streams	Highest	<2.5%	1 in 40	2 yr	5 yr	10 yr	20 yr	40 yr
B	Streams and Rivers	High	<5%	1 in 20	*85% of 2yr	2 yr	5 yr	10 yr	20 yr
B	Wetlands	High	<5%	1 in 20	*85% of 2yr	2 yr	5 yr	10 yr	20 yr
B	Karst	High	<5%	1 in 20	*85% of 2yr	2 yr	5 yr	10 yr	20 yr
B	Lakes	Moderate	<5%	1 in 20	*85% of 2yr	2 yr	5 yr	10 yr	20 yr
C	Open coast	Low	<10%	1 in 10	*85% of 2yr	*85% of 2yr	2 yr	5 yr	10 yr
C	Land	Low	<10%	1 in 10	*85% of 2yr	*85% of 2yr	2 yr	5 yr	10 yr

\* For practicality, 85% of the 2yr ARI is use as an approximation of the annual ARI event, as data for the 2yr ARI is readily available from the HIRDS website. For temporary culverts in watercourses that fall in this category, culvert size can be determined using 85% of the channel width at bank full.



For other durations the relevant storm frequency to achieve the desired risk level can be determined using the equation:

$$T = 1 - [(1 - P)^{1/n}]$$

Where **T** is the storm frequency (Annual Recurrence Interval in years),  
**P** is the desired risk level (ie 0.025, 0.05 or 0.1), and  
**n** is the duration of the works in years.

The potential effects of climate change on storm frequency does not need to be accounted for in the design of sediment and erosion controls, as it does with stormwater design, as land disturbance is of relative short duration.

### 13.7.10 Example calculation

#### 13.7.10.1 Sizing of storage practices

##### Steps

1. Determine site location and from that determine latitude and longitude.
2. Determine project duration.
3. Using latest HIRDS (from NIWA website) - or local data - select the 1-hour storm using the appropriate frequency storm from Table 13-12 to obtain the Rainfall Intensity (i) value.
4. Determine site soils, slope and ground cover to select the Runoff Coefficient C Factor.
5. Determine the site area in hectares that would drain to the storage practice (A).
6. Use the Rational Formula to calculate the peak discharge (Q).
7. Multiply the peak discharge (Q) by 3,600 seconds to get the volume of the sediment storage practice.

For example a project in Takaka, which drains to the Takaka River.

1. NZTM2000 Easting 1583666 Northing 5477378.
2. Site soils are bare melanic soils with moderate soakage having slopes <10% so the runoff coefficient 'C' factor is 0.65 (refer Table 13-11).
3. As the project duration is 12 months and the site drains to the Takaka River, sizing of the sediment retention pond should be on a 20-year, 1-hour storm (refer Table 13-12), which gives a rainfall intensity 'i' of 53.5 mm/h (from HIRDS as of 29-Oct-13).
4. Site area 'A' draining to the device is 1 hectare.
5.  $Q = 0.00278 * C * i * A$  which in this case:  $Q = 0.00278 * (0.65) * (53.5) * (1) = 0.097 \text{ m}^3/\text{s}$ .
6.  $V = Q * D$  (where D is 3600), so in this case: Storage volume =  $0.097 * (3600) = 350 \text{ m}^3$ .

### 13.7.11 HIRDS website

Use of the HIRDS website (<http://hirds.niwa.co.nz>) requires the following steps (refer Figure 13-2).

Find your site using the google map. Coordinates for the site selected (ie the approximate centre) should be recorded in NZTM (easting and northing) to be compatible with the Council GIS system

1. Enter an appropriate site name (eg physical address).
2. Leave the “Projected Temperature Changes” blank - climate change considerations are not required.
3. Set the “Output Table Format” to “Intensity-Duration-Frequency”.
4. Generate Tables.
5. Ensure rainfall intensity is taken from the correct duration (60m) and the appropriate storm ARI event (data is available for return intervals of 1.58, 2, 5, 10, 20, 30, 40, 50, 60, 80 and 100 years).

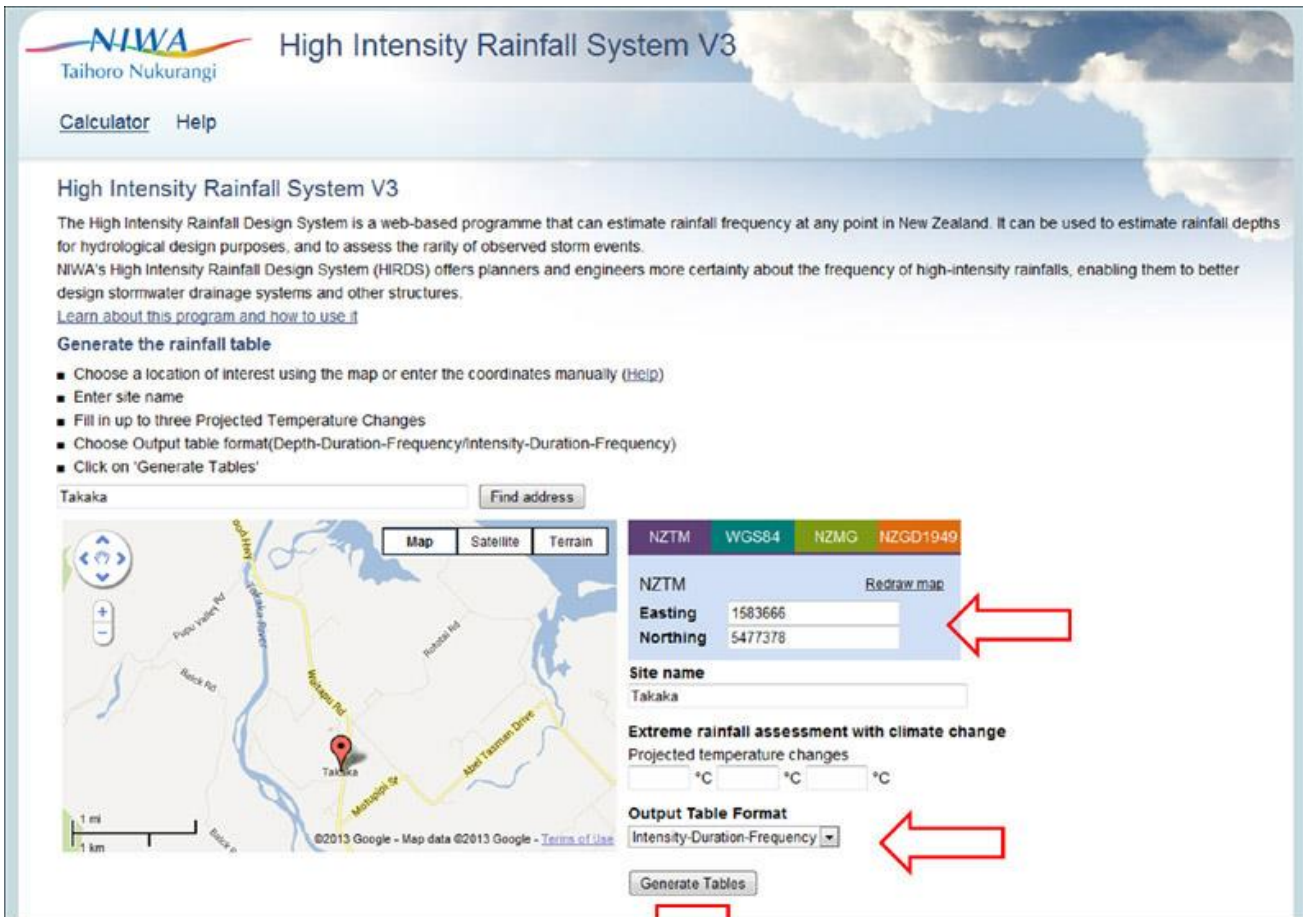
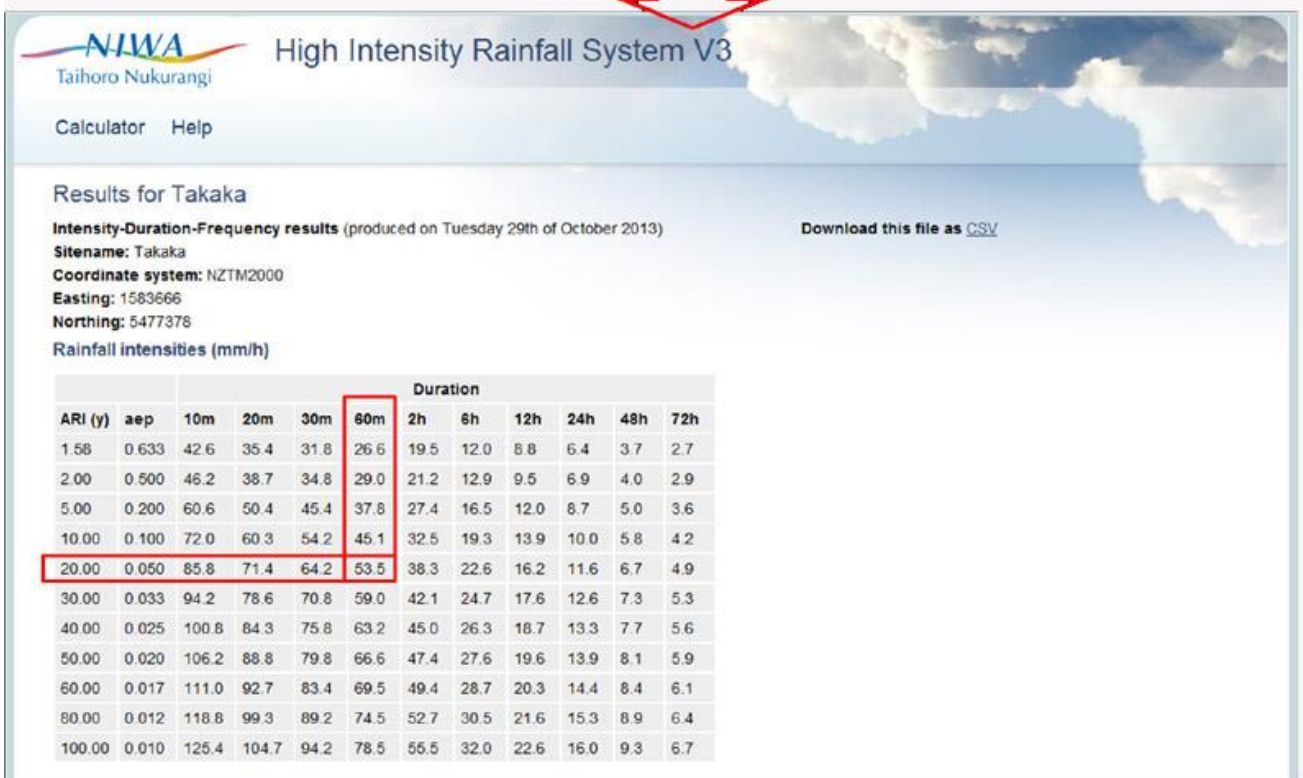
**Intensity-Duration-Frequency results** (produced on Tuesday 29th of October 2013) [Download this file as CSV](#)

**Site name:** Takaka  
**Coordinate system:** NZTM2000  
**Easting:** 1583666  
**Northing:** 5477378

**Rainfall intensities (mm/h)**

ARI (y)	aep	Duration									
		10m	20m	30m	60m	2h	6h	12h	24h	48h	72h
1.58	0.633	42.6	35.4	31.8	26.6	19.5	12.0	8.8	6.4	3.7	2.7
2.00	0.500	46.2	38.7	34.8	29.0	21.2	12.9	9.5	6.9	4.0	2.9
5.00	0.200	60.6	50.4	45.4	37.8	27.4	16.5	12.0	8.7	5.0	3.6
10.00	0.100	72.0	60.3	54.2	45.1	32.5	19.3	13.9	10.0	5.8	4.2
20.00	0.050	85.8	71.4	64.2	53.5	38.3	22.6	16.2	11.6	6.7	4.9
30.00	0.033	94.2	78.6	70.8	59.0	42.1	24.7	17.6	12.6	7.3	5.3
40.00	0.025	100.8	84.3	75.8	63.2	45.0	26.3	18.7	13.3	7.7	5.6
50.00	0.020	106.2	88.8	79.8	66.6	47.4	27.6	19.6	13.9	8.1	5.9
60.00	0.017	111.0	92.7	83.4	69.5	49.4	28.7	20.3	14.4	8.4	6.1
80.00	0.012	118.8	99.3	89.2	74.5	52.7	30.5	21.6	15.3	8.9	6.4
100.00	0.010	125.4	104.7	94.2	78.5	55.5	32.0	22.6	16.0	9.3	6.7

Figure 13-2 HIRDS Webpage Example

### 13.8 Tasman/Nelson region fish migration and spawning calendars

Source: Reproduced from: *State of the Environment Report: The Health of Freshwater Fish Communities in Tasman District. September 2011*. TDC Report #: 11001. James, T. and Kroos, T.

Fish migration calendar for the Tasman District showing the peak and range periods for migration activity, migration status and life stage at time of migration. Modified from Hamer 2004. Key: u/s=upstream, d/s=downstream, █ Peak █ Range

Species	Direction	Life stage	Summer			Autumn			Winter			Spring		
			Dec	Jan	Feb	Mar	Apr	May	Jun	Jul	Aug	Sep	Oct	Nov
Lamprey <sup>25</sup>	u/s	Adult												
Lamprey	d-s	Juvenile												
Longfin & shortfin eel	To	Glass												
Longfin eel <sup>1,2,22</sup>	u/s	Juvenile												
Longfin eel <sup>1</sup>	d-s	Adult												
Shortfin eel <sup>1,2,22</sup>	u/s	Juvenile												
Shortfin eel <sup>1</sup>	d-s	Adult												
Common smelt (sea) <sup>1</sup>	u/s	Juvenile												
	d-s	Larvae												
Inanga <sup>5,22</sup>	u/s	Juvenile												
	d-s	Larvae												
Giant kokopu <sup>1,2,4,22,25</sup>	u/s	Juvenile												
	d-s	Larvae												
Shortjaw kokopu <sup>1,2,4,22</sup>	u/s	Juvenile												
	d-s	Larvae												
Banded kokopu <sup>1,2,22</sup>	u/s	Juvenile												
	d-s	Larvae												
Koaro <sup>1,1</sup>	u/s	Juvenile												
	d-s	Larvae												
Torrentfish <sup>1,25</sup>	u/s	Juvenile												
	d-s	Larvae												
Redfin bully <sup>1,22</sup>	u/s	Juvenile												
	d-s	Larvae												
Common bully <sup>1,22,25</sup>	u/s	Juvenile												
	d-s	Larvae												
Bluegill bully <sup>1</sup>	u/s	Juvenile												
	d-s	Larvae												
Giant bully <sup>1</sup>	u/s	Juvenile												
	d-s	Larvae												

Table 13-13 Fish migration calendar for the Tasman District

**Fish spawning calendar for Tasman District showing the peak and range periods of spawning activity and spawning habitat.**

Species	Spawning habitat	Summer			Autumn			Winter			Spring		
		Dec	Jan	Feb	Mar	Apr	May	Jun	Jul	Aug	Sept	Oct	Nov
Lamprey	Upper catchment												
Long & shortfin eel	Pacific ocean												
Long & shortfin eel	Pacific ocean												
Common smelt (sea run)	Sand banks of rivers												
Inanga	Tidal estuary edge vegetation												
Giant kokopu	Mid-low reaches (unconfirmed)												
Banded kokopu	Stream margins at flood among vegetation and debris												
Shortjaw kokopu	Stream bank rocks, debris and vegetation during flood												
Koaro	Cobbles at stream edge												
Dwarf galaxias	Small cobbles instream												
Brown mudfish	Freshwater wetlands												
Torrentfish	Lowland rivers/estuaries												
Redfin bully	Under rocks in flowing water												
Common bully	Under firm flat surfaces												
Bluegill bully	Similar to other bullies												
Giant bully	Estuaries (unconfirmed)												
Upland bully	Under large flat rocks												



Key:  Peak  Range

Table 13-14 Fish spawning calendar for Tasman District



### 13.9 Discharge design for T-bar floating decant

Stream channel erosion is an issue for storage practices that release site runoff as concentrated flow where streams are the receiving environment.

Sediment retention ponds and decanting earth bunds are required to use floating decant systems to drain the live storage (available storage volume for storm runoff) over an extended period of time (ie 24 hours).

Chapter 9, section 9.1.5 discusses use of standardised decant pipes that achieve a discharge rate of 4.5 litres per decant. This section outlines the methodology for determining the required number of holes in a floating T-bar decant that is not based on the standard design.

The volume that should be available for live storage is 70% of the total volume on which the storage practice size is based. This ensures that there will be water in the bottom of the device to reduce resuspension of already trapped sediments.



Figure 13-3 Sediment Pond with Floating Decants also Showing Live Storage

The floating decant design is based on using holes in the decant that have a discharge rate of 0.0225 l/s for 10 mm diameter holes. Discharge from the individual holes does not vary as decants will be floating and therefore provide constant head.

Providing 24-hour detention and release to protect stream physical structure is done in the following manner:

1. Take 70% of the total volume of required storage (V) (refer section 13.7.2) to determine the live storage volume.
2. Divide the total volume by 86,400 seconds (number of seconds in a day) and convert the volume to litres (multiply by 1000). This will give the maximum flow rate to achieve detention over a 24-hour period.
3. Divide the flow rate by 0.0225 l/s to obtain the number of holes that are necessary.

This approach provides the extended detention to ensure adequate water quality treatment. The number of holes should not exceed the number calculated.

#### 13.9.1 Discharge rate example calculation

Example for Takaka (following on from previous storage volume calculation example)

- Take 70% of the total storage volume calculated, to calculate the live storage volume (0.7 of 35:0m<sup>3</sup> = 245 m<sup>3</sup>).
- Divide the total volume by 86,400 seconds (number of seconds in a day) and convert the volume to litres. This will give the maximum flow rate to achieve detention over a 24-hour period = 0.0028 m<sup>3</sup>/s or 2.8 l/s.

Divide the flow rate by 0.0225 l/s to obtain the number of holes that are necessary = 126 holes.

## 13.10 Bibliography

Reference	Details
ARC 1999	Auckland Regional Council, March 1999, Erosion & Sediment Control Guidelines for Land Disturbing Activities in the Auckland Region, Technical Publication No. 90.
ARC 2000	Auckland Regional Council, April 2000, Low Impact Design Manual for the Auckland Region, Technical Publication No. 124.
ARC 2004	Auckland Council's Technical Publication 227 " <i>The Use of Flocculants and Coagulants to Aid the Settlement of Suspended Sediment in Earthworks Runoff : Trials, Methodology and Design [draft]</i> " June 2004.
BA 2004	New Zealand Building Act 2004. (refer Ministry of Business, Innovation and Employment).
Barret et al 1995	Barrett, M.E. et al, 1995, An Evaluation of the Use and Effectiveness of Temporary Sediment Controls, Technical Report CRWR 261, The University of Texas at Austin, Center for Research in Water Resources, Austin Texas.
BOPRC 2010	Bay of Plenty Regional Council, 2010, Environmental Guideline 2010/01 – Erosion and Sediment Control Guidelines for Land Disturbing Activities.
Caltrans 2002	Caltrans, September 2002, Project Planning and Design Guide, Construction Site Best Management Practices (BMPs) Guide, Storm Water Quality Handbooks, State of California Department of Transportation.
Case Law 2002	Federated Farmer of New Zealand (North Canterbury Province Inc) v Canterbury Regional Council. July 2002.
Case Law 2003	MacLaurin v Gisborne District Council. September 2003.
Case Law 2005	Wellington Regional Council v Ohiro Properties Ltd. June 2005.
Case Law 2009	Southland Regional Council v Southern Pastoral Holdings Ltd and Drummond. March 2009.
Cawthron 2010	Cawthron, 2010, Spatial Delineation of the Motueka River Plume Influence in Tasman Bay Based on Seabed Characteristics, Cawthron Report No. 1697, January 2010.
Claytor 1997	Claytor, R., 1997, Practical Tips for Construction Site Phasing, Watershed Protection Techniques 2(3).
Dane County 2007	Dane County, 2007, Dane County Erosion Control and Stormwater Management Manual.
DoL 1995	Department of Labour. October 1995. Guidelines for the Provision of Facilities and General Safety In The Construction Industry.
ECAN 2007	Environment Canterbury, 2007. Erosion and sediment control guidelines for the Canterbury region. Report No. R06/23, Canterbury Regional Council, Christchurch, New Zealand. ISBN No. 1-86937-607-2.
USEPA 1993	United States Environmental Protection Agency, 1993, Guidance Specifying Management Measures for Sources of Nonpoint Pollution in Coastal Waters, EPA 840-B-92-002, United States Environmental Protection Agency, Office of Water, Washington DC.
EPA	New Zealand Environmental Protection Authority – website: <a href="http://www.epa.govt.nz">www.epa.govt.nz</a> .
Gibbs & Hewitt 2004	Gibbs, M., Hewitt, J., May 2004, Effects of sedimentation on macrofaunal communities: a synthesis of research studies for ARC, NIWA, prepared for Auckland Regional Council, Technical Publication No. 264.

Reference	Details
Goldman et al 1986	Goldman, S.J., Jackson, K., Bursztynsky, T.A., 1986, Erosion and Sediment Control Handbook, McGraw-Hill Book Company.
Harding 1990	Harding, M.V., 1990, Erosion Control Effectiveness: Comparative Studies of Alternative Mulching Techniques, Environmental Restoration pp 149-156.
Hicks 1994	Hicks, Murray, July 1994, Storm Sediment Yields from Basins with Various Landuses in Auckland Area, prepared for Auckland Regional Council, NIWA.
HIRDS	NIWA High Intensity Rainfall Design System (HIRDS) website: <a href="http://hirds.niwa.co.nz/">http://hirds.niwa.co.nz/</a>
Joy 2009	Joy, M., 2009. Temporal and Land-Cover Trends In Freshwater Fish Communities In New Zealand's Rivers: An Analysis Of Data From New Zealand Freshwater Fish Database – 1970-2007. Prepared for Ministry for the Environment.
Kouwen 1990	Kouwen, N., 1990, Silt Fences to Control Sediment on Construction Sites, Technical Publication MAT-90-03, Ontario Ministry of Transportation, Research and Development Branch, Downsview, Ontario, Canada.
Krausse et al. 2001	Krausse, M., Eastwood, C., & Alexander, R. R. (2001). Muddied waters: Estimating the national economic cost of soil erosion and sedimentation in New Zealand. Palmerston North, New Zealand: Landcare Research.
Larcombe 2009	Larcombe, M., June 2009, Summary of Sediment Retention Pond Performance, Mass Discharges of Sediment to the Orewa Estuary Receiving Environment and Effects of Sediment Discharge to the Orewa Estuary for the 2008-2009 Earthworks Season, Report submitted to ARC for a sediment control consent.
Loher et al 2004	Lohrer, A.M., Thrush, S.F., Hewitt, J.E., Berkenbusch, K., Ahrens, M., Cummings, V.J., 2004, Terrestrially derived sediment: response of marine macrobenthic communities to thin terrigenous deposits, Marine Ecology Progress Series, Volume 273: 121-138.
MBIE 2011	Compliance Document for New Zealand Building Code Clause E1 Surface Water 2011(refer Ministry of Business, Innovation and Employment).
Mead & Moores 2004	Mead and Moores, A; 2004. Estuary Sedimentation: A review of estuarine sediment in the Waikato Region. Prepared for Environment Waikato. ISBN: 1172-4005.
MfE 2010	Preparing for future flooding: A guide for local government in New Zealand. Ministry for the Environment. May 2010. Publication number: ME 1012.
MFE 2011	Contaminated Land Management Guidelines No. 1–Reporting on Contaminated Sites in New Zealand, Wellington, Ministry for the Environment (Revised 2011).
MFE 2012	National Environmental Standard for Assessing and Managing Contaminants in Soil to Protect Human Health (NES-SC) 1 January 2012 (refer Ministry for the Environment).
Moores & Pattinson 2008	Moores, J., Pattinson, P., July 2008, Performance of a Sediment Retention Pond Receiving Chemical Treatment, prepared for Auckland Regional Council, NIWA.
NIWA 1997	NIWA, 1997, Sediment Loadings from the Proposed Countryside Living Zone, prepared for ARC.
NIWA 2007	<i>Storey R &amp; J Quinn. When the rivers run dry: invertebrate communities in intermittent streams. Water &amp; Atmosphere 15(2) 2007.</i>
NZTA 2010	New Zealand Transport Agency, August 2010, Draft Erosion and Sediment Control Standard for State Highway Infrastructure.
ODEQ 2005	Oregon Department of Environmental Quality, April 2005, Erosion and Sediment Control Manual, prepared by GeoSyntec Consultants.

Reference	Details
Quinn 2000	Quinn, J.M. 2000: Effects of pastoral development. In: New Zealand Stream Invertebrates: Ecology and Implications for Management, edited by K.J. Collier and M.J. Winterbourn. New Zealand Limnological Society, Christchurch, New Zealand. P. 208-229.
Richards 2003	Richards, D.T.W., 2003, Geomorphological and environmental studies of karst, northwest Nelson, New Zealand, University of Canterbury.
RMA 1991	Resource Management Act 1991, Public Act 1991 No 69, Reprint as at 8 December 2009.
Robertson & Stevens 2009	Robertson, B., Stevens, L., March 2009, State of the Environment Report Estuaries of Tasman District, prepared for Tasman District Council.
Rowell 1994	Rowell, David, 1994, Soil Science: Methods and Applications, Longman Scientific and Technical publishers, Longman Group UK Limited.
Senior et al 2003	Senior, A., et.al, August 2003, Risks to Estuarine Biota under Proposed Development in the Whitford Catchment, prepared by NIWA for Manukau City Council and Auckland Regional Council, Technical Publication #205.
Swales et al 2002	Swales et.al, December 2002, Evidence for the Physical Effects of Catchment Sediment Runoff Preserved in Estuarine Sediments: Phase II (field study), NIWA and Landcare Research Ltd., prepared for Auckland Regional Council, Technical Publication No. 221.
TDC 2005	Provisions for Wetlands – Tasman Resource Management Plan Guide No. V – 20, 2005.
TDC 2009	James, T. 2009 Best Practice Guidelines for Waterway Crossings. Tasman District Council.
TDC 2010	TDC 2010, Our Freshwaters—River Water Quality 2010, Summary Report, Tasman District Council.
TDC 2011	James, T. and Kroos, T. State of the Environment Report: The Health of Freshwater Fish Communities in Tasman District. September 2011. Tasman District Council Report #: 11001.
TDC 2013	NTLDM.
TRMP	Tasman Resource Management Plan. Tasman District Council.
NRMP	Nelson Resource Management Plan. Nelson City Council.
Urich 2002	Urich, P., B., June 2002, Land Use in Karst Terrain: Review of Impacts of Primary Activities on Temperate Karst Ecosystems, Department of Conservation, Science for Conservation 198.
UW ERC 2010	University of Wisconsin Environmental Resources Centre. Water Action Volunteers' Stream Monitoring Fact Sheets – Transparency. (Graph is an un-calibrated impact assessment model based on Newcombe, C. P., and J. O. T. Jensen. 1996. Channel suspended sediment and fisheries: a synthesis for quantitative assessment of risk and impact. North American Journal of Fisheries Management. 16: 693-727).
Williamson 1993	Williamson, R.R., 1993, Urban Runoff Data Book: a manual for the preliminary evaluation of urban stormwater impacts on water quality, Water Quality Centre Publication No. 20, NIWA.
Young et al 2010	Young RG, Doehring K, James T, 2010. State of the Environment Report. River Water Quality in Tasman District.
Zhu et al 1999	Zhu, J., Dabney, S.M., Flannagan, D.C., Updating Slope Topography During Erosion Simulations with the Water Erosion Prediction Project. 1999.



**Get it right and enjoy the benefits.**



*Photo credit R. Scherer*

